

Singer 68-1
Singer 68-4
Singer 68-6
Singer 68-7
Singer 68-9
Singer 68-10
Singer 68-11
Singer 68-12
Singer 68-14
Singer 68-15
Singer 68-16
Singer 68-17
Singer 68-18
Singer 68-19
Singer 68-20
Singer 68-21
Singer 68-22
Singer 68-23
Singer 68-24
Singer 68-25
Singer 68-26
Singer 68-27

Singer 68-28
Singer 68-29
Singer 68-30
Singer 68-31
Singer 68-32
Singer 68-33
Singer 68-34
Singer 68-36
Singer 68-37
Singer 68-38

Form 18133, Revised
(738)
Printed in U. S. A.

LIST OF PARTS



MACHINES
Nos. 68-1, 68-4, 68-6, 68-7,
68-9 to 68-12, 68-14 to
68-34 and 68-36
to 68-38

THE SINGER MANUFACTURING COMPANY

From the library of: Diamond Needle Corp

INSTRUCTIONS FOR OILING

To ensure easy running and prevent unnecessary wear of the parts which are in movable contact, the machine requires oiling and when in continuous use, "TYPE B" or "TYPE D" OIL, sold only by Singer Sewing Machine Company, should be applied at least twice each day to all oil holes marked "OIL". The loose pulley at the end of the machine must be oiled frequently through the hole, in the center of the large screw head at the end of the shaft. The shuttle bearing in the shuttle race should be oiled each time a bobbin is replaced.

Copyright, U. S. A., 1913, 1914, 1915, 1916, 1917,
1918, 1920, 1921, 1922, 1923, 1926, 1933 and 1938

by The Singer Manufacturing Co.

All Rights Reserved for all Countries

INDEX

	PAGE
ATTACHMENTS AND ACCESSORIES.....	128
BOBBIN WINDER FOR 2073.....	129
" " " 2996.....	129
CLAMPS.....	125
IRON BASE.....	127
MACHINE No. 68-1.....	9
" " 68-4.....	21
" " 68-6.....	22
" " 68-7.....	22
" " 68-9.....	23
" " 68-10.....	24
" " 68-11.....	26
" " 68-12.....	27
" " 68-14.....	28
" " 68-15.....	29
" " 68-16.....	30
" " 68-17.....	31
" " 68-18.....	32
" " 68-19.....	33
" " 68-20.....	35
" " 68-21.....	37
" " 68-22.....	39
" " 68-23.....	41
" " 68-24.....	42
" " 68-25.....	44
" " 68-26.....	47
" " 68-27.....	50
" " 68-28.....	52
" " 68-29.....	64
" " 68-30.....	64
" " 68-31.....	65
" " 68-32.....	67
" " 68-33.....	78
" " 68-34.....	90
" " 68-36.....	102
" " 68-37.....	113
" " 68-38.....	114
NUMERICAL LIST OF PARTS.....	139
OBSELETE PARTS.....	133
PROTECTOR.....	130
STARTING LEVER AND FOOT LIFTER PARTS.....	131
STARTING LEVER ROCK SHAFT.....	131
TABLE BELT GUIDE.....	132
TAPE HOLDER.....	128
THREAD LUBRICATOR.....	132
THREAD UNWINDER.....	133

INSTRUCTIONS FOR ORDERING

In ordering from this list, use ONLY the part NUMBER in the FIRST column.

The number stamped on a Sewing Machine Part is in every case the number of the single part only.

Every combination of parts sent out as such has its specific number, which, although not stamped on the parts, must be used when ordering the combination.

Each number always indicates the SAME PART in whatever list it appears, or for whatever machine.

The letters after some of the numbers indicate the style of finish only, as follows:

A-Hardened, Polished, Nickel Plated and Buffed
 A.A-Buffed and Chromium Plated
 A.B-Hardened, Polished, Buffed and Chromium Plated
 B-Polished, Nickel Plated and Buffed
 C-Hardened Only
 C.R-Hardened and Merlized
 D-Polished Only
 E-Soft, Not Polished
 F-Hardened and Polished
 F.J-Hardened, Polished and Nickel Plated
 G-Bright Rumbled and Nickel Plated
 H-Blued
 J-Nickel Plated Only
 K-Hardened and Nickel Plated
 L-Brass Plated
 M-Oxidized
 N-Japanned, Dull
 P-Japanned, Bright
 P.P-Wrinkle Finish
 R-Merlized
 S-Cadmium Plating
 T-Copper Plated
 T.A-Hardened, Polished, Copper and Nickel Plated and Buffed
 T.B-Copper and Nickel Plated and Polished
 T.J-Copper and Nickel Plated Only
 T.K-Hardened, Copper and Nickel Plated
 T.L-Copper and Brass Plated
 T.M-Copper Plated and Oxidized
 U-Zinc Plated
 V-Silver Plated
 W-Polished and Nickel Plated
 X-Black Oxide, for Iron and Steel
 X.C-Hardened and Black Oxide, for Iron or Steel
 Y-Black Nickel Plated Only
 Z-Chromium Plated
 Z.A-Hardened, Polished, Nickel Plated, Buffed and Chromium Plated
 Z.B-Polished, Nickel Plated, Buffed and Chromium Plated
 Z.C-Hardened and Chromium Plated
 Z.D-Polished and Chromium Plated
 Z.G-Bright Rumbled, Nickel Plated, Bright Rumbled and Chromium Plated
 Z.J-Nickel and Chromium Plated
 Z.T-Copper and Chromium Plated

These letters MUST BE USED when they appear in the list; and AFTER the number as in the list.

In this series:

1 to 1500, 50001 to 51500 and 140001 to 142000
 are Screw Numbers
 1501 to 1800 and 51501 to 51800 are Nut Numbers
 1801 to 2000 and 51801 to 52000 are Roller Numbers
 2001 to 50000 and 52001 to 140000 and 142001 to
 190000 are Sewing Machine Parts, 190001 and upward
 are numbers of Electrical Parts.

The figures in the second column refer only to the plates, illustrating the parts, and are NOT TO BE USED in ordering.

Parts marked with an asterisk (*) are furnished only when repairs are made at factory.

LIST OF PARTS COMPLETE FOR

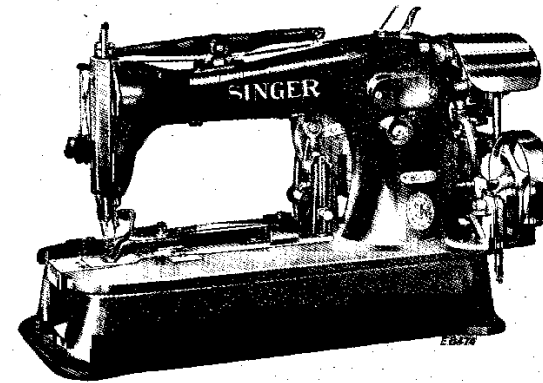

MACHINE No. 68-1

FOR CLOTHING. MAKES PARALLEL STITCHES IN FOUR-HOLE
 BUTTONS AND CAN BE ADJUSTED FOR TWO-HOLE AND
 BAR BUTTONS. MAKES EIGHTEEN STITCHES AND THREE
 TYING STITCHES.

NO.	PLATE	NAME
*63989	—	Arm with 4449, 15404, 17844 and two each 164x and 15405.....
2002	3722	Arm Dowel Pin.....
4448	3722	" Oil Tube for intermediate bearing...
880e	3724	" Screw.....
17702	3728	" Shaft.....
17703	3711	" " Bushing (back).....
50333c	3788	" " " " Adjusting Screw.....
1520e	3724	" " " " " " " ".....
		Nut.....
*4449	—	Arm Shaft Bushing (front).....
124674	20334	" Side Cover.....
190j	3710	" " " Screw.....
*17704	—	Bed.....

From the library of: Diamond Needle Corp

NO.	PLATE	NAME
18498	7202	Belt Cover.....
39290	3743	" " Bracket with 184E and 17741..
184E	3753	" " " Screw Stud.....
17741	3701	" " " Stud.....
217J	3731	" " Screw.....
39222	3725	" Shifter.....
63976	7235	" " Clamp.....
1255J	3726	" " " Screw.....
17706	3704	Button Clamp (left) with 17723, for 17898
17707	3704	" " (right) with 17723, for 17898
17899	3708	" " (left) with 17723, for 17904
17900	3708	" " (right) with 17723, for 17904
39238	3747	" " (left) with 9311 and 17723, for 63928.....
39239	3747	Button Clamp (right) with 9311 and 17723, for 63928.....
17901	3704	Button Clamp Arm with 17711, 17714 and 23227, for 17898 and 17904.....
63927	7205	Button Clamp Arm with 17714 and 63788, for 63928.....
17710	3704	Button Clamp Arm Hinge Plate.....
1176J	3704	" " " " " Screw....
17711	3704	" " " Hook for 17901.....
63788	7205	" " " " " 63927.....
1175J	3704	" " Hinge Screw.....
17708	3710	" " Lifter with 17866.....
190J	3710	" " " Screw.....
17712	3710	" " Pressure Spring for 17898 and 17904.....
39241	3748	Button Clamp Pressure Spring for 63928..
17713	3710	" " " " Bracket
1177J	3710	" " " " " "
		Screw.....
17714	3704	Button Clamp Pressure Spring Guide Block.....
1178J	3710	Button Clamp Pressure Spring Screw.....
20437	20333	" " " " Washer
17716	3705	" " Spreader for 17898 and 17904.....
39242	3748	Button Clamp Spreader for 63928.....
17717	3705	" " " Lever.....
50237K	3705	" " " " H i n g e Screw.....
1180J	3705	Button Clamp Spreader Lever Locking Thumb Screw.....
17718	3705	Button Clamp Spreader Lever Locking Thumb Screw Washer.....

NO.	PLATE	NAME
1182J	3705	Button Clamp Spreader Screw.....
17719	3705	" " " Spring.....
1181J	3705	" " " " Screw Stud
17720	3705	" " " Steady Pin.....
17721	3705	" " Spring, for flat buttons, for 17898.....
17938	3705	Button Clamp Spring, for stud back but- tons, for 17898.....
17902	3708	Button Clamp Spring, for flat buttons, for 17904.....
17939	3708	Button Clamp Spring, for stud back but- tons, for 17904.....
39244	3747	Button Clamp Spring (left) for flat but- tons, for 63928.....
39245	3747	Button Clamp Spring (right) for flat but- tons, for 63928.....
39246	3748	Button Clamp Spring (left) for stud back buttons, for 63928.....
39247	3748	Button Clamp Spring (right) for stud back buttons, for 63928.....
39340	3757	Button Clamp Spring for 39341.....
39341	—	" " " 39340 with 39342, for flat or stud back buttons, for 17904..
39342	3757	Button Clamp Spring Plate for 39341....
236J	3705	" " " Screw for 17898 and 17904.....
229J	3702	Button Clamp Spring Screw for 63928....
23227	3705	" " " Steady Pin for 17901
9311	3747	" " " " " " 39238 and 39239.....
17722	3705	Button Clamp Stop with two 17720, for 17898.....
17903	3708	Button Clamp Stop with two 17720, for 17904.....
39248	3748	Button Clamp Stop with two 17720, for 63928.....
1183J	3705	Button Clamp Stop Screw.....
17723	3704	" " Stud.....
17898	3703	Button Clamp (universal) complete, for 14 to 36 line buttons, Nos. 236J, 1180J, 1181J, 1182J, 1183J, 17706, 17707, 17716 to 17719, 17721 or 17938, 17722, 17901, 50237K and two 1175J.....
17904	—	Button Clamp (universal) complete, for 26 to 46 line buttons, Nos. 236J, 1180J, 1181J, 1182J, 1183J, 17716 to 17719, 17899 to 17901, 17902 or 17939, 17903, 50237K and two 1175J.....

NO.	PLATE	NAME
63928	---	Button Clamp (universal) complete, for 10 to 50 line thin buttons, Nos. 1180J, 1181J, 1182J, 1183J 17717 to 17719, 39238, 39239, 39242, 39244 or 39246, 39245 or 39247, 39248, 50237K, 63927 and two each 229J and 1175J.....
4292	3711	Crank Connecting Rod with two 145E....
	145E 3726	" " " Cap Screw.....
	375c 3724	" " " Hinge Screw.....
	1518E 3718	" " " " " Nut..
	17724 3711	Face Plate.....
*63736	---	" " 17724 with 2105.....
17725	---	Face Plate complete, Nos. 448c, 2107, 2127, 56791, 63736 and two 233J.....
	164J 3724	Face Plate Screw.....
	2107 3722	" " Thread Guard.....
	233J 3722	" " " " Screw.....
17726	3714	Feed Across Connection Adjusting Stud
1649c	3714	" " " " " " Nut (left).....
1650c	3714	Feed Across Connection Adjusting Stud Nut (right).....
	896E 7235	Feed Across Connection Cap Screw.....
63940	7235	" " " (lever end) with two 896E.....
63941	---	Feed Across Connection (lever end) 63940 with 55381.....
55381	7235	Feed Across Connection (lever end) Ball Stud.....
	1185c 3714	Feed Across Connection (lever end) Ball Stud Set Screw.....
63942	7235	Feed Across Connection (regulator end) with two 896E.....
63943	---	Feed Across Connection (regulator end) 63942 with 63944.....
63944	7235	Feed Across Connection (regulator end) Ball Stud.....
17729	3713	Feed Across Lever with 1185c and 1952..
17731	3713	" " " Bracket with 17732 and three 160J.....
*17732	---	Feed Across Lever Bracket Cap.....
	160J 3714	" " " " " Screw....
	8589 3722	" " " " Dowel Pin....
	1177J 3710	" " " " Screw.....
17737	3714	" " " Hinge Stud.....
	160J 3714	" " " " " Clamping Screw.....

NO.	PLATE	NAME
1952	3714	Feed Across Lever Roller and Stud.....
17735	3701	" " Plate with 17741.....
1186c	3701	" " " Screw.....
1651J	3701	" " " " Nut.....
17736	3713	" " Regulator.....
50599D	7235	" " " Adjusting Screw Stud.....
	1676c 3746	Feed Across Regulator Adjusting Screw Stud Nut.....
46244	7235	Feed Across Regulator Adjusting Screw Stud Nut Washer (fibre).....
17738	3715	Feed Across Regulator Adjusting Screw Stud Nut Washer (steel).....
	1188D 3724	Feed Across Regulator Hinge Screw.....
	17740 3715	" " " Link.....
	1189E 3715	" " " " Screw Stud..
	17741 3701	" " " " Stud.....
	17751	" Cam with two each 1192c, 17874 and four 190J.....
	18415 ✓ 3746	Feed Cam Driving Worm with 1441c and 1442c.....
	1442c 3746	Feed Cam Driving Worm Position Screw..
	1441c 3746	" " " " Set Screw.....
	17797 ✓ 3713	" " " " Wheel with 453c
	18384 3753	" " " " " Pin.....
	453c 3715	" " " " " Set Screw
	18384 ✓ 3753	" " Pin.....
	1192c 3724	" " Set Screw.....
	62155 ✓ 20334	" " Shaft.....
	1653c 3724	" " Nut.....
	17800 3701	" Plate (thin) for flat buttons.....
	17923 3701	" " (thick) for round bottom buttons
	*39259 3716	" " Carrier Bar.....
	39260	" " " " 39259 with 934J, 1195E, 8505, 17743, 17802, 17804, 18368, two 7476 and four 17806.....
	17802 3701	Feed Plate Carrier Bar Block.....
	17803 3701	" " " " " Cover.....
	17804 3701	" " " " " Rivet.....
	7476 3701	" " " " " Steady Pin..
	17805 3714	" " " " " Pivot Block.....
	1194D 3714	" " " " " Screw
	18368 3714	" " " " " Plate.....
	934J 3714	" " " " " Screw.....
	1654c 3701	" " Nut.....
	17806 3701	" " Position Stud.....
	1195E 3701	" " Screw Stud.....
	8505 20333	" " " " Rivet.....

13-65

18.85

35

12.20

From the library of: Diamond Needle Corp

NO.	PLATE	NAME
17742	3713	Feed Regulator with 1953.....
17744	3715	" " Hinge Stud.....
17743	3715	" " Post.....
1953	3715	" " Roller and Screw Stud with 1655c and 14017.....
1655c	3715	Feed Regulator Roller and Screw Stud Nut
14017	3715	" " " " " " " " " " " Washer.....
1190c	3715	Feed Regulator Stop Screw.....
17745	3715	" " Swivel.....
1191D	3715	" " Thumb Screw.....
17807	3717	Knife (needle thread).....
17808	3717	" (shuttle thread).....
*63806	—	" Bar.....
63807	—	" " 63806 with 63808 63809 and two 17814.....
39299	3752	Knife Bar 63807 with 704c and 39300....
17810	3700	" " Cap (back).....
690J	3748	" " " " Screw.....
17811	3700	" " " (front).....
160J	3714	" " " " Screw.....
39262	3754	" " " (intermediate).....
39263	—	" " " " 39262 with 1328E, 1517E, 39264 and 39265.....
690J	3748	Knife Bar Cap (intermediate) Screw.....
39264	3754	" " " " Stop Pin
1328E	3754	" " " " " " " " " " " Screw Bushing.....
1517E	3754	Knife Bar Cap (intermediate) Stop Pin Screw Bushing Nut.....
39265	3754	Knife Bar Cap (intermediate) Stop Pin Spring.....
63808	7206	Knife Bar Connection.....
17814	3700	" " " " Rivet.....
17915	3700	" " " " Slide Block.....
63809	—	" " " " " " 17915 with 63810.....
63810	7206	Knife Bar Connection Slide Block Stud...
39297	3753	" " Driving Lever with 190J, 1420E, 17919 and 39298.....
1382F	3753	Knife Bar Driving Lever Hinge Screw....
1681c	3753	" " " " " " " " " " " Nut
39298	3753	" " " " " " Lock Stud.....
17919	3700	" " " " " " Spring
190J	3710	" " " " " " " " " " " Screw.....

NO.	PLATE	NAME
1420E	3753	Knife Bar Driving Lever Lock Stud Stop Screw.....
17820	3716	Knife Bar Extension.....
17750	—	" " " " 17820 with 17821 and two 17822.....
190J	3710	Knife Bar Extension Screw.....
7071	3746	" " " " Washer.....
17821	3717	" " Rack.....
17822	3717	" " " Rivet.....
39300	3754	" " Stop Block.....
19793	3746	" " " " Dowel Pin.....
704C	3754	" " " " Screw.....
39235	3758	" " Cam Lever Body.....
39409	—	" " " " 39235 with 39460..
39329	3758	Knife Cam Lever complete, Nos. 19793 and 39409.....
39332	3758	Knife Cam Lever Bracket with 1177J.....
8589	3722	" " " " Dowel Pin.....
1177J	3710	" " " " Screw.....
50029c	3759	" " " Hinge Screw.....
18471	3759	" " " " " Bushing
18472	—	" " " " " " " " " " " 18471 with 50029c.....
1177J	3710	Knife Cam Lever Hinge Screw Bushing Clamping Screw.....
1980	3759	Knife Cam Lever Roller and Screw Stud with 1654c.....
1654c	3701	Knife Cam Lever Roller and Screw Stud Nut.....
39330	3759	Knife Cam Lever Slide with 1980.....
39460	—	" " " " 39330 with 1255J and 39331.....
1255J	3726	Knife Cam Lever Slide Screw.....
39331	3759	" " " " " Washer.....
19793	3746	" " " " Steady Pin.....
68710	—	" Holder.....
39269	3755	" " 68710 with 1336c, 17826, 17830 and two 7298.....
*39488	—	Knife Holder 39269 with 1198c, 17807, 17808 and 17829.....
17826	3717	Knife Holder Pinion.....
7298	3717	" " " Dowel Pin.....
17827	3717	" " " Stud.....
39270	3755	" " " " Bracket with 17827.....
50018F	3753	Knife Holder Pinion Stud Bracket Screw
1698E	3753	" " " " " " " " " " " Nut.....

NO.	PLATE	NAME
1198c	3717	Knife Screw.....
17829	3717	" Thread Holder.....
17830	3717	" " " Position Pin.....
39291	3756	" " Retainer with 39277 and two 39278.....
39277	3755	Knife Thread Retainer Finger.....
39278	3755	" " " Rivet.....
1336c	3755	" " " Screw Stud.....
17831	3716	Needle Bar with 237F.....
*39203	3718	" " Connecting Link.....
63756	—	" " " " 39203 with 21629.....
377c	3718	Needle Bar Connecting Link Hinge Screw
1518E	3718	" " " " " "
		Nut.....
21629	3718	Needle Bar Connecting Stud with 155c...
155c	3718	" " " " Set Screw...
39350	3743	" " Thread Nipper Driving Lever (adjustable) with 39351 and two 335r..
39351	3759	Needle Bar Thread Nipper Driving Lever Extension.....
335J	3759	Needle Bar Thread Nipper Driving Lever Extension Screw.....
1196c	3721	Needle Bar Thread Nipper Driving Lever Hinge Screw.....
39352	3743	Needle Bar Thread Nipper Driving Lever Spring.....
17834	3718	Needle Bar Thread Nipper Lever with 17835.....
17835	3718	Needle Bar Thread Nipper Lever Bushing
1200D	3718	" " " " " Hinge Screw.....
39276	3754	Needle Bar Thread Nipper Lever Spring
1329J	3754	" " " " " "
		Screw.....
17837	3716	Needle Bar Thread Nipper Rod.....
17838	3718	" " " " " Adjusting Stud.....
1651E	3701	Needle Bar Thread Nipper Rod Adjusting Stud Lock Nut.....
17839	3718	Needle Bar Thread Nipper Rod Arm with 196r.....
196F	3718	Needle Bar Thread Nipper Rod Arm Set Screw.....
17840	3716	Needle Bar Thread Nipper Rod Support
190J	3710	" " " " " "
		Screw.....

NO.	PLATE	NAME
237F	3724	Needle Set Screw.....
4304	3711	Oscillating Rock Shaft with 4784.....
3052	3711	" " " Hinge Pin.....
1513J	3724	" " " " " Nut.....
635c	3724	" " " " " Screw
		Bearing.....
1513J	3724	Oscillating Rock Shaft Hinge Pin Screw
		Bearing Nut.....
4784	3702	Oscillating Rock Shaft Oil Pad.....
3053	3716	" Shaft.....
*15160	—	" " Crank for 15161.....
15425	—	" " " " 15162.....
*15161	—	Oscillating Shaft Crank complete, Nos. 462c, 1519E, 15160 and 15171.....
15162	3702	Oscillating Shaft Crank complete, Nos. 1519E, 15171, 15425 and two 462c.....
2049	3702	Oscillating Shaft Crank Pin.....
462c	3702	" " " Set Screw.....
15170	3702	" " " Slide Block.....
226J	7215	" " " " " C a p Screw.....
12424	3702	Oscillating Shaft Crank Slide Block Cap Screw Washer.....
1035c	3702	Oscillating Shaft Crank Slide Block Screw Stud.....
1519E	3702	Oscillating Shaft Crank Slide Block Screw Stud Nut.....
15171	3702	Oscillating Shaft Crank Slide Block com- plete, Nos. 226r, 1035c, 12424 and 15170
2058	3716	Presser Bar.....
17841	3718	" " Collar with two 196r.....
196F	3718	" " " Set Screw.....
17842	3718	" " Guide Bracket with 453c.....
453c	3715	" " " " Set Screw.....
17843	3711	" " Lifting Lever.....
17844	3711	" " " " Bracket.....
164E	3724	" " " " " Screw..
1201c	3700	" " " " Hinge Screw...
17845	3716	" " " " Rod.....
17846	—	" " " " " Chain.....
32675	20333	" " Spring.....
63975	7236	Pulley (loose) 2 3/4 in. diam.....
68712	20340	Pulley (loose) 2 3/4 in. diam., with 200584d.
68713	—	" " 68712 with 68714.....
68714	20340	" " Ball Bearing.....
68715	20339	" " Bushing.....
51387R	20339	" " Cap Screw.....
200584D	20339	" " Oil Plug Screw.....
68716	20340	" (tight) 2 3/4 in. diam.....
68720	—	" " 68716 with 1206c and 17854
2022	3722	" " Pin.....

18 PARTS FOR MACHINE No. 68-1

NO.	PLATE	NAME
68717	—	Pulleys (ball bearing) complete, Nos. 51387R, 68713, 68715 and 68720.....
2073	3702	Shuttle Bobbin.....
2211	3702	" " Retaining Spring.....
2212	3702	" " " " Rivet....
*39295	—	" Body with 398E, 2082, 2084, 2211 and two 2212.....
*2075	—	Shuttle Cover.....
*44001	—	" " 2075 with 112E, 466H, 2078, 2080, 2086 and 2090.....
2076	3702	Shuttle Cover Hinge Pin.....
2078	3702	" Delivery Eye Thread Guard.....
2080	3702	" " " " Rivet.....
2082	3702	" Main Spring.....
398E	3702	" " " Screw.....
2084	3702	" " " Steady Pin.....
466H	3702	" Tension Regulating Screw.....
2086	3702	" " Spring.....
2090	3702	" " Plate.....
112E	3702	" " " Screw.....
39296	3702	Shuttle complete, Nos. 2073, 2076, 39295 and 44001.....
39487	3702	Shuttle Driver with two 457c.....
39209	3746	" " " 662D, 39210 and two 457c, for purl stitch.....
2049	3702	Shuttle Driver Pin.....
457c	3702	" " Set Screw.....
39210	3746	" " Thread Pull-off, for purl stitch.....
662D	3746	Shuttle Driver Thread Pull-off Screw.....
17746	3719	" Race Back with 17747.....
190c	3710	" " " Screw.....
17747	3719	" " " Thread Guard Pin....
63814	—	" " Body.....
63815	3719	Shuttle Race complete, Nos. 17746, 63814 and two 190c.....
158E	3724	Shuttle Race Screw.....
17853	3720	Starting Lever.....
1262c	3726	" " Hinge Screw.....
1662c	3726	" " " " Nut.....
17886	3716	" " Pitman.....
17854	3721	Stop Cam.....
17855	3721	" " Interlocking Rod.....
63977	7236	" " " " Case.....
63978	—	" " " " " 63977 with 18443 and two 193J.....

PARTS FOR MACHINE No. 68-1 19

NO.	PLATE	NAME
63993	—	Stop Cam Interlocking Rod Case 63978 with 63976 and two 1255J.....
*39405	—	Stop Cam Interlocking Rod Case 63993 with 1318D, 17855, 17863, 17864 and 39222.....
39346	3760	Stop Cam Interlocking Rod Case Bracket.....
63754	—	Stop Cam Interlocking Rod Case Bracket complete, Nos. 1182E, 1196c, 1204E, 1254c, 1262c, 1508E, 1662c, 17853, 17859, 17861, 17862, 17872, 17873, 39346, 39405 and two 898D.....
39347	—	Stop Cam Interlocking Rod Case Bracket 63754 with 39343, 39344 and two 1186J.....
16532	3722	Stop Cam Interlocking Rod Case Bracket Dowel Pin.....
1343E	3753	Stop Cam Interlocking Rod Case Bracket Screw.....
1204E	3721	Stop Cam Interlocking Rod Case Hinge Screw.....
17859	3720	Stop Cam Interlocking Rod Case Socket Joint.....
898D	3721	Stop Cam Interlocking Rod Case Socket Joint Cap Screw.....
39343	3760	Stop Cam Interlocking Rod Case Spring (flat).....
50682c	7235	Stop Cam Interlocking Rod Case Spring Adjusting Screw.....
1520E	3759	Stop Cam Interlocking Rod Case Spring Adjusting Screw Nut.....
39344	3759	Stop Cam Interlocking Rod Case Spring Bracket with 1520E and 50682c.....
1186J	3701	Stop Cam Interlocking Rod Case Spring Bracket Screw.....
17861	3721	Stop Cam Interlocking Rod Case Stop Stud.....
1254c	3726	" " " " " " " " Screw Bushing.....
1508E	3726	Stop Cam Interlocking Rod Case Stop Stud Screw Bushing Lock Nut.....
17862	3721	Stop Cam Interlocking Rod Case Stop Stud Spring.....
18443	3754	Stop Cam Interlocking Rod Case Wearing Block.....
193J	3754	Stop Cam Interlocking Rod Case Wearing Block Screw.....
17863	3721	Stop Cam Interlocking Rod Spring.....
17864	3721	" " " " Stop.....
1318D	3748	" " " " " Screw..

From the library of: Diamond Needle Corp

NO.	PLATE	NAME
3012	3722	Stop Cam Pin.....
1206c	3721	" " Screw.....
2102	3722	Tension Disc.....
1560c	3722	" Regulating Thumb Nut.....
600c	3722	" Screw Stud.....
16202	—	" " " 600c with 1560c.....
448c	3722	" " " Set Screw.....
2103	3722	" Spring.....
2105	3722	" Thread Guard.....
56791	—	Tension complete, Nos. 2103, 2124, 16202 and two 2102.....
*63749	—	Thread Take-up Cam.....
39204	3711	" " " 63749 with 446c...
3012	3722	" " " Pin.....
446c	3724	" " " Set Screw.....
*3072	3711	" " Lever with 1819.....
56855	—	" " " 3072 with 1088c...
1088c	7213	" " " Hinge Screw.....
1819	3724	" " " Roller and Stud..
2124	3722	" " Spring.....
2127	3722	" " " Regulator Plate
233j	3722	" " " " " "
		Adjusting Screw.....
17865	3710	Thread Wiper Body.....
1207d	3710	" " " Hinge Screw.....
17866	3710	" " " Hook.....
17867	3710	" " " Support.....
641c	3726	" " " " Set Screw...
17868	3710	" " " Wire.....
337j	3718	" " " " Screw.....
17869	3710	" " " " Washer..
63997	—	Throat Plate Body.....
39292	3756	" " 63997 with 17749, 17871 and two each 1208d and 50406d, for flat buttons.....
39293	—	Throat Plate 63997 with 17749, 17924 and two each 1208d and 50406d, for round bottom buttons.....
39406	—	Throat Plate 39292 with 1698E, 39270, 39291, 39488 and 50018r.....
39475	—	Throat Plate 39293 with 1698E, 39270, 39291, 39488 and 50018r.....
17749	3723	Throat Plate Extension.....
50406d	7213	" " " Screw.....
17871	3723	" " Needle Hole Bushing for 39292.....

NO.	PLATE	NAME
17924	3723	Throat Plate Needle Hole Bushing for 39293.....
1208d	3723	Throat Plate Needle Hole Bushing Screw
691f	3724	" " Screw.....
17872	3721	Trip Lever.....
1196c	3721	" " Hinge Screw.....
17873	3721	" " Spring.....
1182E	3705	" " " Screw.....
17874	3717	Tripping Point.....
190j	3710	" " Screw.....
*15404	—	Trade Mark.....
15405	20333	" " Rivet.....

MACHINE No. 68-4

FOR TROUSERS. BAR BUTTONS ONLY. MAKES EIGHTEEN STITCHES COVERING THE BAR AND THREE TYING STITCHES.

This Machine is the same as No. 68-1 with the following exception:

NO.	PLATE	NAME
17754	—	Feed Cam with two each 1192c, 17874 and four 190j, in place of 17751.....

Genuine "SINGER" Needles should be used in "SINGER" Machines. These Needles and their Containers are marked with the Company's Trade Mark "SIMANCO" 1

Needles in Containers marked "FOR SINGER MACHINES" are NOT "SINGER" made needles. 2

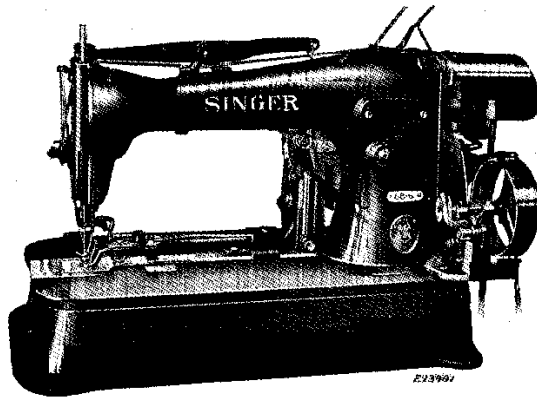

MACHINE No. 68-6

FOR CLOTHING, SHIRTWAISTS, ETC. MAKES CROSSED STITCHES IN FOUR-HOLE BUTTONS AND CAN BE ADJUSTED FOR TWO-HOLE AND BAR BUTTONS. MAKES EIGHTEEN CROSS AND THREE TYING STITCHES.

This Machine is the same as No. 68-1 with the following exception:

NO.	PLATE	NAME
17756	3712	Feed Cam with two each 1192c, 17874 and four 190j, in place of 17751.....

MACHINE No. 68-7

FOR SHIRTS, WAISTS AND UNDERWEAR. FOR FOUR-HOLE BUTTONS AND CAN BE ADJUSTED FOR TWO-HOLE AND BAR BUTTONS. SMALL BUTTONS ONLY. MAKES ELEVEN CROSS AND THREE TYING STITCHES.

This Machine is the same as No. 68-1 with the following exception:

NO.	PLATE	NAME
17757	—	Feed Cam with two 1192c, three 17874 and six 190j, in place of 17751.....

MACHINE No. 68-9

FOR SEWING STRAPS TO GARMENTS, UNDERWEAR, ETC. MAKES BAR $\frac{3}{8}$ TO $\frac{7}{8}$ INCH LONG, CONSISTING OF SEVEN STAYING, THIRTY-TWO COVERING AND THREE TYING STITCHES.

This Machine is the same as No. 68-1 with the following exceptions:

NO.	PLATE	NAME
17957	3731	Arch Clamp Foot with 17959.....
39206	3731	" " " Lifter with 17866, in place of 17708.....
190j	3710	Arch Clamp Foot Lifter Screw.....
17959	3731	" " " Lifting Stud.....
17960	3731	" " " Plate.....
217j	3731	" " " " Screw.....
39303	3731	" " " Spring.....
217j	3731	" " " " Screw (lower)...
1175j	3704	" " " " " (upper)...
39250	3742	" " Frame.....
14079	3731	" " " Dowel Pin.....
181j	3738	" " " Screw.....
39251	—	Arch Clamp complete, Nos. 1175j, 1654c, 17957, 17960, 17963, 39250, 39253, 39303, two each 181j, 1186c, 1651j, 14079, 17803 and five 217j, in place of 17898.....
17759	—	Feed Cam with 17874 and two each 190j and 1192c, in place of 17751.....
17963	3731	Feed Plate, in place of 17800 and 17923..
*39252	3743	" " Carrier Bar, in place of 39259
39253	—	" " " " 39252 with 934j, 1195e, 8505, 17743, 17802, 17804, 18368, two 7476 and four 17806, in place of 39260.....
39294	—	Throat Plate 63997 with 17749, 39213 and two each 1208d and 50406d, in place of 39292 or 39293.....
39474	—	Throat Plate 39294 with 1698e, 39270, 39291, 39488 and 50018f, in place of 39406.....
39213	3731	Throat Plate Needle Hole Bushing, in place of 17871 and 17924.....

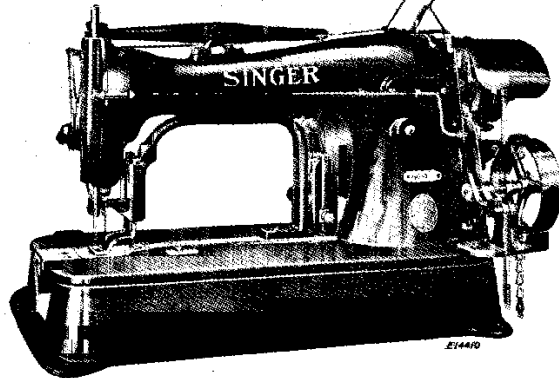

MACHINE No. 68-10

FOR BARRING POCKETS ON CLOTHING. MAKES BAR $\frac{5}{16}$ TO $\frac{5}{8}$ INCH LONG. CONSISTING OF TWELVE STAYING, TWENTY-SEVEN COVERING AND THREE TYING STITCHES.

This Machine is the same as No. 68-1 with the following exceptions:

NO.	PLATE	NAME
17964	3733	Arch Clamp Foot (left) with 17959.....
17965	3733	" " " (right) with 17959.....
17958	3733	" " " Lifter with 17866, in place of 17708.....
190J	3710	Arch Clamp Foot Lifter Screw.....
17959	3731	" " " Lifting Stud.....
17966	3733	" " " Plate.....
217J	3731	" " " Screw.....
39302	3731	" " " Spring.....
17967	3733	" " " Connection.....
1175J	3704	" " " " Hinge Screw.....
217J	3731	Arch Clamp Foot Spring Screw.....
17968	3732	" " " Frame.....
14079	3731	" " " Dowel Pin.....
1177J	3710	" " " Screw.....

19789

NO.	PLATE	NAME
17969	—	Arch Clamp complete, Nos. 1654c, 17964 to 17968, 17970, 39254, 39802, two each 1175J, 1177J, 1186c, 1651J, 14079, 17803 and five 217J, in place of 17898.....
*63990	—	Arm with 4449, 15404, 17844 and two each 164E and 15405, in place of 63989.....
17760	—	Feed Cam with 17874 and two each 190J and 1192c, in place of 17751.....
17970	3740	Feed Plate, in place of 17800 and 17923..
*17971	3736	" " " Carrier Bar, in place of 39259
39254	—	" " " " 17971 with 934J, 1195E, 8505, 17743, 17802, 17804, 18368, two 7476 and four 17806, in place of 39260.....
39283	3754	Hand Stop Lever.....
86D	3754	" " " Hinge Screw.....
39284	3741	" " " Rod.....
21678	3754	" " " " Collar with 1019c..
1019c	3754	" " " " " Set Screw..
39285	3754	" " " " Connection.....
93F	3754	" " " " " Screw..
39286	3754	" " " " Guide Stud (back)
39287	3754	" " " " " (front)
1565D	3754	" " " " Head.....
24122	3754	" " " " Spring.....
39348	3760	Stop Cam Interlocking Rod Case Bracket, in place of 39346.....
63752	—	Stop Cam Interlocking Rod Case Bracket complete, Nos. 1182E, 1196c, 1204E, 1254c, 1262c, 1508E, 1662c, 17853, 17859, 17861, 17862, 17872, 17873, 39348, 39405 and two 898D, in place of 63754.....
39349	—	Stop Cam Interlocking Rod Case Bracket 63752 with 39343, 39344 and two 1186J, in place of 39347.....

Genuine "SINGER" Needles should be used in "SINGER" Machines. These Needles and their Containers are marked with the Company's Trade Mark "SIMANCO" 1

Needles in Containers marked "FOR SINGER MACHINES" are NOT "SINGER" made needles. 2

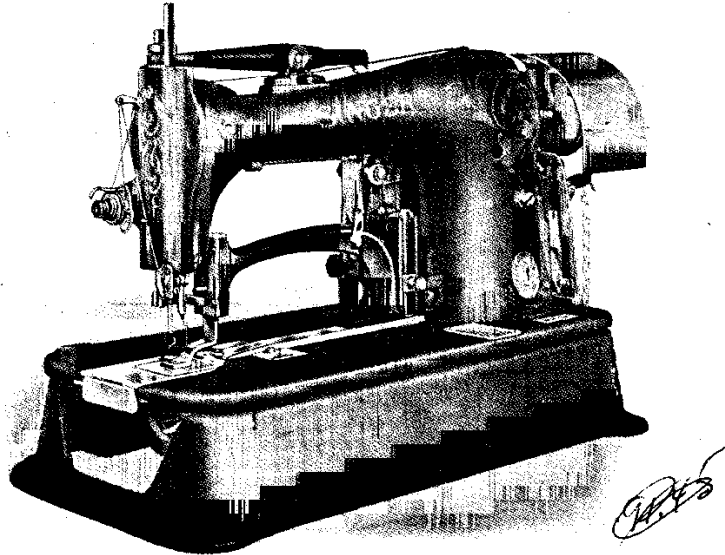

MACHINE No. 68-11

FOR BARRING BUTTONHOLES IN FINE WORK AND FOR FASTENING BOWS OR OTHER ORNAMENTS TO SHOES OR GARMENTS. MAKES BAR 1/8 TO 1/4 INCH LONG, CONSISTING OF SEVEN STAYING, ELEVEN COVERING AND THREE TYING STITCHES.

This Machine is the same as No. 68-1 with the following exceptions:

NO.	PLATE	NAME
17972	3735	Arch Clamp Foot with 17959.....
39215	3745	" " " " 17959, 39216, 39217 and two 233J.....
17708	3710	Arch Clamp Foot Lifter with 17866.....
17959	3731	" " " Lifting Stud.....
17960	3731	" " " Plate.....
217J	3731	" " " Screw.....
39303	3731	" " " Spring.....
217J	3731	" " " Screw (lower)....
1175J	3704	" " " " (upper)....
39216	3745	" " " Yielding Presser Spring (back) for 39215.....

PARTS FOR MACHINE No. 68-11 27

86.25 x
91.45

NO.	PLATE	NAME
39217	3745	Arch Clamp Foot Yielding Presser Spring (front) for 39215.....
233J	3722	Arch Clamp Foot Yielding Presser Spring Screw.....
39255	3742	Arch Clamp Frame.....
14079	3731	" " " Dowel Pin.....
181J	3738	" " " Screw.....
39256	—	Arch Clamp complete, Nos. 1175J, 1654C, 17960, 17972, 17975, 39253, 39255, 39303, two each 181J, 1186C, 1651J, 14079, 17803 and five 217J, in place of 17898.....
17761	—	Feed Cam with two each 1192C, 17874 and four 190J, in place of 17751.....
17975	3735	Feed Plate, in place of 17800 and 17923..
*39252	3743	" " Carrier Bar, in place of 39259
39253	—	" " " " 39252 with 934J, 1195E, 8505, 17743, 17802, 17804, 18368, two 7476 and four 17806, in place of 39260.....

MACHINE No. 68-12

DIFFERS FROM No. 68-11 ONLY IN HAVING THE CLAMP FITTED FOR CLOSING TOGETHER THE END OF THE BUTTON-HOLE BEFORE BARRING.

This Machine is the same as No. 68-1 with the following exceptions:

NO.	PLATE	NAME
17976	3737	Clamp Arm (lower) left.....
17977	3737	" " " right.....
17978	3737	" " " Bracket.....
63781	—	" " " " 17978 with 14008 and 17981.....
181J	3738	Clamp Arm (lower) Bracket Screw.....
7401	3738	" " " " Steady Pin..
90J	3738	" " " Hinge Screw.....
17979	3738	" " (upper) left, with 17986 and 39257.....
17980	3738	Clamp Arm (upper) right, with 17986 and 39257.....
17981	3737	Clamp Arm (upper) Bracket.....
14008	3737	" " " " Hinge Pin...
90J	3738	" " " Hinge Screw.....

From the library of: Diamond Needle Corp

NO.	PLATE	NAME
39257	3745	Clamp Arm (upper) Hook, in place of 17711
17708	3710	" " " Lifter, with 17866
17982	3738	" " " Pressure Spring, in place of 17712
17713	3710	" " " Bracket
1177j	3710	" " " " Screw
1178j	3710	" " " " Screw
20437	20333	" " " " Washer
17983	3737	" " " Spreader Lever
957k	3738	" " " Cap Screw
17984	3738	" " " Friction Washer
17985	3738	" " " Hinge Stud
17986	3738	" " " Stud
17987	—	Clamp complete, Nos. 181j, 957k, 1177j, 1178j, 17713, 17802, 17804, 17976, 17977, 17979, 17980, 17982 to 17984, 17988, 17989, 20437, 39301, 63781, two each 1186c, 1651j, 7401, 7476, 17803 and four each 90j and 17806, in place of 17898
17761	—	Feed Cam with two each 1192c, 17874 and four 190j, in place of 17751
17988	3737	Feed Plate (left)
17989	3737	" " (right)
17806	3701	" " Rivet
*17990	3736	" " Carrier Bar, in place of 39259
39301	—	" " " " 17990 with 934j, 17743, 17985 and 18368, in place of 39260

MACHINE No. 68-14

FOR SHOE TACKING. MAKES TWO STAY, NINE LONG, SEVEN CROSS AND THREE TYING STITCHES

This Machine is the same as No. 68-1 with the following exceptions:

NO.	PLATE	NAME
63811	7205	Clamp Arm (lower) with two 17992
17992	3740	" " " Hook, in place of 17711
63812	7205	" " (upper)
39333	3761	" " Bracket
39336	3761	Clamp Arm Bracket (adjustable) complete, Nos. 129j, 1178j, 1300j, 1654c, 39333 to 39335 and 50048j, in place of 17713
129j	3761	Clamp Arm Bracket Adjusting Screw
39334	3761	" " " Hinge Block

NO.	PLATE	NAME
1300j	3761	Clamp Arm Bracket Hinge Block Screw in place of 1177j
50048j	3761	Clamp Arm Bracket Hinge Screw (eccentric)
1654c	3761	" " " " " Nut
17958	3733	" " " Lifter with 17866, in place of 17708
190j	3710	Clamp Arm Lifter Screw
17720	3705	" " Pin
1178j	3710	" " Screw
39335	3761	" " " Plate
39337	—	Clamp complete, Nos. 1654c, 17720, 39260, 39304, 39336, 63811, 63812 and two each 1186c, 1651j and 17803, in place of 17898
17764	—	Feed Cam with 17874 and two each 190j and 1192c, in place of 17751
39231	3746	Feed Cam Driving Worm with 1441c and 1442c, in place of 18415
17997	3725	Feed Cam Driving Worm Wheel with 453c, in place of 17797
39304	3744	Feed Plate, in place of 17800 and 17923

MACHINE No. 68-15

FOR TACKING ORNAMENTS TO SHOES. MAKES ELEVEN CROSS AND THREE TYING STITCHES

This Machine is the same as No. 68-1 with the following exceptions:

NO.	PLATE	NAME
17999	3739	Clamp Arm with two 39257
39333	3761	" " Bracket
39336	3761	Clamp Arm Bracket (adjustable) complete, Nos. 129j, 1178j, 1300j, 1654c, 39333 to 39335 and 50048j, in place of 17713
129j	3761	Clamp Arm Bracket Adjusting Screw
39334	3761	" " " Hinge Block
1300j	3761	" " " " " Screw, in place of 1177j
50048j	3761	Clamp Arm Bracket Hinge Screw (eccentric)
1654c	3761	" " " " " Nut
39257	3745	" " Hook, in place of 17711
17958	3733	" " Lifter with 17866, in place of 17708

NO.	PLATE	NAME
190J	3710	Clamp Arm Lifter Screw.....
1178J	3710	“ “ Screw.....
39335	3761	“ “ Plate.....
39338	—	Clamp complete, Nos. 1654c, 17999, 39258, 39260, 39336 and two each 1186c, 1651J and 17803, in place of 17898.....
17765	—	Feed Cam with two 1192c, three 17874 and six 190J, in place of 17751.....
39258	3745	Feed Plate (thin) in place of 17800.....
39362	—	“ “ (thick) in place of 17923.....

MACHINE No. 68-16

FOR SHOE TACKING. MAKES TACK UP TO 3/8 INCH LONG. TWO STAY, NINE LONG AND SEVEN CROSS STITCHES

This Machine is the same as No. 68-1 with the following exceptions:

NO.	PLATE	NAME
63811	7205	Clamp Arm (lower) with two 17992.....
17992	3740	“ “ Hook, in place of 17711
63812	7205	“ “ (upper).....
39333	3761	“ “ Bracket.....
39336	3761	Clamp Arm Bracket (adjustable) complete, Nos. 129J, 1178J, 1300J, 1654c, 39333 to 39335 and 50048J, in place of 17713.....
129J	3761	Clamp Arm Bracket Adjusting Screw.....
39334	3761	“ “ Hinge Block.....
1300J	3761	“ “ Screw, in place of 1177J.....
50048J	3761	Clamp Arm Bracket Hinge Screw (eccentric)
1654c	3761	“ “ Nut.....
17958	3733	“ “ Lifter with 17866, in place of 17708.....
190J	3710	Clamp Arm Lifter Screw.....
17720	3705	“ “ Pin.....
1178J	3710	“ “ Screw.....
39335	3761	“ “ Plate.....
39337	—	Clamp complete, Nos. 1654c, 17720, 39260, 39304, 39336, 63811, 63812 and two each 1186c, 1651J and 17803, in place of 17898.....
17766	—	Feed Cam with two each 1192c, 17874 and four 190J, in place of 17751.....

NO.	PLATE	NAME
39211	3746	Feed Cam Driving Worm with 1441c and 1442c, in place of 18415.....
39212	3743	Feed Cam Driving Worm Wheel with 453c, in place of 17797.....
39304	3744	Feed Plate, in place of 17800 and 17923..

MACHINE No. 68-17

MAKES CROSS STITCHES IN CLOTH OR LEATHER. FOR ORNAMMENTING GARMENTS, LADIES' BELTS, SADDLES, APRONS, ETC.

This Machine is the same as No. 68-1 with the following exceptions:

NO.	PLATE	NAME
39225	3744	Clamp with 17948, in place of 17706 and 17707.....
17947	3729	Clamp Arm with 17714 and 63788, in place of 17901.....
17708	3710	Clamp Arm Lifter with 17866.....
63788	7205	“ “ Hook.....
17948	3729	“ Hinge Stud, in place of 1175J....
17949	3729	“ “ Pin.....
1263J	3729	“ Leveling Thumb Screw.....
17950	3729	“ “ Stop Bracket
220J	3729	“ “ “ “ “ “ Screw.....
17712	3710	Clamp Pressure Spring.....
17713	3710	“ “ Bracket.....
1177J	3710	“ “ Screw....
17714	3704	“ “ Guide Block.....
1178J	3710	“ “ Screw.....
20437	20333	“ “ Washer....
17951	3729	“ Stretching Ring.....
1264J	3729	“ “ Hinge Screw.....
17952	3729	“ “ Spring.....
220J	3729	“ “ Adjusting Screw.....
578K	3729	Clamp Stretching Ring Spring Screw....
39226	—	Clamp complete, Nos. 578K, 1263J, 17947, 17949 to 17952, 39225, two 1264J and three 220J, in place of 17898.....
17767	—	Feed Cam with two each 1192c, 17874 and four 190J, in place of 17751.....
39227	3744	Feed Plate, in place of 17800 and 17923..

From the library of: Diamond Needle Corp

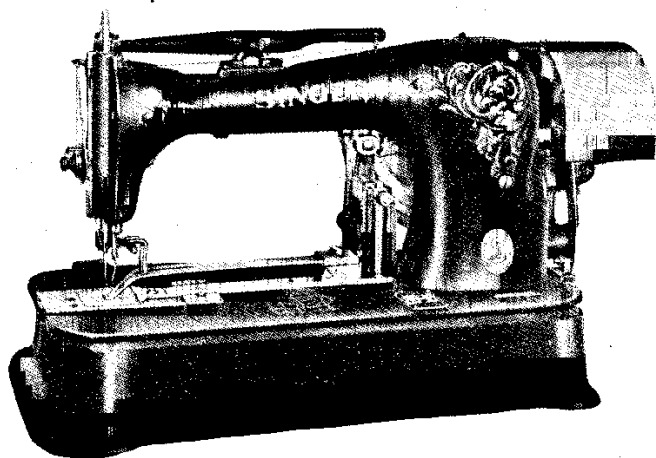

MACHINE No. 68-18

FOR TACKING COST MARKS ON CLOTHING. MAKES FOUR CROSS AND THREE TYING STITCHES.

This Machine is the same as No. 68-1 with the following exceptions:

NO.	PLATE	NAME
17999	3739	Clamp Arm with two 39257.....
39333	3761	" " Bracket.....
39336	3761	Clamp Arm Bracket (adjustable) complete, Nos. 129J, 1178J, 1300J, 1654c, 39333 to 39335 and 50048J, in place of 17713.....
129J	3761	Clamp Arm Bracket Adjusting Screw.....
39334	3761	" " " " Hinge Block.....
1300J	3761	" " " " " " Screw, in place of 1177J.....
50048J	3761	Clamp Arm Bracket Hinge Screw (eccentric).....
1654c	3761	Clamp Arm Bracket Hinge Screw Nut....
39257	3745	" " Hook, in place of 17711.....
17958	3733	" " Lifter with 17866, in place of 17708.....

PARTS FOR MACHINE No. 68-18 33

NO.	PLATE	NAME
190J	3710	Clamp Arm Lifter Screw.....
1178J	3710	" " " Screw.....
39335	3761	" " " Plate.....
39338	—	Clamp complete, Nos. 1654c, 17999, 39258, 39260, 39336 and two each 1186c, 1651J and 17803, in place of 17898.....
17768	—	Feed Cam with two 1192c, and six each 190J and 17874, in place of 17751.....
39258	3745	Feed Plate (thin) in place of 17800.....
39362	—	" " (thick) in place of 17923.....

MACHINE No. 68-19

FOR ATTACHING SAFETY PIN TUBES AND TRUSS BUCKLES TO UNDERGARMENTS, VESTS, OVERALLS, ETC. MAKES THIRTY-NINE COVERING AND THREE TYING STITCHES, COVERING $\frac{3}{8}$ TO $\frac{3}{4}$ IN. IN LENGTH.

This Machine is the same as No. 68-1 with the following exceptions:

NO.	PLATE	NAME
39314	3757	Clamp (left) with 17723, 39316 and two 9558, in place of 17706.....
39315	3757	Clamp (right) with 17723, 39317 and two 9558, in place of 17707.....
17901	3704	Clamp Arm with 17711, 17714 and 23227
17710	3704	" " " " Hinge Plate.....
1176J	3704	" " " " " " Screw.....
17711	3704	" " " " Hook.....
39316	3757	" " " " Buckle Stop (left).....
39317	3757	" " " " (right).....
9558	3757	" " " " Rivet.....
1175J	3704	" " " " Hinge Screw.....
17958	3733	" " " " Lifter with 17866, in place of 17708
190J	3710	" " " " " " Screw.....
17712	3710	" " " " Pressure Spring.....
17713	3710	" " " " " " Bracket.....
1177D	3710	" " " " " " " " Screw.....
17714	3704	" " " " " " Guide Block.....
1178J	3710	" " " " " " " " Screw.....
20437	20333	" " " " " " " " Washer.....
17716	3705	" " " " " " Spreader.....
39318	3757	" " " " " " Holder with two 17720, in place of 17722.....

NO.	PLATE	NAME
1183j	3705	Clamp Spreader Holder Screw.....
17717	3705	" " Lever.....
50237k	3705	" " Hinge Screw.....
1180j	3705	" " Locking Thumb Screw.....
17718	3705	Clamp Spreader Lever Locking Thumb Screw Washer.....
1182j	3705	Clamp Spreader Screw.....
17719	3705	" " Spring.....
1181j	3705	" " " Screw.....
17720	3705	" " Steady Pin.....
17723	3704	" Stud.....
39319	—	Clamp complete, for truss buckles, Nos. 1180j, 1181j, 1182j, 1183j, 17716 to 17719, 17901, 39314, 39315, 39318, 50237k and two 1175j, in place of 17898
39320	3785	Clamp with 1220E and 17928, in place of 17899.....
17927	3706	Clamp Arm with 17714 and 63788, in place of 17901.....
63788	7205	Clamp Arm Hook.....
17928	3706	" Position Stud.....
17712	3710	" Pressure Spring.....
17714	3704	" " Guide Block.....
1220E	3706	" Screw Stud.....
39321	3785	" Spring, in place of 17902.....
1208j	3723	" " Screw, in place of 236j.....
1656j	8706	" Thumb Nut.....
39322	—	Clamp complete, for safety pin tubes, Nos. 39320, 39321 and two 1208j.....
39323	—	Clamp with Arm complete, Nos. 1656j, 17927 and 39322, in place of 17904.....
17769	—	Feed Cam with 17874 and two each 190j and 1192c, in place of 17751.....
17970	3740	Feed Plate, in place of 17800 and 17923..

Genuine "SINGER" Needles should be used
in "SINGER" Machines.
These Needles and their Containers
are marked with the
Company's Trade Mark "SIMANCO" 1

Needles in Containers marked
"FOR SINGER MACHINES"
are NOT "SINGER" made needles. 2

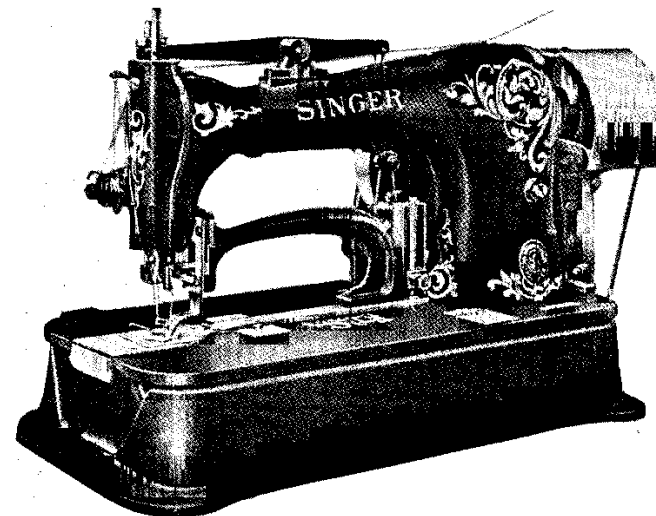

MACHINE No. 68-20

FOR MAKING FERN LEAF SHAPED ORNAMENTS ON FINE
UNDERWEAR, MILLINERY GOODS, ETC. MAKES FORTY-
TWO STITCHES

This Machine is the same as No. 68-1
with the following exceptions:

NO.	PLATE	NAME
63724	7206	Arch Clamp Foot (left) with 63726, in place of 17706.....
63725	7206	Arch Clamp Foot (right) with 63726, in place of 17707.....
17958	3733	Arch Clamp Foot Lifter with 17866, in place of 17708.....
190j	3710	Arch Clamp Foot Lifter Screw.....
63726	7206	" " " Lifting Stud.....
18433	3762	" " " Plate.....
217j	3731	" " " " Screw.....

From the library of: Diamond Needle Corp

NO.	PLATE	NAME
39302	3731	Arch Clamp Foot Spring.....
18434	3762	" " " " Connection.....
1175j	3704	" " " " " Hinge Screw.....
217j	3731	Arch Clamp Foot Spring Screw.....
63727	7207	" " Frame.....
14079	3731	" " " Dowel Pin.....
181j	3738	" " " Screw.....
63728	—	Arch Clamp complete, Nos. 1654c, 18433, 18434, 39253, 39302, 39311, 63724, 63725, 63727, two each 181j, 1175j, 1186c, 1651j, 14079, 17803 and five 217j, in place of 17898.....
*63805	—	Bed, in place of 17704.....
39309	3758	Feed Across Lever Bracket with 39310 and three 160j, in place of 17731.....
*39310	—	Feed Across Lever Bracket Cap, in place of 17732.....
17770	—	Feed Cam with 17874 and two each 190j and 1192c, in place of 17751.....
39311	3762	Feed Plate, in place of 17800 and 17923..
*39252	3743	" " " Carrier Bar, in place of 39259.
39253	—	" " " " 39252 with 934j, 1195e, 8505, 17743, 17802, 17804, 18368, two 7476 and four 17806, in place of 39260.....
39312	3758	Feed Regulator with 1953, in place of 17742.....
39313	3759	Feed Regulator Swivel, in place of 17745.
39294	—	Throat Plate 63997 with 17749, 39213 and two each 1208b and 50406b, in place of 39292 and 39293.....
39474	—	Throat Plate 39294 with 1698e, 39270, 39291, 39488 and 50018r, in place of 39406.....
39213	3731	Throat Plate Needle Hole Bushing, in place of 17871 and 17924.....

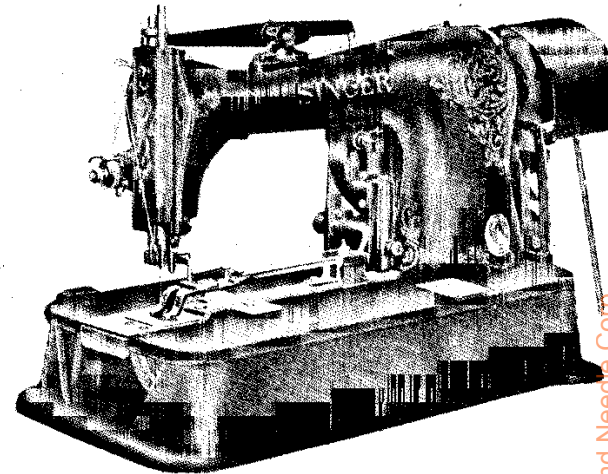

MACHINE No. 68-21

FOR STITCHING LARGE BUTTONS UPON COATS, CLOAKS,
OVERCOATS, ETC. MAKES CROSSED STITCHES IN FOUR-
HOLE BUTTONS AND CAN BE ADJUSTED FOR TWO-HOLE
AND BAR BUTTONS. NEEDLE THROW $\frac{3}{8}$ IN. TO $\frac{1}{2}$ INCH.
MAKES EIGHTEEN CROSS AND THREE TYING STITCHES.

This Machine is the same as No. 68-1
with the following exceptions:

NO.	PLATE	NAME
18464	3764	Button Clamp (left) with 9311 and 17723, in place of 17706.....
18465	3764	Button Clamp (right) with 9311 and 17723, in place of 17707.....
18466	3764	Button Clamp Stop with two 17720, in place of 17722.....
63929	—	Button Clamp (universal) complete, for 26 to 55 line buttons, Nos. 1180j, 1181j, 1182j, 1183j, 17717 to 17719, 18464 to 18466, 39242, 39244 or 39246, 39245 or 39247, 50237k, 63927 and two each 229j and 1175j, in place of 17898 and 63928.....

NO.	PLATE	NAME
39309	3758	Feed Across Lever Bracket with 39310 and three 160r, in place of 17731.....
*39310	—	Feed Across Lever Bracket Cap, in place of 17732.....
17771	—	Feed Cam with 17874 and two each 190j and 1192c, in place of 17751.....
39231	3746	Feed Cam Driving Worm with 1441c and 1442c, in place of 18415.....
17997	3725	Feed Cam Driving Worm Wheel with 453c, in place of 17797.....
18468	3764	Feed Plate, in place of 17800 and 17923..
39312	3758	" Regulator with 1953 in place of 17742.....
39313	3759	Feed Regulator Swivel, in place of 17745..
39324	3752	Thread Take-up Cam with 446c, in place of 39204.....
*18393	3752	Thread Take-up Lever with 1822, in place of 3072.....
55283	—	Thread Take-up Lever 18393 with 79c...
79c	3753	" " " Hinge Screw, in place of 1088c.....
1822	3753	Thread Take-up Lever Roller and Stud, in place of 1819.....
63786	—	Throat Plate 63997 with 17749, 39486 and two each 1208D and 50406D, in place of 39292.....
63787	—	Throat Plate 63786 with 1698E, 39270, 39291, 39488 and 50018F, in place of 39406.....
39486	7214	Throat Plate Needle Hole Bushing, in place of 17871.....
63718	—	Throat Plate Needle Hole Bushing, in place of 17924.....

Genuine "SINGER" Needles should be used in "SINGER" Machines. These Needles and their Containers are marked with the Company's Trade Mark "SIMANCO" 1

Needles in Containers marked "FOR SINGER MACHINES" are NOT "SINGER" made needles. 2

MACHINE No. 68-22

FOR FASTENING TONGUE BUCKLES 3/8 TO 3/4 INCH WIDE UPON SHOES OR OTHER ARTICLES BY OVERSTITCHING THE BAR OF THE BUCKLE ON BOTH SIDES OF THE TONGUE. MAKES FORTY-TWO STITCHES, INCLUDING TYING STITCHES.

This Machine is the same as No. 68-1 with the following exceptions:

NO.	PLATE	NAME
39371	3764	Buckle Clamp with 1220E and 17928, for 39372, in place of 17899 and 17900.....
39363	3765	Buckle Clamp (left) with 9311 and 17723, for 63971, in place of 17706.....
39364	3765	Buckle Clamp (right) with 9311 and 17723, for 63971, in place of 17707.....
63970	7237	Buckle Clamp Arm with 17714 and 63788, for 63971, in place of 17901.....
17927	3706	Buckle Clamp Arm with 17714 and 63788, for 39372, in place of 17901.....
17710	3704	Buckle Clamp Arm Hinge Plate.....
1176J	3704	" " " " " Screw....
63788	7205	" " " Hook.....
39366	3766	" " Buckle Stop, in place of 17722.....
1180J	3705	Buckle Clamp Buckle Stop Thumb Screw
17718	3705	" " " " " " Washer.....
1175J	3704	Buckle Clamp Hinge Screw.....
17958	3733	" " Lifter with 17866, in place of 17708.....
190J	3710	Buckle Clamp Lifter Screw.....
17928	3706	" " Position Stud.....
39241	3748	" " Pressure Spring for 63971, in place of 17712.....
17712	3710	Buckle Clamp Pressure Spring for 39372..
17713	3710	" " " " Bracket...
1177J	3710	" " " " " Screw
17714	3704	" " " " " Guide Block.....
1178J	3710	Buckle Clamp Pressure Spring Screw
20437	20333	" " " " " " Washer.....
1220E	3706	Buckle Clamp Screw Stud.....
1656J	3706	" " " " " Thumb Nut...

From the library of: Diamond Needle Corp

NO.	PLATE	NAME
39242	3748	Buckle Clamp Spreader, in place of 17716
39367	3764	" " " Holder with two 17720.....
1183j	3705	Buckle Clamp Spreader Holder Screw....
17717	3705	" " " Lever.....
50237k	3705	" " " " Hinge Screw
1180j	3705	" " " " Locking Thumb Screw.....
17718	3705	Buckle Clamp Spreader Lever Locking Thumb Screw Washer.....
1182j	3705	Buckle Clamp Spreader Screw.....
17719	3705	" " " Spring.....
1181j	3705	" " " " Screw Stud
17720	3705	" " " Steady Pin.....
39368	3765	" " Spring (left) in place of 17721.....
39369	3765	Buckle Clamp Spring (right) in place of 17721.....
229j	3702	Buckle Clamp Spring Screw, in place of 236j.....
9311	3747	Buckle Clamp Spring Steady Pin.....
17723	3704	" " Stud.....
63971	—	" " (adjustable) complete, for buckles without tongue, Nos. 1181j, 1182j, 1183j, 17717, 17719, 39242, 39363, 39364, 39366 to 39369, 50237k, 63970 and two each 229j, 1175j, 1180j and 17718, in place of 17898.....
39372	—	Buckle Clamp complete, for buckles with tongue, Nos. 1656j, 17927 and 39371, in place of 17904.....
17772	—	Feed Cam with 17874 and two each 190j and 1192c, in place of 17751.....
39373	3766	Feed Plate (thick) in place of 17923.....
63930	7238	" " (thin) in place of 17800.....

Genuine "SINGER" Needles should be used
in "SINGER" Machines.
These Needles and their Containers
are marked with the
Company's Trade Mark "SIMANCO" 1

Needles in Containers marked
"FOR SINGER MACHINES"
are NOT "SINGER" made needles. 2

MACHINE No. 68-23

FOR TACKING COST MARKS OR OTHER TICKETS UPON CLOTH-
ING. MAKES TACKS $\frac{3}{8}$ TO $\frac{1}{2}$ INCH LONG, CONSISTING
OF NINE STITCHES IN TWO SECTIONS, INCLUDING TYING
STITCHES.

This Machine is the same as No. 68-1
with the following exceptions:

NO.	PLATE	NAME
39326	3739	Clamp Arm with two 39257, in place of 63927.....
39333	3761	Clamp Arm Bracket.....
39336	3761	Clamp Arm Bracket (adjustable) complete, Nos. 129j, 1178j, 1300j, 1654c, 39333 to 39335 and 50048j, in place of 17713..
129j	3761	Clamp Arm Bracket Adjusting Screw.....
39334	3761	" " " Hinge Block.....
1300j	3761	" " " " " Screw, in place of 1177j.....
50048j	3761	Clamp Arm Bracket Hinge Screw (eccen- tric).....
1654c	3761	Clamp Arm Bracket Hinge Screw Nut....
39257	3745	" " Hook, in place of 17711.....
17958	3733	" " Lifter with 17866, in place of 17708.....
190j	3710	Clamp Arm Lifter Screw.....
1178j	3710	" " Screw.....
39335	3761	" " " Plate.....
39339	—	Clamp complete, Nos. 1654c, 39260, 39326, 39328, 39336, and two each 1186c, 1651j and 17803, in place of 17898
17773	—	Feed Cam with two 1192c and four each 190j and 17874, in place of 17751.....
39211	3746	Feed Cam Driving Worm with 1441c and 1442c, in place of 18415.....
39212	3743	Feed Cam Driving Worm Wheel with 453c, in place of 17797.....
39328	3759	Feed Plate, in place of 17800 and 17923..

From the library of: Diamond Needle Corp

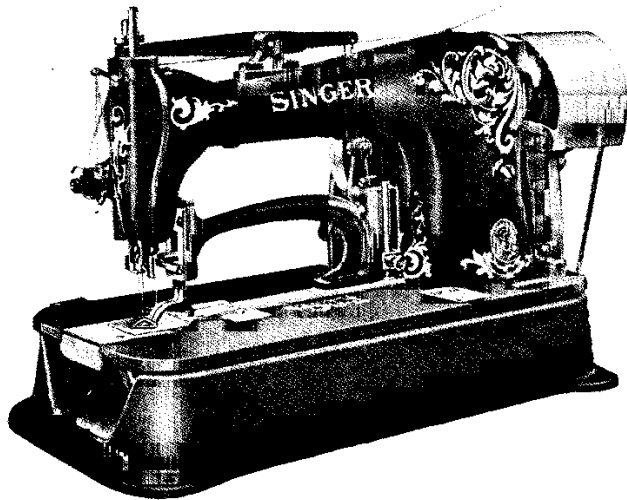

MACHINE No. 68-24

FOR TACKING AND ORNAMENTING FINE UNDERWEAR.
MAKES TRIANGULAR TACK OR ORNAMENT, CONSISTING
OF FORTY-TWO STITCHES.

This Machine is the same as No. 68-1
with the following exceptions:

NO.	PLATE	NAME
39353	3767	Arch Clamp Foot (left).....
63729	—	“ “ “ “ 39353 with 219κ and 63731, in place of 17706.....
39355	3767	Arch Clamp Foot (right).....
63730	—	“ “ “ “ 39355 with 219κ and 63732, in place of 17707.....
17958	3733	Arch Clamp Foot Lifter with 17866, in place of 17708.....

PARTS FOR MACHINE No. 68-24 43

NO.	PLATE	NAME
190j	3710	Arch Clamp Foot Lifter Screw.....
63726	7206	“ “ “ Lifting Stud.....
18477	3767	“ “ “ Plate.....
190j	3710	“ “ “ “ Screw.....
219κ	3767	“ “ “ Screw.....
63731	7206	“ “ “ Shank (left) with 63726
63732	7206	“ “ “ “ (right) with 63726.....
18480	3739	Arch Clamp Foot Spring (heavy).....
63733	7207	“ “ “ “ (light).....
1229f	3767	“ “ “ “ Adjusting Screw
1547j	3767	“ “ “ “ “ “
		Lock Nut.....
63734	7207	Arch Clamp Frame.....
14079	3731	“ “ “ Dowel Pin.....
181j	3738	“ “ “ Screw.....
63735	—	Arch Clamp complete, Nos. 1654c, 18477, 39358, 39360, 63729, 63730, 63734, two each 181j, 1186c, 1229f, 1547j, 1651j, 14079, 17803, 63733 and four 190j, in place of 17898.....
*63805	—	Bed, in place of 17704.....
39309	3758	Feed Across Lever Bracket with 39310 and three 160j, in place of 17731.....
*39310	—	Feed Across Lever Bracket Cap, in place of 17732.....
17774	—	Feed Cam with 17874 and two each 190j and 1192c, in place of 17751.....
39358	3767	Feed Plate, in place of 17800 and 17923..
*39359	3739	“ “ Carrier Bar, in place of 39259
39360	—	“ “ “ “ 39359 with 810d, 934j, 1195e, 8505, 17802, 17804, 18368, 18488, 18489, two 7476 and four 17806, in place of 39260.....
39361	3758	Feed Regulator with 1953, in place of 17742.....
18488	3759	Feed Regulator Post, in place of 17743.
18489	3759	“ “ “ Guide, in place of 1190c.....
810d	3759	Feed Regulator Post Guide Cap Screw....
39313	3759	“ “ Swivel, in place of 17745..

From the library of: Diamond Needle Corp

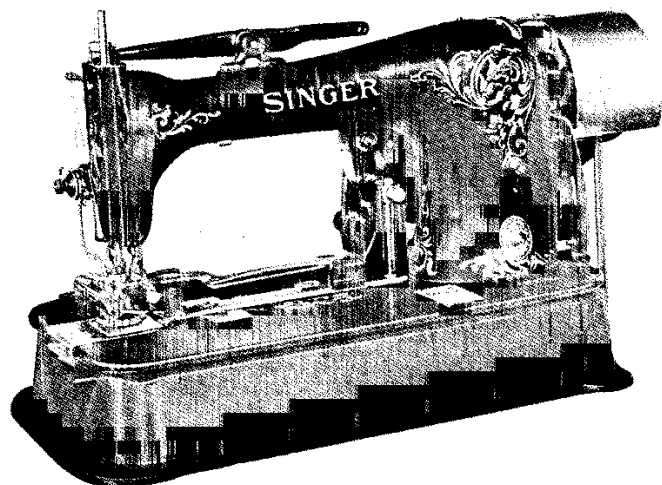

MACHINE No. 68-25

FOR STITCHING SELF-SHANK BUTTONS ON SHIRTS, SHIRT-WAISTS, ETC. MAKES ELEVEN CROSS AND THREE TYING STITCHES.

This Machine is the same as No. 68-1
with the following exceptions:

NO.	PLATE	NAME
39375	3769	Button Clamp (left) in place of 17706....
1175J	3769	" " " Hinge Screw.....
39376	3769	" " (right) in place of 17707....
1175J	3769	" " " Hinge Screw.....
39377	3768	" " Arm with 17711 and 17714, in place of 17901.....
39378	3769	Button Clamp Foot.....
207J	3769	" " " Screw.....
871J	3770	" " Lifting Screw Stud.....
39379	3770	" " Pressure Spring, in place of 17712

PARTS FOR MACHINE No. 68-25 45

NO.	PLATE	NAME
39380	3769	Button Clamp Spreader Link (left).....
105J	3769	" " " " " Hinge Screw for 39375.....
39381	3769	Button Clamp Spreader Link (right).....
105J	3769	" " " " " Hinge Screw for 39376.....
1175J	3769	Button Clamp Spreader Link Hinge Screw for 39392.....
1263J	3769	Button Clamp Spreader Thumb Screw....
39382	3769	" " " " " Block
39383	3769	" " Stop (front).....
39384	3769	" " " " Arm.....
39385	3769	" " " " Holder....
39386	3769	" " " " " Plate
1302J	3769	" " " " " " "
		Screw.....
176K	3769	Button Clamp Stop (front) Arm Screw...
39387	3769	" " " " Lever.....
105J	3769	" " " " " Hinge Screw.....
1180J	3769	Button Clamp Stop (front) Lever Thumb Screw.....
17718	3769	Button Clamp Stop (front) Lever Thumb Screw Washer.....
1607J	3769	Button Clamp Stop (front) Nut.....
17719	3769	" " " " Spring.....
233J	3769	" " " " " Screw.
714J	3769	" " " " " Thumb Screw.....
39388	3769	Button Clamp Stop (upper).....
39389	3770	" " " " " Lever.....
90J	3770	" " " " " Hinge Screw.....
5569	3770	Button Clamp Stop (upper) Lever Spring
233J	3769	" " " " " " " Screw for 39377.....
1145J	3770	Button Clamp Stop (upper) Lever Spring Screw for 39387.....
39390	3770	Button Clamp Stop (upper) Regulator
233J	3770	" " " " " " Screw.....
39391	3770	Button Clamp Stop (upper) Releasing Arm.....
2269	3770	Button Clamp Stop (upper) Releasing Arm Pin.....
190J	3770	Button Clamp Stop (upper) Releasing Arm Screw.....

NO.	PLATE	NAME
1127J	3769	Button Clamp Stop (upper) Thumb Screw
39392	----	Button Clamp complete, for self-shank buttons, Nos. 90J, 176K, 207J, 714J, 1127J, 1145J, 1180J, 1263J, 1302J, 5569, 17718, 17719, 39375 to 39378, 39380 to 39390, two 1607J and three each 105J, 233J and 1175J, in place of 17898.....
17757	----	Feed Cam with two 1192c, three 17874 and six 190J, in place of 17751.....
39393	3771	Feed Plate with 39394 and two 39395, in place of 17800 and 17923.....
39394	3771	Feed Plate Block.....
39395	3771	" " " Rivet.....
39396	3770	Tension Releaser.....
39397	3770	" " " Bracket with 39399...
217J	3770	" " " Screw.....
229J	3702	" " " Screw.....
39398	3770	Thread Wiper Body, in place of 17865....
766D	3770	" " " Hinge Screw, in place of 1207D.....
39399	3770	Thread Wiper Body Stud, in place of 17866.....
39400	3770	Thread Wiper Body Support Extension
1182J	3770	" " " " " " Screw.....
39401	3770	Thread Wiper Body Wire, in place of 17868.....
39402	3771	Throat Plate with 17749, 39403 and two each 1208D and 50406D, in place of 39292
63843	----	Throat Plate 39402 with 1698E, 39270, 39291, 39488 and 50018F, in place of 39406.....
39403	3771	Throat Plate Needle Hole Bushing, in place of 17871.....

Genuine "SINGER" Needles should be used in "SINGER" Machines. These Needles and their Containers are marked with the Company's Trade Mark "SIMANCO" 1

Needles in Containers marked "FOR SINGER MACHINES" are NOT "SINGER" made needles. 2

MACHINE No. 68-26

FOR STITCHING SELF-SHANK BUTTONS ON SHIRTS, SHIRT-WAISTS, ETC., MAKES EIGHTEEN CROSS AND THREE TYING STITCHES. DIFFERS FROM NO. 68-25 IN NUMBER OF STITCHES.

This Machine is the same as No. 68-1 with the following exceptions:

NO.	PLATE	NAME
39375	3769	Button Clamp (left) in place of 17706....
1175J	3769	" " " Hinge Screw.....
39376	3769	" " (right) in place of 17707...
1175J	3769	" " " Hinge Screw.....
39377	3768	" " Arm with 17711 and 17714, in place of 17901.....
39378	3769	Button Clamp Foot.....
207J	3769	" " " Screw.....
871J	3770	" " Lifting Screw Stud.....
39379	3770	" " Pressure Spring, in place of 17712.....
39380	3769	Button Clamp Spreader Link (left).....
105J	3769	" " " " Hinge Screw for 39375.....
39381	3769	Button Clamp Spreader Link (right).....
105J	3769	" " " " " Hinge Screw for 39376.....
1175J	3769	Button Clamp Spreader Link Hinge Screw for 39392.....
1263J	3769	Button Clamp Spreader Thumb Screw
39382	3769	" " " " " " Block.....
39383	3769	Button Clamp Stop (front).....
39384	3769	" " " " " Arm.....
39385	3769	" " " " " " Holder
39386	3769	" " " " " " " Plate.....
1302J	3769	Button Clamp Stop (front) Arm Holder Plate Screw.....
176K	3769	Button Clamp Stop (front) Arm Screw...
39387	3769	" " " " " Lever.....
105J	3769	" " " " " " Hinge Screw.....
1180J	3769	Button Clamp Stop (front) Lever Thumb Screw.....

NO.	PLATE	NAME
17718	3769	Button Clamp Stop (front) Lever Thumb Screw Washer.....
1607j	3769	Button Clamp Stop (front) Nut.....
17719	3769	" " " " Spring.....
233j	3769	" " " " " Screw..
714j	3769	" " " " " Thumb Screw.....
39388	3769	Button Clamp Stop (upper).....
39389	3770	" " " " Lever.....
90j	3770	" " " " " Hinge Screw.....
5569	3770	Button Clamp Stop (upper) Lever Spring
233j	3769	" " " " " " Screw for 39377.....
1145j	3770	Button Clamp Stop (upper) Lever Spring Screw for 39387.....
39390	3770	Button Clamp Stop (upper) Regulator....
233j	3770	" " " " " Screw
39391	3770	" " " " " Releasing Arm.....
2269	3770	Button Clamp Stop (upper) Releasing Arm Pin.....
190j	3770	Button Clamp Stop (upper) Releasing Arm Screw.....
1127j	3769	Button Clamp Stop (upper) Thumb Screw
39392	—	Button Clamp complete, for self-shank buttons, Nos. 90j, 176k, 207j, 714j, 1127j, 1145j, 1180j, 1263j, 1302j, 5569, 17718, 17719, 39375 to 39378, 39380 to 39390, two 1607j and three each 105j, 233j and 1175j, in place of 17898.....
17756	3712	Feed Cam with two each 1192c, 17874 and four 190j, in place of 17751.....
39393	3771	Feed Plate with 39394 and two 39395, in place of 17800 and 17923.....
39394	3771	Feed Plate Block.....
39395	3771	" " " Rivet.....
39396	3770	Tension Releaser.....
39397	3770	" " Bracket with 39399.....
217j	3770	" " " Screw.....
229j	3702	" " " Screw.....
39398	3770	Thread Wiper Body, in place of 17865....
766D	3770	" " " Hinge Screw, in place of 1207D.....
39399	3770	Thread Wiper Body Stud, in place of 17866.....

NO.	PLATE	NAME
39400	3770	Thread Wiper Body Support Extension
1182j	3770	" " " " " Screw.....
39401	3770	Thread Wiper Body Wire, in place of 17868.....
39402	3771	Throat Plate with 17749, 39403 and two each 1208D and 50406D, in place of 39292.....
63843	—	Throat Plate 39402 with 1698E, 39270, 39291, 39488 and 50018E, in place of 39406.....
39403	3771	Throat Plate Needle Hole Bushing, in place of 17871.....

Genuine "SINGER" Needles should be used in "SINGER" Machines. These Needles and their Containers are marked with the Company's Trade Mark "SIMANCO" 1

Needles in Containers marked "FOR SINGER MACHINES" are NOT "SINGER" made needles. 2

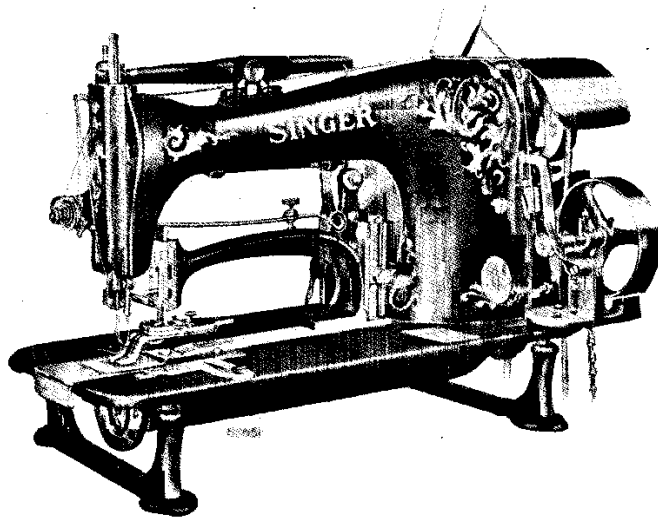

MACHINE No. 68-27

FOR STITCHING PRESS STUDS OR SNAP FASTENERS ON SKIRTS, WAISTS, ETC. MAKES FOURTEEN STITCHES INCLUDING TYING STITCHES. THIS MACHINE IS REGULARLY FITTED WITH A UNIVERSAL ARCH CLAMP FOR THE KOH-I-NOOR SNAP FASTENER. ALSO WITH AN ADJUSTABLE GUIDE, GRADUATED FROM $1\frac{3}{4}$ TO $3\frac{1}{2}$ INCHES, TO REGULATE THE DISTANCE BETWEEN THE SNAP FASTENERS.

This Machine is the same as No. 68-1 with the following exceptions:

NO.	PLATE	NAME
39461	7208	Arch Clamp (left) with 17723.....
39462	7208	" " (right) with 17723.....
39463	7208	" " Arm.....
402j	7208	" " " Screw.....
39464	7209	" " Frame.....
14079	3731	" " " Dowel Pin.....
181j	3738	" " " Screw.....
1175j	3704	" " Hinge Screw.....
17708	3710	" " Lifter with 17866.....

NO.	PLATE	NAME
190j	3710	Arch Clamp Lifter Screw.....
39307	3762	" " Lifting Stud.....
39465	7208	" " Shank with 39307.....
211k	7208	" " " Screw.....
39466	7208	" " " Plate.....
217j	3731	" " " " Screw.....
39467	7208	" " Spreader.....
17717	3705	" " " Lever.....
50237k	3705	" " " " Hinge Screw
1180j	3705	" " " " Locking Thumb Screw.....
17718	3705	Arch Clamp Spreader Lever Locking Thumb Screw Washer.....
1182j	3705	Arch Clamp Spreader Screw.....
39243	3748	" " " " Spring.....
217j	3731	" " " " " Screw.....
7071	3746	" " " " " Washer
17720	3705	" " " " Steady Pin.....
39468	7209	" " Spring.....
747j	7208	" " " " Adjusting Screw.....
1550j	7208	" " " " " Lock Nut.....
39469	7208	Arch Clamp Spring Adjusting Screw Sleeve.....
39470	7208	Arch Clamp Stop with two 17720.....
1183j	3705	" " " " Screw.....
17723	3704	" " Stud.....
39471	—	Arch Clamp complete, Nos. 747j, 1180j, 1182j, 1550j, 1654c, 7071, 17717, 17718, 18459, 39243, 39253, 39461 to 39470, 50237k, two each 181j, 211k, 402j, 1175j, 1183j, 1186c, 1651j, 14079, 17803 and five 217j, in place of 17898.....
*39472	—	Bed, in place of 17704.....
63834	7211	Feed Across Regulator, in place of 17736.
39473	—	" Cam with two 1192c, three 17874 and six 190j, in place of 17751.....
18459	7210	Feed Plate, in place of 17800 and 17923..
*39252	3743	" " " " Carrier Bar, in place of 39259
39253	—	" " " " " 39252 with 934j, 1195e, 8505, 17743, 17802, 17804, 18368, two 7476 and four 17806, in place of 39260.....
36697	5697	Guide.....
36698	5697	" Pointer.....
164j	3724	" " " Screw.....
2049	5697	" Stop Pin.....

**LIST OF PARTS COMPLETE
FOR**

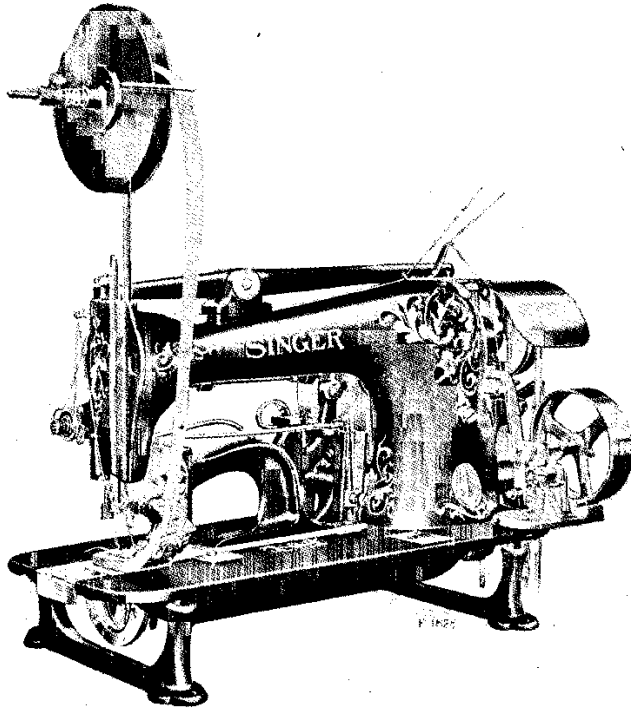

MACHINE No. 68-28

FOR STITCHING LAUNDRY TAGS TO SHIRTS, UNDERWEAR, ETC. ALSO FOR STITCHING REINFORCEMENTS FOR THE BUTTON AND BUTTONHOLE ON KNIT UNDERWEAR. MAKES AN OBLONG TACK 1 INCH LONG, $\frac{1}{8}$ INCH WIDE, CONTAINING FORTY-TWO STITCHES, INCLUDING TYING STITCHES. HAS DEVICE OPERATED BY FOOT TREADLE, FOR FEEDING CUTTING AND CLAMPING THE TAPE BEFORE STITCHING.

NO.	PLATE	NAME
39410	3786	Arch Clamp Check.....

NO.	PLATE	NAME
39411	3786	Arch Clamp Check Lifting Stud.....
191K	3786	" " " Screw.....
39412	3786	" " " Shank with 39411....
39413	3786	" " " Shield.....
1053J	3786	" " " " Screw.....
39414	3789	" " " Spring.....
1229F	3798	" " " " Adjusting Screw
1547J	3798	" " " " " " "
		Lock Nut.....
39415	3789	Arch Clamp Foot.....
63813	—	" " " 39415 with 39413, 39442, 39447 to 39451, 39480, 39481, three each 206F, 1302J, 1472J, five 613J and six 1053J.....
63757	7206	Arch Clamp Foot Lifter with 1340c.....
1340c	7206	" " " " Screw.....
39411	3786	" " " Lifting Stud.....
39478	3786	" " " Plate with 1607E and 2000.....
185J	3786	Arch Clamp Foot Plate Screw.....
191K	3786	" " " Screw.....
39418	3787	" " " Shank with 39411.....
39419	3789	" " " Spring.....
1229F	3767	" " " " Adjusting Screw
1547J	3767	" " " " " " "
		Lock Nut.....
39420	3789	Arch Clamp Frame.....
181J	3738	" " " Screw.....
39482	—	Arch Clamp complete, Nos. 23K, 108J, 658J, 1654c, 39410, 39412, 39414, 39418 to 39420, 39431, 39433, 39438, 39439, 39441, 39443, 39446, 39478, 39479, 63813, two each 181J, 191K, 1053J, 1186c, 1229F, 1547J, 1651J, 17803 and six 185J.....
*63991	—	Arm with 4449, 15404, 17844 and two each 164E and 15405.....
2002	3722	Arm Dowel Pin.....
4448	3722	" Oil Tube for intermediate bearing...
880E	3724	" Screw.....
17702	3728	" Shaft.....
17703	3711	" " Bushing (back).....
50333c	3788	" " " " Adjusting Screw
1520E	3724	" " " " " " "
		Nut.....
*4449	—	Arm Shaft Bushing (front).....

NO.	PLATE	NAME
124674	20334	Arm Side Cover.....
190j	3710	" " " Screw.....
*39423	—	Bed.....
18498	7202	Belt Cover.....
39290	3743	" " Bracket with 184E and 17741..
184E	3753	" " " Screw Stud.....
17741	3701	" " " Stud.....
217j	3731	" " Screw.....
39222	3725	" Shifter.....
63976	7235	" " Clamp.....
1255j	3726	" " " Screw.....
4292	3711	Crank Connecting Rod with two 145E....
145F	3726	" " " Cap Screw.....
375c	3724	" " " Hinge Screw.....
1518E	3718	" " " " Nut..
17724	3711	Face Plate.....
*63736	—	" " 17724 with 2105.....
17725	—	Face Plate complete, Nos. 448c, 2107, 2127, 56791, 63736 and two 233j.....
164j	3724	Face Plate Screw.....
2107	3722	" " Thread Guard.....
233j	3722	" " " " Screw.....
17726	3714	Feed Across Connection Adjusting Stud
1649c	3714	" " " " " "
		Nut (left).....
1650c	3714	Feed Across Connection Adjusting Stud
		Nut (right).....
896E	7235	Feed Across Connection Cap Screw.....
63940	7235	" " " (lever end) with two 896E.....
63941	—	Feed Across Connection (lever end) 63940 with 55381.....
55381	7235	Feed Across Connection (lever end) Ball Stud.....
1185c	3714	Feed Across Connection (lever end) Ball Stud Set Screw.....
63942	7235	Feed Across Connection (regulator end) with two 896E.....
63943	—	Feed Across Connection (regulator end) 63942 with 63944.....
63944	7235	Feed Across Connection (regulator end) Ball Stud.....
17729	3713	Feed Across Lever with 1185c and 1952...
39309	3758	" " " Bracket with 39310 and three 160j.....
*39310	—	Feed Across Lever Bracket Cap.....
160j	3714	" " " " " Screw....

NO.	PLATE	NAME
8589	3722	Feed Across Lever Bracket Dowel Pin....
1177j	3710	" " " " " Screw.....
17737	3714	" " " " Hinge Stud.....
160j	3714	" " " " " Clamping Screw.....
1952	3714	Feed Across Lever Roller and Stud.....
39424	3788	" " Plate with 17741 and 39427..
1186c	3701	" " " Screw.....
1651j	3701	" " " " Nut.....
39425	3792	" " " Spring.....
39426	3788	" " " " Adjusting Bracket
181j	3798	" " " " " " "
		Screw.....
1176D	3788	Feed Across Plate Spring Screw.....
39427	3788	" " " " " Stud.....
39428	3792	" " Regulator.....
50599D	7235	" " " Adjusting Screw Stud.....
1676c	3746	Feed Across Regulator Adjusting Screw Stud Nut.....
46244	7235	Feed Across Regulator Adjusting Screw Stud Nut Washer (fibre).....
17738	3715	Feed Across Regulator Adjusting Screw Stud Nut Washer (steel).....
1188D	3724	Feed Across Regulator Hinge Screw.....
39429	3793	" " " Link.....
1189E	3715	" " " " Screw Stud..
17741	3701	" " " " Stud.....
39430	3791	" Cam with 17874 and two each 190j and 1192c.....
18415	3746	Feed Cam Driving Worm with 1441c and 1442c.....
1442c	3746	Feed Cam Driving Worm Position Screw.
1441c	3746	" " " " Set Screw.....
17797	3713	" " " " Wheel with 453c.....
18384	3753	Feed Cam Driving Worm Wheel Pin.
453c	3715	" " " " " Set Screw
18384	3753	" " Pin.....
1192c	3724	" " Set Screw.....
62155	20334	" " Shaft.....
1653c	3724	" " " Nut.....
39431	3793	" Plate.....
*39432	3792	" " Carrier Bar.....
39433	—	" " " " 39432 with 934j, 1195E, 8505, 17743, 17802, 17804, 18368, two 7476 and four 17806.....

NO.	PLATE	NAME
17802	3701	Feed Plate Carrier Bar Block.....
17803	3701	" " " " " Cover.....
17804	3701	" " " " " Rivet.....
7476	3701	" " " " " Steady Pin
17805	3714	" " " " " Pivot Block.....
1194D	3714	" " " " " " Screw
18368	3714	" " " " " Plate.....
934J	3714	" " " " " " Screw.....
1654c	3701	" " " Nut.....
17806	3701	" " " Position Stud.....
1195E	3701	" " " Screw Stud.....
8505	20333	" " " " Rivet.....
39312	3758	" " " Regulator with 1953.....
17744	3715	" " " Hinge Stud.....
17743	3715	" " " Post.....
1953	3715	" " " Roller and Screw Stud with 1655c and 14017.....
1655c	3715	Feed Regulator Roller and Screw Stud Nut.....
14017	3715	Feed Regulator Roller and Screw Stud Nut Washer.....
1190c	3715	Feed Regulator Stop Screw.....
39313	3759	" " " Swivel.....
1191D	3715	" " " Thumb Screw.....
17807	3717	Knife (needle thread).....
17808	3717	" (shuttle thread).....
*63806	—	" Bar.....
63807	—	" " 63806 with 63808, 63809 and two 17814.....
39299	3752	Knife Bar 63807 with 704c and 39300.....
17810	3700	" " " Cap (back).....
690J	3748	" " " " Screw.....
17811	3700	" " " (front).....
160J	3714	" " " " Screw.....
39262	3754	" " " (intermediate).....
39263	—	" " " " 39262 with 1328E, 1517E, 39264 and 39265.....
690J	3748	Knife Bar Cap (intermediate) Screw.....
39264	3754	" " " " Stop Pin
1328E	3754	" " " " " " "
		Screw Bushing.....
1517E	3754	Knife Bar Cap (intermediate) Stop Pin Screw Bushing Nut.....
39265	3754	Knife Bar Cap (intermediate) Stop Pin Spring.....
63808	7206	Knife Bar Connection.....
17814	3700	" " " Rivet.....

NO.	PLATE	NAME
17915	3700	Knife Bar Connection Slide Block.....
63809	—	" " " " " " 17915 with 63810.....
63810	7206	Knife Bar Connection Slide Block Stud...
39297	3753	" " " Driving Lever with 190J, 1420E, 17919 and 39298.....
1382F	3753	Knife Bar Driving Lever Hinge Screw....
1681c	3753	" " " " " " Nut
39298	3753	" " " " Lock Stud.....
17919	3700	" " " " " " Spring
190J	3710	" " " " " " " Screw.....
1420E	3753	Knife Bar Driving Lever Lock Stud Stop Screw.....
17820	3716	Knife Bar Extension.....
17750	—	" " " 17820 with 17821 and two 17822.....
190J	3710	Knife Bar Extension Screw.....
7071	3746	" " " " Washer.....
17821	3717	" " " Rack.....
17822	3717	" " " Rivet.....
39300	3754	" " " Stop Block.....
19793	3746	" " " " Dowel Pin.....
704c	3754	" " " " Screw.....
39235	3758	" " " Cam Lever Body.....
39409	—	" " " " 39235 with 39460
39329	3758	Knife Cam Lever complete, Nos. 19793 and 39409.....
39332	3758	Knife Cam Lever Bracket with 1177J.....
8589	3722	" " " " Dowel Pin.....
1177J	3710	" " " " Screw.....
50029c	3759	" " " Hinge Screw.....
18471	3759	" " " " " Bushing ...
18472	—	" " " " " " 18471 with 50029c.....
1177J	3710	Knife Cam Lever Hinge Screw Bushing Clamping Screw.....
1980	3759	Knife Cam Lever Roller and Screw Stud with 1654c.....
1654c	3701	Knife Cam Lever Roller and Screw Stud Nut.....
39330	3759	Knife Cam Lever Slide with 1980.....
39460	—	" " " " 39330 with 1255J and 39331.....
1255J	3726	Knife Cam Lever Slide Screw.....
39331	3759	" " " " " Washer....
19793	3746	" " " " Steady Pin.....

NO.	PLATE	NAME
68710	—	Knife Holder.....
39269	3755	" " 68710 with 1336c, 17826, 17830 and two 7298.....
*39488	—	Knife Holder 39269 with 1198c, 17807, 17808 and 17829.....
17826	3717	Knife Holder Pinion.....
7298	3717	" " " Dowel Pin.....
17827	3717	" " " Stud.....
39270	3755	" " " " Bracket with 17827.....
50018f	3753	Knife Holder Pinion Stud Bracket Screw
1698E	3753	" " " " " " "
		Nut.....
1198c	3717	Knife Screw.....
17829	3717	" Thread Holder.....
17830	3717	" " " Position Pin.....
39291	3756	" " Retainer with 39277 and two 39278.....
39277	3755	Knife Thread Retainer Finger.....
39278	3755	" " " Rivet.....
1336c	3755	" " " Screw Stud.....
17831	3716	Needle Bar with 237f.....
*39203	3718	" " Connecting Link.....
63756	—	" " " " 39203 with 21629.....
377c	3718	Needle Bar Connecting Link Hinge Screw
1518E	3718	" " " " " " "
		Nut.....
21629	3718	Needle Bar Connecting Stud with 155c...
155c	3718	" " " " Set Screw...
39350	3743	" " Thread Nipper Driving Lever (adjustable) with 39351 and two 335j...
39351	3759	Needle Bar Thread Nipper Driving Lever Extension.....
335j	3759	Needle Bar Thread Nipper Driving Lever Extension Screw.....
1196c	3721	Needle Bar Thread Nipper Driving Lever Hinge Screw.....
39352	3743	Needle Bar Thread Nipper Driving Lever Spring.....
17834	3718	Needle Bar Thread Nipper Lever with 17835.....
17835	3718	Needle Bar Thread Nipper Lever Bushing
1200d	3718	" " " " " Hinge Screw.....

NO.	PLATE	NAME
39276	3754	Needle Bar Thread Nipper Lever Spring
1329j	3754	" " " " " "
		Screw.....
17837	3716	Needle Bar Thread Nipper Rod.....
17838	3718	" " " " " Adjusting Stud.....
1651E	3701	Needle Bar Thread Nipper Rod Adjusting Stud Lock Nut.....
17839	3718	Needle Bar Thread Nipper Rod Arm with 196f.....
196f	3718	Needle Bar Thread Nipper Rod Arm Set Screw.....
17840	3716	Needle Bar Thread Nipper Rod Support
190j	3710	" " " " " "
		Screw.....
237f	3724	Needle Set Screw.....
4304	3711	Oscillating Rock Shaft with 4784.....
3052	3711	" " " Hinge Pin.....
1513j	3724	" " " " " Nut.....
635c	3724	" " " " " Screw
		Bearing.....
1513j	3724	Oscillating Rock Shaft Hinge Pin Screw Bearing Nut.....
4784	3702	Oscillating Rock Shaft Oil Pad.....
3053	3716	" Shaft.....
*15160	—	" " Crank for 15161.....
15425	—	" " " " 15162.....
*15161	—	Oscillating Shaft Crank complete, Nos 462c, 1519E, 15160 and 15171.....
15162	3702	Oscillating Shaft Crank complete, Nos 1519E, 15171, 15425, and two 462c.....
2049	3702	Oscillating Shaft Crank Pin.....
462c	3702	" " " Set Screw.....
15170	3702	" " " Slide Block.....
226j	7215	" " " " " Cap Screw.....
12424	3702	Oscillating Shaft Crank Slide Block Cap Screw Washer.....
1035c	3702	Oscillating Shaft Crank Slide Block Screw Stud.....
1519E	3702	Oscillating Shaft Crank Slide Block Screw Stud Nut.....
15171	3702	Oscillating Shaft Crank Slide Block com- plete, Nos. 226j, 1035c, 12424 and 15170
63758	7212	Presser Bar.....
17841	3718	" " Collar with two 196f.....
196f	3718	" " " Set Screw.....

NO.	PLATE	NAME
17842	3718	Presser Bar Guide Bracket with 453c.....
453c	3715	" " " " Set Screw.....
17843	3711	" " Lifting Lever.....
17844	3711	" " " " Bracket.....
164E	3724	" " " " Screw.....
1201c	3700	" " " " Hinge Screw.....
17845	3716	" " " " Rod.....
17846	—	" " " " Chain.....
32675	20333	" " Spring.....
68712	20340	Pulleys (loose) 2 $\frac{3}{4}$ in. diam., with 200584d.....
68713	—	" " 68712 with 68714.....
68714	20340	" " Ball Bearing.....
68715	20339	" " Bushing.....
51387a	20339	" " Cap Screw.....
200584d	20339	" " Oil Plug Screw.....
68716	20340	" (tight) 2 $\frac{7}{8}$ in. diam.....
68720	—	" " 68716 with 1206c and 17854.....
2022	3722	" " Pin.....
68717	—	Pulleys (ball bearing) complete, Nos. 51387a, 68713, 68715 and 68720.....
2073	3702	Shuttle Bobbin.....
2211	3702	" " Retaining Spring.....
2212	3702	" " " " Rivet.....
*39295	—	" Body with 398E, 2082, 2084, 2211 and two 2212.....
*2075	—	Shuttle Cover.....
*44001	—	" " 2075 with 112E, 466H, 2078, 2080, 2086 and 2090.....
2076	3702	Shuttle Cover Hinge Pin.....
2078	3702	" Delivery Eye Thread Guard.....
2080	3702	" " " " Rivet.....
2082	3702	" Main Spring.....
398E	3702	" " " Screw.....
2084	3702	" " " Steady Pin.....
466H	3702	" Tension Regulating Screw.....
2086	3702	" " Spring.....
2090	3702	" " " Plate.....
112E	3702	" " " Screw.....
39296	3702	Shuttle complete, Nos. 2073, 2076, 39295 and 44001.....
39487	3702	Shuttle Driver with two 457c.....
2049	3702	" " Pin.....
457c	3702	" " Set Screw.....
17746	3719	" Race Back with 17747.....
190c	3710	" " " Screw.....
17747	3719	" " " Thread Guard Pin.....
63814	—	" " Body.....
63815	3719	Shuttle Race complete, Nos. 17746, 63814 and two 190c.....
158E	3724	Shuttle Race Screw.....

NO.	PLATE	NAME
17853	3720	Starting Lever.....
1262c	3726	" " Hinge Screw.....
1662c	3726	" " " " Nut.....
17886	3716	" " Pitman.....
17854	3721	Stop Cam.....
17855	3721	" " Interlocking Rod.....
63977	7236	" " " " Case.....
63978	—	" " " " " 63977 with 18443 and two 193j.....
63993	—	Stop Cam Interlocking Rod Case 63978 with 63976 and two 1255j.....
*39405	—	Stop Cam Interlocking Rod Case 63993 with 1318d, 17855, 17863, 17864 and 39222.....
39346	3760	Stop Cam Interlocking Rod Case Bracket
63754	—	Stop Cam Interlocking Rod Case Bracket complete, Nos. 1182E, 1196c, 1204E, 1254c, 1262c, 1508E, 1662c, 17853, 17859, 17861, 17862, 17872, 17873, 39346, 39405 and two 898d.....
39347	—	Stop Cam Interlocking Rod Case Bracket 63754 with 39343, 39344 and two 1186j.....
16532	3722	Stop Cam Interlocking Rod Case Bracket Dowel Pin.....
1343E	3753	Stop Cam Interlocking Rod Case Bracket Screw.....
1204E	3721	Stop Cam Interlocking Rod Case Hinge Screw.....
17859	3720	Stop Cam Interlocking Rod Case Socket Joint.....
898d	3721	Stop Cam Interlocking Rod Case Socket Joint Cap Screw.....
39343	3760	Stop Cam Interlocking Rod Case Spring (flat).....
50682c	7235	Stop Cam Interlocking Rod Case Spring Adjusting Screw.....
1520E	3759	Stop Cam Interlocking Rod Case Spring Adjusting Screw Nut.....
39344	3759	Stop Cam Interlocking Rod Case Spring Bracket with 1520E and 50682c.....
1186j	3701	Stop Cam Interlocking Rod Case Spring Bracket Screw.....
17861	3721	Stop Cam Interlocking Rod Case Stop Stud.....
1254c	3726	Stop Cam Interlocking Rod Case Stop Stud Screw Bushing.....

NO.	PLATE	NAME
1508E	3726	Stop Cam Interlocking Rod Case Stop Stud Screw Bushing Lock Nut.....
17862	3721	Stop Cam Interlocking Rod Case Stop Stud Spring.....
18443	3754	Stop Cam Interlocking Rod Case Wearing Block.....
193J	3754	Stop Cam Interlocking Rod Case Wearing Block Screw.....
17863	3721	Stop Cam Interlocking Rod Spring.....
17864	3721	" " " " Stop.....
1318D	3748	" " " " " Screw...
3012	3722	" " Pin.....
1206c	3721	" " Screw.....
39438	3787	Tape Cutting Blade.....
1053J	3786	" " " Screw.....
39439	3787	" Feeding Foot with 1823.....
658J	3787	" " " Head.....
39479	3787	" " " Holder.....
23K	3787	" " " " Hinge Screw..
2000	3786	" " " " Roller and Screw Stud.....
1607E	3786	Tape Feeding Foot Holder Roller and Screw Stud Nut.....
39441	3787	Tape Feeding Foot Latch.....
39442	3787	" " " " Disengaging Wedge.....
613J	3787	Tape Feeding Foot Latch Disengaging Wedge Screw.....
108J	3787	Tape Feeding Foot Latch Hinge Screw...
39443	3787	" " " " Spring.....
1823	3787	" " " " Roller and Stud.....
39480	3787	" " " " Plate (back)
206F	3787	" " " " " " Screw.....
39481	3787	Tape Feeding Foot Roller Plate (front)
206F	3787	" " " " " " Screw.....
39446	3787	Tape Feeding Foot Spring.....
39447	3789	" Guide and Cutter.....
39448	3788	" " " " Spring.....
39449	3788	" " " " " Bracket for 39415.....
39450	3788	Tape Guide and Cutter Spring Bracket for 39447.....
613J	3787	Tape Guide and Cutter Spring Bracket Screw.....

NO.	PLATE	NAME
39451	3788	Tape Guide Cap.....
1472J	3788	" " " " Screw (back).....
1302J	3788	" " " " (front).....
2102	3722	Tension Disc.....
1560c	3722	" Regulating Thumb Nut.....
600c	3722	" Screw Stud.....
16202	—	" " " 600c with 1560c.....
448c	3722	" " " Set Screw.....
2103	3722	" Spring.....
2105	3722	" Thread Guard.....
56791	—	Tension complete, Nos. 2103, 2124, 16202 and two 2102.....
*63749	—	Thread Take-up Cam.....
39204	3711	" " " 63749 with 446c....
3012	3722	" " " Pin.....
446c	3724	" " " Set Screw.....
*3072	3711	" " " Lever with 1819.....
56855	—	" " " 3072 with 1088c..
1088c	7213	" " " Hinge Screw.....
1819	3724	" " " Roller and Stud..
2124	3722	" " " Spring.....
2127	3722	" " " Regulator Plate
233J	3722	" " " " " " " " Adjusting Screw.....
39452	3796	Thread Wiper Body.....
39453	3796	" " " " Finger
330J	3796	" " " " " Screw.....
1207D	3710	" " " " Hinge Screw.....
39454	3796	" " " " Support.....
641c	3726	" " " " " Set Screw.....
39455	3796	" " " " Wire.....
39456	3796	" " " " " Clamp.....
1302J	3788	" " " " " " Screw...
39457	3797	Throat Plate with 17749, 39213 and two each 1208D, 39458 and 50406D.....
39477	—	Throat Plate 39457 with 1698E, 39270, 39291, 39488 and 50018F.....
17749	3723	Throat Plate Extension.....
50406D	7213	" " " " " Screw.....
39213	3731	" " " " Needle Hole Bushing.....
1208D	3723	" " " " " " Screw..
39458	3797	" " " " Oil Pad.....
691F	3724	" " " " " Screw.....
17872	3721	Trip Lever.....
1196c	3721	" " " Hinge Screw.....
17873	3721	" " " Spring.....
1182E	3705	" " " " " Screw.....

NO.	PLATE	NAME
17874	3717	Tripping Point.....
190j	3710	" " Screw.....
*15404	—	Trade Mark.....
15405	20333	" " Rivet.....

MACHINE No. 68-29

FOR STITCHING TWO OR FOUR-HOLE GROOVED BUTTONS ON MEN'S AND BOYS' CLOTHING. MAKES TWO SEPARATE BARS IN FOUR-HOLE BUTTONS. NO CROSS STITCHES BETWEEN THE BARS. AFTER THE FIRST BAR IS COMPLETED AND THE THREAD CUT, THE CLAMP AUTOMATICALLY BRINGS THE BUTTON INTO POSITION FOR THE SECOND BAR. MAKES NINE STITCHES, INCLUDING THREE TYING STITCHES TO EACH BAR.

This Machine is the same as No. 68-1 with the following exceptions:

NO.	PLATE	NAME
17779	—	Feed Cam with two 1192c and four each 190j and 17874, in place of 17751.....
39211	3746	Feed Cam Driving Worm with 1441c and 1442c, in place of 18415.....
39212	3743	Feed Cam Driving Worm Wheel with 453c, in place of 17797.....

MACHINE No. 68-30

FOR STITCHING TWO OR FOUR-HOLE GROOVED BUTTONS ON MEN'S AND BOYS' CLOTHING. MAKES TWO SEPARATE BARS IN FOUR-HOLE BUTTONS. NO CROSS STITCHES BETWEEN THE BARS. AFTER THE FIRST BAR IS COMPLETED AND THE THREAD CUT, THE CLAMP AUTOMATICALLY BRINGS THE BUTTON INTO POSITION FOR THE SECOND BAR. MAKES EIGHTEEN STITCHES, INCLUDING THREE TYING STITCHES TO EACH BAR.

This Machine is the same as No. 68-1 with the following exceptions:

NO.	PLATE	NAME
17780	—	Feed Cam with two each 1192c, 17874 and four 190j, in place of 17751.....
39211	3746	Feed Cam Driving Worm with 1441c and 1442c, in place of 18415.....
39212	3743	Feed Cam Driving Worm Wheel with 453c, in place of 17797.....

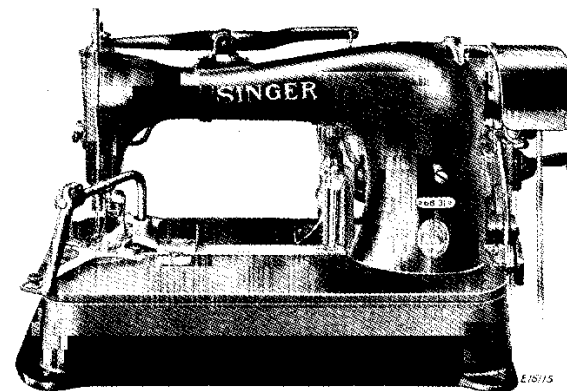

MACHINE No. 68-31

FOR SMOCKING LADIES' BLOUSES, SHIRTWAISTS, NIGHT-DRESSES, UNDERWEAR, DRESSES, SKIRTS, MILLINERY, CHILDREN'S WEAR, ETC. HAS WORK HOLDING CLAMP WITH GRADUATED PLATE FOR MEASURING DISTANCE BETWEEN THE TACKS. MAKES FOURTEEN STITCHES TO EACH TACK. THE DEPTH OF THE DEPRESSION OF THE DIAMOND CAN BE MADE EITHER $\frac{1}{4}$ OR $\frac{1}{8}$ INCH AS DESIRED.

This Machine is the same as No. 68-1 with the following exceptions:

NO.	PLATE	NAME
17757	—	Feed Cam with two 1192c, three 17874 and six 190j, in place of 17751.....
63701	7210	Feed Plate, in place of 17800 and 17923 ..
*63702	7212	" " Carrier Bar, in place of 39259
63703	—	" " " " 63702 with 934j, 1195e, 8505, 17743, 17802, 17804, 18368, two 7476 and three 17806, in place of 39260.....
63704	7212	Smocking Clamping Blade.....
63705	7213	" " " " Holder.....
63706	7212	" " " " Bracket with 1120k and two 1259c.....

NO.	PLATE	NAME
172j	7213	Smocking Clamping Blade Holder Bracket Screw.....
42007	7213	Smocking Clamping Blade Holder Hinge Pin.....
27659	7213	Smocking Clamping Blade Holder Hinge Pin Collar with 237k.....
237k	3724	Smocking Clamping Blade Holder Hinge Pin Collar Set Screw.....
1120k	7213	Smocking Clamping Blade Holder Hinge Pin Set Screw.....
63707	7212	Smocking Clamping Blade Holder Spring.
63708	7213	" " " Lifting Hook
1651j	3701	" " " " "
		Lock Nut.....
190j	3710	Smocking Clamping Blade Screw.....
63709	7212	" Guide (left) 1/4 in.....
63710	—	" " " 5/16 in.....
63711	7212	" " (right) 1/4 in.....
63712	—	" " " 5/16 in.....
63713	7212	" " Holder with two 1057e..
63714	7212	" " " Arm.....
1259c	7213	" " " Set Screw...
1057e	7213	" " " Clamping Screw.
287j	7213	" " Thumb Screw.....
63715	7213	" Indicator (left).....
107j	7213	" " " Hinge Screw
22232	7213	" " " " "
		Friction Washer.....
63716	7213	Smocking Indicator (right).....
107j	7213	" " " Hinge Screw
22232	7213	" " " " "
		Friction Washer.....
63717	—	Smocking Attachment complete, Nos. 287j, 1654c, 27659, 42007, 63701, 63703 to 63716 and two each 107j, 172j, 190j, 1186c, 17803, 22232 and three 1651j, in place of 17898.....
17708	3710	Smocking Attachment Lifter with 17866..
190j	3710	" " " Screw.....

LIST OF PARTS COMPLETE

FOR

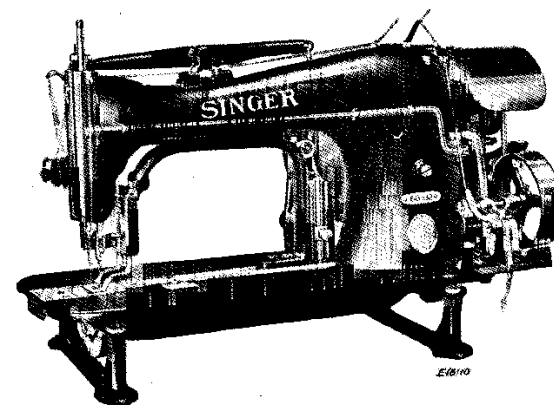

MACHINE No. 68-32

FOR BARRING POCKETS AND COLLARS ON ARMY OVERCOATS AND OTHER SIMILAR HEAVY WORK. MAKES BAR 5/16 INCH TO 5/8 INCH LONG, CONSISTING OF TWELVE STAYING, TWENTY-SEVEN COVERING AND THREE TYING STITCHES. THE MACHINE IS DESIGNED TO HANDLE FABRIC MATERIAL 5/8 INCH THICK.

NO.	PLATE	NAME
17964	3733	Arch Clamp Foot (left) with 17959.....
17965	3733	" " " (right) with 17959.....
63837	7213	" " " Lifter.....
190j	3710	" " " Screw.....
17959	8731	" " " Lifting Stud.....
63838	7213	" " " Plate.....
217j	3731	" " " Screw.....
39302	3731	" " " Spring.....
17967	3733	" " " Connection.....
1175j	3704	" " " " " Hinge
		Screw.....

From the library of: Diamond Needle Corp

NO.	PLATE	NAME
217J	3731	Arch Clamp Foot Spring Screw.....
17968	3732	" " Frame.....
14079	3731	" " " Dowel Pin.....
1177J	3710	" " " Screw.....
63839	—	Arch Clamp complete, Nos. 1654c, 17964, 17965, 17967, 17968, 17970, 39254, 39302, 63838, two each 1175J, 1177J, 1186c, 1651J, 14079, 17803 and five 217J.....
*63990	—	Arm with 4449, 15404, 17844 and two each 164E and 15405.....
2002	3722	Arm Dowel Pin.....
4448	3722	" Oil Tube for intermediate bearing...
880E	3724	" Screw.....
17702	3728	" Shaft.....
17703	3711	" " Bushing (back).....
50333c	3788	" " " " Adjusting Screw
1520E	3724	" " " " " " " Nut.....
*4449	—	Arm Shaft Bushing (front).....
124674	20334	" Side Cover.....
190J	3710	" " " Screw.....
*17704	—	Bed.....
18498	7202	Belt Cover.....
39290	3743	" " Bracket with 184E and 17741.
184E	3753	" " " Screw Stud.....
17741	3701	" " " Stud.....
217J	3731	" " " Screw.....
39222	3725	" Shifter.....
63976	7235	" " Clamp.....
1255J	3726	" " " Screw.....
4292	3711	Crank Connecting Rod with two 145E....
145E	3726	" " " Cap Screw.....
375c	3724	" " " Hinge Screw.....
1518E	3718	" " " " " Nut.....
17724	3711	Face Plate.....
*63736	—	" " 17724 with 2105.....
17725	—	Face Plate complete, Nos. 448c, 2107, 2127, 56791, 63736 and two 233J.....
164J	3724	Face Plate Screw.....
2107	3722	" " Thread Guard.....
233J	3722	" " " " Screw.....
17726	3714	Feed Across Connection Adjusting Stud
1649c	3714	" " " " " Nut (left).....
1650c	3714	Feed Across Connection Adjusting Stud Nut (right).....

NO.	PLATE	NAME
896E	7235	Feed Across Connection Cap Screw.....
63940	7235	" " " (lever end) with two 896E.....
63941	—	Feed Across Connection (lever end) 63940 with 55381.....
55381	7235	Feed Across Connection (lever end) Ball Stud.....
1185c	3714	Feed Across Connection (lever end) Ball Stud Set Screw.....
63942	7235	Feed Across Connection (regulator end) with two 896E.....
63943	—	Feed Across Connection (regulator end) 63942 with 63944.....
63944	7235	Feed Across Connection (regulator end) Ball Stud.....
17729	3713	Feed Across Lever with 1185c and 1952...
17731	3713	" " " Bracket with 17732 and three 160J.....
*17732	—	Feed Across Lever Bracket Cap.....
160J	3714	" " " " " Screw.....
8589	3722	" " " " Dowel Pin....
1177J	3710	" " " " Screw.....
17737	3714	" " " Hinge Stud.....
160J	3714	" " " " " Clamping Screw.....
1952	3714	Feed Across Lever Roller and Stud.....
17735	3701	" " Plate with 17741.....
1186c	3701	" " " Screw.....
1651J	3701	" " " " Nut.....
17736	3713	" " Regulator.....
50599D	7235	" " " Adjusting Screw Stud.....
1676c	3746	Feed Across Regulator Adjusting Screw Stud Nut.....
46244	7235	Feed Across Regulator Adjusting Screw Stud Nut Washer (fibre).....
17738	3715	Feed Across Regulator Adjusting Screw Stud Nut Washer (steel).....
1188D	3724	Feed Across Regulator Hinge Screw.....
17740	3715	" " " Link.....
1189E	3715	" " " " Screw Stud..
17741	3701	" " " " Stud.....
18398	—	" Cam with 17874 and two each 190J and 1192c.....
18415	3746	Feed Cam Driving Worm with 1441c and 1442c.....

NO.	PLATE	NAME
39300	3754	Knife Bar Stop Block.....
19793	3746	" " " " Dowel Pin.....
704c	3754	" " " " Screw.....
39235	3758	" Cam Lever Body.....
39409	—	" " " " 39235 with 39460.
39329	3758	Knife Cam Lever complete, Nos. 19793 and 39409.....
39332	3758	Knife Cam Lever Bracket with 1177j....
8589	3722	" " " " Dowel Pin.....
1177j	3710	" " " " Screw.....
50029c	3759	" " " " Hinge Screw.....
18471	3759	" " " " " Bushing
18472	—	" " " " " "
		18471 with 50029c.....
1177j	3710	Knife Cam Lever Hinge Screw Bushing Clamping Screw.....
1980	3759	Knife Cam Lever Roller and Screw Stud with 1654c.....
1654c	3701	Knife Cam Lever Roller and Screw Stud Nut.....
39330	3759	Knife Cam Lever Slide with 1980.....
39460	—	" " " " 39330 with 1255j and 39331.....
1255j	3726	Knife Cam Lever Slide Screw.....
39331	3759	" " " " " Washer....
19793	3746	" " " " " Steady Pin.....
68710	—	" Holder.....
39269	3755	" " 68710 with 1336c, 17826, 17830 and two 7298.....
63844	—	Knife Holder 39269 with 1198c, 17808, 17829 and 68706.....
17826	3717	Knife Holder Pinion.....
7298	3717	" " " " Dowel Pin.....
17827	3717	" " " " Stud.....
39270	3755	" " " " Bracket with 17827.....
50018f	3753	Knife Holder Pinion Stud Bracket Screw
1698e	3753	" " " " " " "
		Nut.....
1198c	3717	Knife Screw.....
17829	3717	" Thread Holder.....
17830	3717	" " " " Position Pin.....
39291	3756	" " Retainer with 39277 and two 39278.....
39277	3755	Knife Thread Retainer Finger.....
39278	3755	" " " " Rivet.....
1336c	3755	" " " " Screw Stud.....

NO.	PLATE	NAME
17831	3716	Needle Bar with 237f.....
*39203	3718	" " Connecting Link.....
63756	—	" " " " 39203 with 21629.....
377c	3718	Needle Bar Connecting Link Hinge Screw
1518e	3718	" " " " " "
		Nut.....
21629	3718	Needle Bar Connecting Stud with 155c...
155c	3718	" " " " Set Screw...
39350	3743	" " Thread Nipper Driving Lever (adjustable) with 39351 and two 335r..
39351	3759	Needle Bar Thread Nipper Driving Lever Extension.....
335j	3759	Needle Bar Thread Nipper Driving Lever Extension Screw.....
1196c	3721	Needle Bar Thread Nipper Driving Lever Hinge Screw.....
39352	3743	Needle Bar Thread Nipper Driving Lever Spring.....
17834	3718	Needle Bar Thread Nipper Lever with 17835.....
17835	3718	Needle Bar Thread Nipper Lever Bushing
1200b	3718	" " " " " Hinge Screw.....
39276	3754	Needle Bar Thread Nipper Lever Spring
1329j	3754	" " " " " "
		Screw.....
17837	3716	Needle Bar Thread Nipper Rod.....
17838	3718	" " " " " Adjusting Stud.....
1651e	3701	Needle Bar Thread Nipper Rod Adjusting Stud Lock Nut.....
17839	3718	Needle Bar Thread Nipper Rod Arm with 196f.....
196f	3718	Needle Bar Thread Nipper Rod Arm Set Screw.....
17840	3716	Needle Bar Thread Nipper Rod Support
190j	3710	" " " " " "
		Screw.....
237f	3724	Needle Set Screw.....
4304	3711	Oscillating Rock Shaft with 4784.....
3052	3711	" " " " Hinge Pin.....
1513j	3724	" " " " " Nut...
635c	3724	" " " " " Screw
		Bearing.....
1513j	3724	Oscillating Rock Shaft Hinge Pin Screw Bearing Nut.....

NO.	PLATE	NAME
4784	3702	Oscillating Rock Shaft Oil Pad.....
3168	7211	" Shaft.....
15163	—	" " Crank for 15164.....
15426	—	" " " " 15165.....
*15164	—	Oscillating Shaft Crank complete, Nos. 462c, 1519e, 15163 and 15171.....
15165	7213	Oscillating Shaft Crank complete, Nos. 1519e, 15171, 15426 and two 462c.....
2049	3702	Oscillating Shaft Crank Pin.....
462c	3702	" " " Set Screw.....
15170	3702	" " " Slide Block.....
226j	7215	" " " " " Cap Screw.....
12424	3702	Oscillating Shaft Crank Slide Block Cap Screw Washer.....
1035c	3702	Oscillating Shaft Crank Slide Block Screw Stud.....
1519e	3702	Oscillating Shaft Crank Slide Block Screw Stud Nut.....
15171	3702	Oscillating Shaft Crank Slide Block complete, Nos. 226j, 1035c, 12424 and 15170
2058	3716	Presser Bar.....
17841	3718	" " Collar with two 196f.....
196f	3718	" " " Set Screw.....
17842	3718	" " Guide Bracket with 453c.....
453c	3715	" " " " Set Screw.....
17843	3711	" " Lifting Lever.....
17844	3711	" " " Bracket.....
164e	3724	" " " " " Screw.....
1201c	3700	" " " " Hinge Screw.....
17845	3716	" " " " Rod.....
17846	—	" " " " " Chain.....
32675	20333	" " Spring.....
68712	20340	Pulley (loose) 2 3/4 in. diam., with 200584d.
68713	—	" " 68712 with 68714.....
68714	20340	" " Ball Bearing.....
68715	20339	" " Bushing.....
51387r	20339	" " Cap Screw.....
200584d	20339	" " Oil Plug Screw.....
68716	20340	" (tight) 2 3/4 in. diam.....
68720	—	" " 68716 with 1206c and 17854
2022	3722	" " Pin.....
68717	—	Pulleys (ball bearing) complete, Nos. 51387r, 68713, 68715 and 68720.....
2996	7214	Shuttle Bobbin.....
33941	—	" " Case.....
15140	7214	" " " Latch.....
2973	7214	" " " " Lever.....
2974	7214	" " " " " Fulcrum Pin.....

NO.	PLATE	NAME
2975	7214	Shuttle Bobbin Case Latch Spring.....
592e	7214	" " " " Stop Screw...
15141	—	Shuttle Bobbin Case Hinge, Nos. 2973, 2974 and 15140.....
7553	7214	Shuttle Bobbin Case Position Finger.....
2523	7214	" " " " " Rivet
33942	7235	Shuttle Bobbin Case complete, Nos. 591f, 592e, 2523, 2975, 7553, 15141, 15278 and 33941.....
24412	7214	Shuttle Bobbin Case Position Plate.....
391j	7214	" " " " " Screw
2515	7214	" Body.....
591f	7214	" Tension Regulating Screw.....
15278	7235	" " Spring.....
63535	—	Shuttle, 1 1/4 in. diam., Nos. 2515, 2996 and 33942.....
*2542	—	Shuttle Driver.....
2441	7214	" " 2542 with two 462c.....
2049	3702	" " Pin.....
462c	3702	" " Set Screw.....
2531	7211	" Race Back.....
2532	7214	" " " Position Pin.....
2533	7211	" " " Spring.....
907d	7214	" " " " Screw.....
63840	—	" " Body.....
63946	—	" " " 63840 with 1053j, 2523 and 63841.....
63841	7214	Shuttle Race Cap.....
1053j	3786	" " " Screw.....
2523	7214	" " " Steady Pin.....
63842	7211	Shuttle Race complete, Nos. 907d, 2531, 2533, 24412, 63946 and two each 391j and 2532.....
145j	3726	Shuttle Race Screw.....
17853	3720	Starting Lever.....
1262c	3726	" " Hinge Screw.....
1662c	3726	" " " " Nut.....
17886	3716	" " Pitman.....
17854	3721	Stop Cam.....
17855	3721	" " Interlocking Rod.....
63977	7236	" " " " Case.....
63978	—	" " " " " 63977 with 18443 and two 193j.....
63993	—	Stop Cam Interlocking Rod Case 63978 with 63976 and two 1255j.....
*39405	—	Stop Cam Interlocking Rod Case 63993 with 1318d, 17855, 17863, 17864 and 39222.....

NO.	PLATE	NAME
39348	3760	Stop Cam Interlocking Rod Case Bracket
63752	—	Stop Cam Interlocking Rod Case Bracket complete, Nos. 1182E, 1196c, 1204E, 1254c, 1262c, 1508E, 1662c, 17853, 17859, 17861, 17862, 17872, 17873, 39348, 39405 and two 898D.....
39349	—	Stop Cam Interlocking Rod Case Bracket 63752 with 39343, 39344 and two 1186J
16532	3722	Stop Cam Interlocking Rod Case Bracket Dowel Pin.....
1343E	3753	Stop Cam Interlocking Rod Case Bracket Screw.....
1204E	3721	Stop Cam Interlocking Rod Case Hinge Screw.....
17859	3720	Stop Cam Interlocking Rod Case Socket Joint.....
898D	3721	Stop Cam Interlocking Rod Case Socket Joint Cap Screw.....
39343	3760	Stop Cam Interlocking Rod Case Spring (flat).....
50682c	7235	Stop Cam Interlocking Rod Case Spring Adjusting Screw.....
1520E	3759	Stop Cam Interlocking Rod Case Spring Adjusting Screw Nut.....
39344	3759	Stop Cam Interlocking Rod Case Spring Bracket with 1520E and 50682c.....
1186J	3701	Stop Cam Interlocking Rod Case Spring Bracket Screw.....
17861	3721	Stop Cam Interlocking Rod Case Stop Stud.....
1254c	3726	Stop Cam Interlocking Rod Case Stop Stud Screw Bushing.....
1508E	3726	Stop Cam Interlocking Rod Case Stop Stud Screw Bushing Lock Nut.....
17862	3721	Stop Cam Interlocking Rod Case Stop Stud Spring.....
18443	3754	Stop Cam Interlocking Rod Case Wearing Block.....
193J	3754	Stop Cam Interlocking Rod Case Wearing Block Screw.....
17863	3721	Stop Cam Interlocking Rod Spring.....
17864	3721	" " " " Stop.....
1318D	3748	" " " " " Screw...
3012	3722	" " Pin.....
1206c	3721	" " Screw.....
2102	3722	Tension Disc.....
1560c	3722	" Regulating Thumb Nut.....

NO.	PLATE	NAME
600c	3722	Tension Screw Stud.....
16202	—	" " " 600c with 1560c.....
448c	3722	" " " Set Screw.....
2103	3722	" Spring.....
2105	3722	" Thread Guard.....
56791	—	Tension complete, Nos. 2103, 2124, 16202 and two 2102.....
*55302	—	Thread Take-up Cam.....
18392	7211	" " " 55302 with 446c....
3012	3722	" " " Pin.....
446c	3724	" " " Set Screw.....
*18393	3752	" " " Lever with 1822.....
55283	—	" " " 18393 with 79c....
79c	3753	" " " Hinge Screw.....
1822	3753	" " " Roller and Stud...
2124	3722	" " " Spring.....
2127	3722	" " " Regulator Plate
233J	3722	" " " " " " "
		Adjusting Screw.....
39452	3796	Thread Wiper Body.....
39453	3796	" " " Finger.....
330J	3796	" " " " Screw.....
1207D	3710	" " " Hinge Screw.....
59787	7214	" " " Support.....
641c	3726	" " " " Set Screw...
39455	3796	" " " Wire.....
39456	3796	" " " " Clamp.....
1302J	3769	" " " " " Screw..
63997	—	Throat Plate Body.....
63786	—	" " " 63997 with 17749, 39486 and two each 1208D and 50406D.....
63845	—	Throat Plate 63786 with 1698E, 39270, 39291, 50018F and 63844.....
17749	3723	Throat Plate Extension.....
50406D	7213	" " " " Screw.....
39486	7214	" " " Needle Hole Bushing.....
1208D	3723	" " " " " " Screw
691F	3724	" " " " " " Screw.....
17872	3721	Trip Lever.....
1196c	3721	" " " Hinge Screw.....
17873	3721	" " " Spring.....
1182E	3705	" " " " Screw.....
17874	3717	Tripping Point.....
190J	3710	" " " Screw.....
*15404	—	Trade Mark.....
15405	20333	" " " Rivet.....

**LIST OF PARTS COMPLETE
FOR**

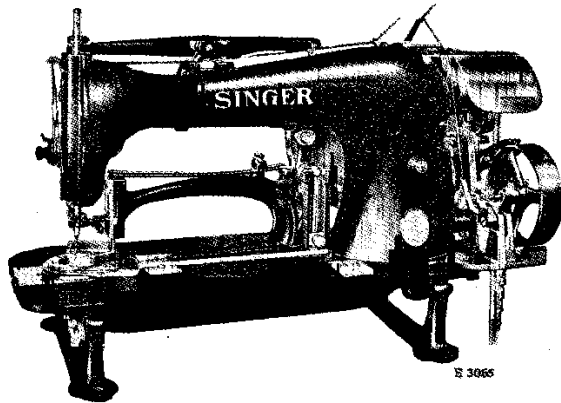

MACHINE No. 68-33

FOR MAKING FIVE-POINTED STARS IN FIVE OPERATIONS OR A CROW'S FOOT TACK (THREE POINTED STAR) IN THREE OPERATIONS, ON NAVAL CLOTHING AND OTHER FABRIC. FORTY-TWO STITCHES TO EACH TACK OR POINT OF STAR. THE MACHINE IS FITTED WITH A SPECIALLY DESIGNED WORK HOLDING CLAMP FOR MANUALLY MOVING THE MATERIAL IN POSITION FOR THE SUCCEEDING POINTS OF THE STAR.

NO.	PLATE	NAME
63734	7207	Arch Clamp Frame.....
14079	3731	" " Dowel Pin.....
181J	3738	" " " Screw.....
63816	7215	" " Indicator Finger.....
226J	7215	" " " Screw.....
63761	7216	" " " Plate.....
229J	3702	" " " Screw.....
17958	3733	" " Lifter with 17866.....
190J	3710	" " " Screw.....

NO.	PLATE	NAME
63763	7216	Arch Clamp Ratchet Lever.....
63764	7215	" " " " Pawl.....
50436J	7215	" " " " Hinge Screw.....
63765	7215	Arch Clamp Ratchet Lever Pawl Spring..
63766	7216	" " " Ring.....
63767	7215	" " " " Position Pin...
63846	7216	" " Ring with 63767 and ten 63789.....
63847	7215	Arch Clamp Ring Compensating Stud
8282	7215	" " " " " "
		Spring.....
63848	7216	Arch Clamp Ring Holder.....
108J	3787	" " " " Hinge Screw....
63849	7216	" " " " Shank with 50458J.....
50458J	7215	Arch Clamp Ring Holder Shank Lifting Screw Stud.....
18477	3767	Arch Clamp Ring Holder Shank Plate
190J	3710	" " " " " " "
		Screw.....
63850	7215	Arch Clamp Ring Leveling Stud.....
63851	7215	" " " " " Holder with two 50301c.....
63852	—	Arch Clamp Ring Leveling Stud Holder complete, Nos. 63851 and two each 50150c, 52544, 63850 and 63853.....
217J	3731	Arch Clamp Ring Leveling Stud Holder Screw.....
63853	7215	Arch Clamp Ring Leveling Stud Holder Screw Bushing.....
50301c	7215	Arch Clamp Ring Leveling Stud Holder Screw Bushing Set Screw.....
52544	7215	Arch Clamp Ring Leveling Stud Spring
50150c	7215	" " " " " " " Screw.....
63789	7215	Arch Clamp Ring Spur.....
63772	7215	" " " Stop.....
18480	3739	" " Spring.....
1229c	3767	" " " Adjusting Screw....
1547J	3798	" " " " " Lock Nut.....

NO.	PLATE	NAME
63854	—	Arch Clamp complete, Nos. 217j, 226j, 1654c, 18477, 39360, 50436j, 63734, 63761, 63763, to 63766, 63772, 63774, 63796, 63816, 63846, 63848, 63849, 63852, two each 108j, 181j, 1186c, 1229c, 1547j, 1651j, 14079, 17803, 18480, four 190j, five 229j and ten each 8282 and 63847.....
*63992	—	Arm with 4449, 15404, 17844 and two each 164e and 15405.....
2002	3722	Arm Dowel Pin.....
4448	3722	" Oil Tube for intermediate bearing...
880E	3724	" Screw.....
17702	3728	" Shaft.....
17703	3711	" " Bushing (back).....
50333c	3788	" " " " Adjusting Screw.....
1520E	3724	Arm Shaft Bushing (back) Adjusting Screw Nut.....
*4449	—	Arm Shaft Bushing (front).....
124674	20334	" Side Cover.....
190j	3710	" " " Screw.....
*63805	—	Bed.....
18498	7202	Belt Cover.....
39290	3743	" " Bracket with 184e and 17741.
184E	3753	" " " Screw Stud.....
17741	3701	" " " Stud.....
217j	3731	" " " Screw.....
39222	3725	" Shifter.....
63976	7235	" " (Clamp).....
1255j	3726	" " " Screw.....
4292	3711	Crank Connecting Rod with two 145e....
145E	3726	" " " Cap Screw.....
375c	3724	" " " Hinge Screw.....
1518E	3718	" " " " Nut.....
17724	3711	Face Plate.....
*63736	—	" " 17724 with 2105.....
17725	—	Face Plate complete, Nos. 448c, 2107, 2127, 56791, 63736 and two 233j.....
164j	3724	Face Plate Screw.....
2107	3722	" " Thread Guard.....
233j	3722	" " " " Screw.....
17726	3714	Feed Across Connection Adjusting Stud
1649c	3714	" " " " " Nut (left).....
1650c	3714	Feed Across Connection Adjusting Stud Nut (right).....

NO.	PLATE	NAME
896E	7235	Feed Across Connection Cap Screw.....
63940	7235	" " " (lever end) with two 896E.....
63941	—	Feed Across Connection (lever end) 63940 with 55381.....
55381	7235	Feed Across Connection (lever end) Ball Stud.....
1185c	3714	Feed Across Connection (lever end) Ball Stud Set Screw.....
63942	7235	Feed Across Connection (regulator end) with two 896E.....
63943	—	Feed Across Connection (regulator end) 63942 with 63944.....
63944	7235	Feed Across Connection (regulator end) Ball Stud.....
17729	3713	Feed Across Lever 1185c and 1952.....
39309	3758	" " " Bracket with 39310 and three 160j.....
*39310	—	Feed Across Lever Bracket Cap.....
160j	3714	" " " " " Screw....
8589	3722	" " " " Dowel Pin....
1177j	3710	" " " " Screw.....
17737	3714	" " " Hinge Stud.....
160j	3714	" " " " " Clamping Screw.....
1952	3714	Feed Across Lever Roller and Stud.....
17735	3701	" " Plate with 17741.....
1186c	3701	" " " Screw.....
1651j	3701	" " " " Nut.....
17736	3713	" " Regulator.....
50599D	7235	" " " Adjusting Screw Stud.....
1676c	3746	Feed Across Regulator Adjusting Screw Stud Nut.....
46244	7235	Feed Across Regulator Adjusting Screw Stud Nut Washer (fibre).....
17738	3715	Feed Across Regulator Adjusting Screw Stud Nut Washer (steel).....
1188D	3724	Feed Across Regulator Hinge Screw.....
17740	3715	" " " Link.....
1189E	3715	" " " " Screw Stud..
17741	3701	" " " " Stud.....
17783	—	" Cam with 17874 and two each 190j and 1192c.....
18415	3746	Feed Cam Driving Worm with 1441c and 1442c.....

NO.	PLATE	NAME
1442c	3746	Feed Cam Driving Worm Position Screw.
1441c	3746	" " " " Set Screw.....
17797	3713	" " " " Wheel with 453c
18384	3753	" " " " " Pin.....
453c	3715	" " " " " Set Screw
18384	3753	" " Pin.....
1192c	3724	" " Set Screw.....
62155	20334	" " Shaft.....
1653c	3724	" " " Nut.....
63774	7216	" Plate.....
*39359	3739	" " Carrier Bar.....
39360	—	" " " " 39359 with 810d, 934j, 1195e, 8505, 17802, 17804, 18368, 18488, 18489, two 7476 and four 17806..
17802.	3701	Feed Plate Carrier Bar Block.....
17803	3701	" " " " " Cover.....
17804	3701	" " " " " Rivet.....
7476	3701	" " " " " Steady Pin
17805	3714	" " " " " Pivot Block.....
1194d	3714	" " " " " " Screw
18368	3714	" " " " " Plate.....
934j	3714	" " " " " Screw.....
1654c	3701	" " Nut.....
17806	3701	" " Position Stud.....
63796	7216	" " Ring.....
1195e	3701	" " Screw Stud.....
8505	20333	" " " Rivet.....
39361	3758	" Regulator with 1953.....
17744	3715	" " Hinge Stud.....
18488	3759	" " Post.....
18489	3759	" " " Guide.....
810d	3759	" " " " Cap Screw...
1953	3715	" " Roller and Screw Stud with 1655c and 14017.....
1655c	3715	Feed Regulator Roller and Screw Stud Nut.....
14017	3715	Feed Regulator Roller and Screw Stud Nut Washer.....
39313	3759	Feed Regulator Swivel.....
1191d	3715	" " Thumb Screw.....
17807	3717	Knife (needle thread).....
17808	3717	" (shuttle thread).....
*63806	—	" Bar.....
63807	—	" " 63806 with 63808, 63809 and two 17814.....
39299	3752	Knife Bar 63807 with 704c and 39300....
17810	3700	" " Cap (back).....

NO.	PLATE	NAME
690j	3748	Knife Bar Cap (back) Screw.....
17811	3700	" " " (front).....
160j	3714	" " " " Screw.....
39262	3754	" " " (intermediate).....
39263	—	" " " " 39262 with 1323e, 1517e, 39264 and 39265.....
690j	3748	Knife Bar Cap (intermediate) Screw.....
39264	3754	" " " " Stop Pin
1323e	3754	" " " " " " "
		Screw Bushing.....
1517e	3754	Knife Bar Cap (intermediate) Stop Pin Screw Bushing Nut.....
39265	3754	Knife Bar Cap (intermediate) Stop Pin Spring.....
63808	7206	Knife Bar Connection.....
17814	3700	" " " Rivet.....
17915	3700	" " " Slide Block.....
63809	—	" " " " " 17915 with 63810.....
63810	7206	Knife Bar Connection Slide Block Stud...
39297	3753	" " Driving Lever with 190j, 1420e 17919 and 39298.....
1382f	3753	Knife Bar Driving Lever Hinge Screw....
1681c	3753	" " " " " " Nut
39298	3753	" " " " Lock Stud.....
17919	3700	" " " " " " Spring
190j	3710	" " " " " " "
		Screw.....
1420e	3753	Knife Bar Driving Lever Lock Stud Stop Screw.....
17820	3716	Knife Bar Extension.....
17750	—	" " " 17820 with 17821 and two 17822.....
190j	3710	Knife Bar Extension Screw.....
7071	3746	" " " " Washer.....
17821	3717	" " Rack.....
17822	3717	" " " Rivet.....
39300	3754	" " Stop Block.....
19793	3746	" " " Dowel Pin.....
704c	3754	" " " " Screw.....
39235	3758	" Cam Lever Body.....
39409	—	" " " " 39235 with 39460
39329	3758	Knife Cam Lever complete, Nos. 19793 and 39409.....
39332	3758	Knife Cam Lever Bracket with 1177j.....
8589	3722	" " " " Dowel Pin.....
1177j	3710	" " " " Screw.....

NO.	PLATE	NAME
50029c	3759	Knife Cam Lever Hinge Screw.....
18471	3759	" " " " " Bushing
18472	—	" " " " " "
		18471 with 50029c.....
1177j	3710	Knife Cam Lever Hinge Screw Bushing Clamping Screw.....
1980	3759	Knife Cam Lever Roller and Screw Stud with 1654c.....
1654c	3701	Knife Cam Lever Roller and Screw Stud Nut.....
39330	3759	Knife Cam Lever Slide with 1980.....
39460	—	" " " " 39330 with 1255j and 39331.....
1255j	3726	Knife Cam Lever Slide Screw.....
39331	3759	" " " " " Washer....
19793	3746	" " " " " Steady Pin.....
68710	—	" Holder.....
39269	3755	" " 68710 with 1336c, 17826, 17830 and two 7298.....
*39488	—	Knife Holder 39269 with 1198c, 17807, 17808 and 17829.....
17826	3717	Knife Holder Pinion.....
7298	3717	" " " " Dowel Pin.....
17827	3717	" " " " Stud.....
39270	3755	" " " " " Bracket with 17827.....
50018f	3753	Knife Holder Pinion Stud Bracket Screw
1698e	3753	" " " " " " "
		Nut.....
1198c	3717	Knife Screw.....
17829	3717	" Thread Holder.....
17830	3717	" " " " Position Pin.....
39291	3756	" " " " Retainer with 39277 and two 39278.....
39277	3755	Knife Thread Retainer Finger.....
39278	3755	" " " " " Rivet.....
1336c	3755	" " " " " Screw Stud.....
63776	7211	Needle Bar (hollow).....
63785	—	Needle Bar complete, Nos. 706D, 63776 and 63782 to 63784.....
*39203	3718	Needle Bar Connecting Link.....
63756	—	" " " " " 39203 with 21629.....
377c	3718	Needle Bar Connecting Link Hinge Screw
1518e	3718	" " " " " " "
		Nut.....
21629	3718	Needle Bar Connecting Stud with 155c...

NO.	PLATE	NAME
155c	3718	Needle Bar Connecting Stud Set Screw...
39350	3743	" " Thread Nipper Driving Lever (adjustable) with 39351 and two 335j...
39351	3759	Needle Bar Thread Nipper Driving Lever Extension.....
335j	3759	Needle Bar Thread Nipper Driving Lever Extension Screw.....
1196c	3721	Needle Bar Thread Nipper Driving Lever Hinge Screw.....
39352	3743	Needle Bar Thread Nipper Driving Lever Spring.....
63792	7211	Needle Bar Thread Nipper Lever with 17835.....
17835	3718	Needle Bar Thread Nipper Lever Bushing
1200D	3718	" " " " " Hinge Screw.....
63793	7215	Needle Bar Thread Nipper Lever Spring
1329j	3754	" " " " " " "
		Screw.....
17837	3716	Needle Bar Thread Nipper Rod.....
17838	3718	" " " " " " Adjusting Stud.....
1651E	3701	Needle Bar Thread Nipper Rod Adjusting Stud Lock Nut.....
17839	3718	Needle Bar Thread Nipper Rod Arm with 196f.....
196f	3718	Needle Bar Thread Nipper Rod Arm Set Screw.....
17840	3716	Needle Bar Thread Nipper Rod Support
190j	3710	" " " " " " "
		Screw.....
63782	7215	Needle Clamp with 237f.....
237f	3724	" Set Screw.....
63783	7215	" Stripper.....
706D	7215	" " Screw.....
63784	7215	" " Spring.....
4304	3711	Oscillating Rock Shaft with 4784.....
3052	3711	" " " " Hinge Pin.....
1513j	3724	" " " " " Nut....
635c	3724	" " " " " " Screw
		Bearing.....
1513j	3724	Oscillating Rock Shaft Hinge Pin Screw Bearing Nut.....
4784	3702	Oscillating Rock Shaft Oil Pad.....
3053	3716	" Shaft.....
*15160	—	" " Crank for 15161.....
15425	—	" " " " 15162.....

NO.	PLATE	NAME
*15161	—	Oscillating Shaft Crank complete, Nos. 462c, 1519e, 15160 and 15171.....
15162	3702	Oscillating Shaft Crank complete, Nos. 1519e, 15171, 15425 and two 462c.....
2049	3702	Oscillating Shaft Crank Pin.....
462c	3702	" " " Set Screw.....
15170	3702	" " " Slide Block.....
226j	7215	" " " " " C a p Screw.....
12424	3702	Oscillating Shaft Crank Slide Block Cap Screw Washer.....
1035c	3702	Oscillating Shaft Crank Slide Block Screw Stud.....
1519e	3702	Oscillating Shaft Crank Slide Block Screw Stud Nut.....
15171	3702	Oscillating Shaft Crank Slide Block com- plete, Nos. 226j, 1035c, 12424 and 15170
2058	3716	Presser Bar.....
17841	3718	" " Collar with two 196f.....
196f	3718	" " " Set Screw.....
17842	3718	" " Guide Bracket with 453c.....
453c	3715	" " " Set Screw.....
17843	3711	" " Lifting Lever.....
17844	3711	" " " Bracket.....
164e	3724	" " " " " Screw.....
1201c	3700	" " " Hinge Screw.....
17845	3716	" " " Rod.....
17846	—	" " " Chain.....
32675	20333	" " Spring.....
68712	20340	Pulley (loose) 2 3/4 in. diam., with 200584d.....
68713	—	" " 68712 with 68714.....
68714	20340	" " Ball Bearing.....
68715	20339	" " Bushing.....
51387r	20339	" " Cap Screw.....
200584d	20339	" " Oil Plug Screw.....
68716	20340	" (tight) 2 3/8 in. diam.....
68720	—	" " 68716 with 1206c and 17854
2022	3722	" " Pin.....
68717	—	Pulleys (ball bearing) complete, Nos. 51387r, 68713, 68715 and 68720.....
2073	3702	Shuttle Bobbin.....
2211	3702	" " Retaining Spring.....
2212	3702	" " " Rivet.....
*39295	—	" Body with 398e, 2082, 2084, 2211 and two 2212.....
*2075	—	Shuttle Cover.....
*44001	—	" " 2075 with 112e, 466h, 2078, 2080, 2086, and 2090.....
2076	3702	Shuttle Cover Hinge Pin.....
2078	3702	" Delivery Eye Thread Guard.....

NO.	PLATE	NAME
2080	3702	Shuttle Delivery Eye Thread Guard Rivet
2082	3702	" Main Spring.....
398e	3702	" " " Screw.....
2084	3702	" " " Steady Pin.....
466h	3702	" Tension Regulating Screw.....
2086	3702	" " Spring.....
2090	3702	" " " Plate.....
112e	3702	" " " Screw.....
39296	3702	Shuttle complete, Nos. 2073, 2076, 39295 and 44001.....
39487	3702	Shuttle Driver with two 457c.....
39209	3746	" " " 662d, 39210 and two 457c, for purl stitch.....
2049	3702	Shuttle Driver Pin.....
457c	3702	" " Set Screw.....
39210	3746	" " Thread Pull-off, for purl stitch.....
662d	3746	Shuttle Driver Thread Pull-off Screw.....
17746	3719	" Race Back with 17747.....
190c	3710	" " " Screw.....
17747	3719	" " " Thread Guard Pin.....
63814	—	" " Body.....
63815	3719	Shuttle Race complete, Nos. 17746, 63814 and two 190c.....
158e	3724	Shuttle Race Screw.....
17853	3720	Starting Lever.....
1262c	3726	" " Hinge Screw.....
1662c	3726	" " " " Nut.....
17886	3716	" " Pitman.....
17854	3721	Stop Cam.....
17855	3721	" " Interlocking Rod.....
63977	7236	" " " " Case.....
63978	—	" " " " " 63977 with 18443 and two 193r.....
63993	—	Stop Cam Interlocking Rod Case 63978 with 63976 and two 1255j.....
*39405	—	Stop Cam Interlocking Rod Case 63993 with 1318d, 17855, 17863, 17864 and 39222.....
39346	3760	Stop Cam Interlocking Rod Case Bracket
63754	—	Stop Cam Interlocking Rod Case Bracket complete, Nos. 1182e, 1196c, 1204e, 1254c, 1262c, 1508e, 1662c, 17853, 17859, 17861, 17862, 17872, 17873, 39346, 39405 and two 898d.....
39347	—	Stop Cam Interlocking Rod Case Bracket 63754 with 39343, 39344 and two 1186j

**LIST OF PARTS COMPLETE
FOR**

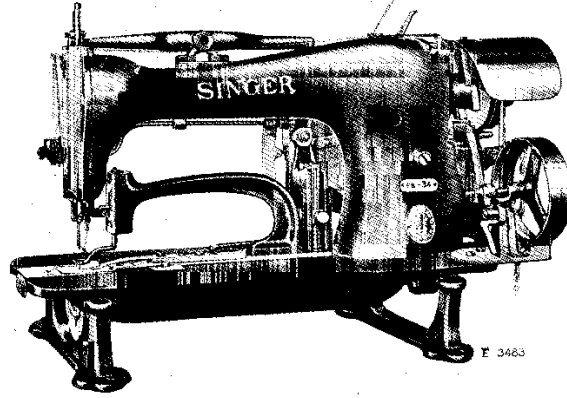

MACHINE No. 68-34

OBSOLETE USE 68-38 MACHINE

**FOR BARRING BUTTONHOLES IN CLOTHING. MAKES BAR
1/8 INCH TO 1/4 INCH LONG, CONSISTING OF SEVEN STAYING,
ELEVEN COVERING AND THREE TYING STITCHES. THE
MACHINE IS FITTED WITH AN AUTOMATIC BAR LOCATING
DEVICE.**

NO.	PLATE	NAME
63817	7218	Arch Clamp Foot with 17959.....
17708	3710	" " " Lifter with 17866.....
190J	3710	" " " " Screw.....
17959	3731	" " " Lifting Stud.....
63818	7218	" " " Plate.....
217J	3731	" " " " Screw.....
63836	7218	" " " Spring.....
217J	3731	" " " " Screw (lower)...
1190c	3715	" " " " " (upper)...

PARTS FOR MACHINE No. 68-34 91

NO.	PLATE	NAME
63819	7209	Arch Clamp Frame.....
14079	3731	" " " Dowel Pin.....
181J	3738	" " " Screw.....
63820	—	Arch Clamp complete, Nos. 405J, 1190c, 63817 to 63819, 63825, 63831, 63833, 63836, two each 181J, 1186c, 1651J, 14079, 17803 and five 217J.....
*39279	—	Arm with 4449, 15404, 17844 and two each 164E and 15405.....
2002	3722	Arm Dowel Pin.....
4448	3722	" Oil Tube for intermediate bearing....
880E	3724	" Screw.....
17702	3728	" Shaft.....
17703	3711	" " Bushing (back).....
50333c	3788	" " " " Adjusting Screw.....
1520E	3724	Arm Shaft Bushing (back) Adjusting Screw Nut.....
*4449	—	Arm Shaft Bushing (front).....
63821	7216	Bar Locating Finger.....
63822	7216	" " " Holder.....
63823	7216	" " " " Extension
236J	3705	" " " " " " Screw.....
63824	7218	Bar Locating Finger Holder Extension Spring.....
63825	7218	Bar Locating Finger Holder Extension Spring Stud.....
50130J	7218	Bar Locating Finger Holder Screw.....
217J	3731	" " " " Screw.....
7071	3746	" " " " Washer.....
63826	7216	" " " " Tripping Lever with 63828.....
63827	7218	Bar Locating Finger Tripping Lever Hinge Screw Stud.....
199D	7218	Bar Locating Finger Tripping Lever Hinge Screw Stud Cap Screw.....
63828	7216	Bar Locating Finger Tripping Lever Sleeve.....
63829	7218	Bar Locating Finger Tripping Lever Stud
*17704	—	Bed.....
18498	7202	Belt Cover.....
39290	3743	" " Bracket with 184E and 17741.
184E	3753	" " " " Screw Stud.....
17741	3701	" " " " Stud.....
217J	3731	" " " " Screw.....
39222	3725	" Shifter.....

NO.	PLATE	NAME
63976	7235	Belt Shifter Clamp.....
1255J	3726	" " " Screw.....
4292	3711	Crank Connecting Rod with two 145E....
145E	3726	" " " Cap Screw.....
375c	3724	" " " Hinge Screw.....
1518E	3718	" " " " " Nut.....
17724	3711	Face Plate.....
*63736	—	" " 17724 with 2105.....
17725	—	Face Plate complete, Nos. 448c, 2107, 2127, 56791, 63736 and two 233J.....
164J	3724	Face Plate Screw.....
2107	3722	" " Thread Guard.....
233J	3722	" " " " Screw.....
17726	3714	Feed Across Connection Adjusting Stud
1649c	3714	" " " " " "
		Nut (left).....
1650c	3714	Feed Across Connection Adjusting Stud Nut (right).....
896E	7235	Feed Across Connection Cap Screw.....
63940	7235	" " " (lever end) with two 896E.....
63941	—	Feed Across Connection (lever end) 63940 with 55381.....
55381	7235	Feed Across Connection (lever end) Ball Stud.....
1185c	3714	Feed Across Connection (lever end) Ball Stud Set Screw.....
63942	7235	Feed Across Connection (regulator end) with two 896E.....
63943	—	Feed Across Connection (regulator end) 63942 with 63944.....
63944	7235	Feed Across Connection (regulator end) Ball Stud.....
17729	3713	Feed Across Lever with 1185c and 1952...
17731	3713	" " " Bracket with 17732 and three 160J.....
*17732	—	Feed Across Lever Bracket Cap.....
160J	3714	" " " " " Screw.....
8589	3722	" " " " Dowel Pin....
1177J	3710	" " " " Screw.....
17737	3714	" " " Hinge Stud.....
160J	3714	" " " " Clamping Screw.....
1952	3714	Feed Across Lever Roller and Stud.....
17735	3701	" " Plate with 17741.....
1186c	3701	" " " Screw.....
1651J	3701	" " " " Nut.....

NO.	PLATE	NAME
17736	3713	Feed Across Regulator.....
50599D	7235	" " " Adjusting Screw Stud.....
1676c	3746	Feed Across Regulator Adjusting Screw Stud Nut.....
46244	7235	Feed Across Regulator Adjusting Screw Stud Nut Washer (fibre).....
17738	3715	Feed Across Regulator Adjusting Screw Stud Nut Washer (steel).....
1188D	3724	Feed Across Regulator Hinge Screw.....
17740	3715	" " " Link.....
1189E	3715	" " " " Screw Stud..
17741	3701	" " " " Stud.....
63830	—	" Cam with two each 1192c, 17874, 63829 and four 190J.....
18415	3746	Feed Cam Driving Worm with 1441c and 1442c.....
1442c	3746	Feed Cam Driving Worm Position Screw.
1441c	3746	" " " " Set Screw.....
17797	3713	" " " " Wheel with 453c
18384	3753	" " " " " Pin.....
453c	3715	" " " " " Set Screw
18384	3753	" " Pin.....
1192c	3724	" " Set Screw.....
18416	3712	" " Shaft.....
18417	3712	" " " Bracket.....
1177J	3710	" " " " Screw (back)...
1193J	3724	" " " " " (front)...
1653c	3724	" " " Nut.....
63831	7210	" Plate.....
*63832	7212	" " Carrier Bar.....
63833	—	" " " " 63832 with 934J, 17743, 17802, 17804, 18390, two 7476 and four 17806.....
17802	3701	Feed Plate Carrier Bar Block.....
17803	3701	" " " " " Cover.....
17804	3701	" " " " " Rivet.....
7476	3701	" " " " " Steady Pin.
17805	3714	" " " " " Pivot Block.....
1194D	3714	" " " " " " Screw
18390	7214	" " " " " Plate.....
934J	3714	" " " " " Screw.....
17806	3701	" " Position Stud.....
405J	7214	" " Screw.....
17742	3713	" Regulator with 1953.....
17744	3715	" " Hinge Stud.....
17743	3715	" " Post.....

NO.	PLATE	NAME
1953	3715	Feed Regulator Roller and Screw Stud with 1655c and 14017.....
1655c	3715	Feed Regulator Roller and Screw Stud Nut.....
14017	3715	Feed Regulator Roller and Screw Stud Nut Washer.....
1190c	3715	Feed Regulator Stop Screw.....
17745	3715	" " Swivel.....
1191D	3715	" " Thumb Screw.....
17807	3717	Knife (needle thread).....
17808	3717	" (shuttle thread).....
*63806	—	" Bar.....
63807	—	" " 63806 with 63808, 63809 and two 17814.....
39299	3752	Knife Bar 63807 with 704c and 39300....
17810	3700	" " Cap (back).....
690J	3748	" " " " Screw.....
17811	3700	" " " (front).....
160J	3714	" " " " Screw.....
39262	3754	" " " (intermediate).....
39263	—	" " " " 39262 with 1328E, 1517E, 39264 and 39265.....
690J	3748	Knife Bar Cap (intermediate) Screw.....
39264	3754	" " " " Stop Pin
1328E	3754	" " " " " " Screw Bushing.....
1517E	3754	Knife Bar Cap (intermediate) Stop Pin Screw Bushing Nut.....
39265	3754	Knife Bar Cap (intermediate) Stop Pin Spring.....
63808	7206	Knife Bar Connection.....
17814	3700	" " " " Rivet.....
17915	3700	" " " " Slide Block.....
63809	—	" " " " " " 17915 with 63810.....
63810	7206	Knife Bar Connection Slide Block Stud...
39297	3753	" " Driving Lever with 190J, 1420E, 17919 and 39298.....
1382F	3753	Knife Bar Driving Lever Hinge Screw....
1681c	3753	" " " " " " Nut
39298	3753	" " " " " Lock Stud.....
17919	3700	" " " " " " Spring
190J	3710	" " " " " " " Screw.....
1420E	3753	Knife Bar Driving Lever Lock Stud Stop Screw.....

NO.	PLATE	NAME
17820	3716	Knife Bar Extension.....
17750	—	" " " " 17820 with 17821 and two 17822.....
190J	3710	Knife Bar Extension Screw.....
7071	3746	" " " " Washer.....
17821	3717	" " Rack.....
17822	3717	" " " Rivet.....
39300	3754	" " Stop Block.....
19793	3746	" " " Dowel Pin.....
704c	3754	" " " Screw.....
39235	3758	" Cam Lever Body.....
39409	—	" " " " 39235 with 39460.
39329	3758	Knife Cam Lever complete, Nos. 19793 and 39409.....
39332	3758	Knife Cam Lever Bracket with 1177J....
8589	3722	" " " " Dowel Pin.....
1177J	3710	" " " " Screw.....
50029c	3759	" " " Hinge Screw.....
18471	3759	" " " " Bushing
18472	—	" " " " " " 18471 with 50029c.....
1177J	3710	Knife Cam Lever Hinge Screw Bushing Clamping Screw.....
1980	3759	Knife Cam Lever Roller and Screw Stud with 1654c.....
1654c	3701	Knife Cam Lever Roller and Screw Stud Nut.....
39330	3759	Knife Cam Lever Slide with 1980.....
39460	—	" " " " 39330 with 1255J and 39331.....
1255J	3726	Knife Cam Lever Slide Screw.....
39331	3759	" " " " " Washer....
19793	3746	" " " " Steady Pin.....
68710	—	" Holder.....
39269	3755	" " 68710 with 1336c, 17826, 17830 and two 7298.....
*39488	—	Knife Holder 39269 with 1198c, 17807, 17808 and 17829.....
17826	3717	Knife Holder Pinion.....
7298	3717	" " " Dowel Pin.....
17827	3717	" " " Stud.....
39270	3755	" " " " Bracket with 17827.....
50018F	3753	Knife Holder Pinion Stud Bracket Screw
1698E	3753	" " " " " " Nut.....
1198c	3717	Knife Screw.....

NO.	PLATE	NAME
17829	3717	Knife Thread Holder.....
17830	3717	" " " Position Pin.....
39291	3756	" " Retainer with 39277 and two 39278.....
39277	3755	Knife Thread Retainer Finger.....
39278	3755	" " " Rivet.....
1336c	3755	" " " Screw Stud.....
17831	3716	Needle Bar with 237F.....
*39203	3718	" " Connecting Link.....
63756	—	" " " " 39203 with 21629.....
377c	3718	Needle Bar Connecting Link Hinge Screw
1518E	3718	" " " " " "
		Nut.....
21629	3718	Needle Bar Connecting Stud with 155c...
155c	3718	" " " " Set Screw...
39350	3743	" " Thread Nipper Driving Lever (adjustable) with 39351 and two 335r..
39351	3759	Needle Bar Thread Nipper Driving Lever Extension.....
335J	3759	Needle Bar Thread Nipper Driving Lever Extension Screw.....
1196c	3721	Needle Bar Thread Nipper Driving Lever Hinge Screw.....
39352	3743	Needle Bar Thread Nipper Driving Lever Spring.....
17834	3718	Needle Bar Thread Nipper Lever with 17835.....
17835	3718	Needle Bar Thread Nipper Lever Bushing
1200D	3718	" " " " " Hinge Screw.....
39276	3754	Needle Bar Thread Nipper Lever Spring
1329D	3754	" " " " " " Screw.....
17837	3716	Needle Bar Thread Nipper Rod.....
17838	3718	" " " " " Adjusting Stud.....
1651E	3701	Needle Bar Thread Nipper Rod Adjusting Stud Lock Nut.....
17839	3718	Needle Bar Thread Nipper Rod Arm with 196F.....
196F	3718	Needle Bar Thread Nipper Rod Arm Set Screw.....
17840	3716	Needle Bar Thread Nipper Rod Support
190J	3710	" " " " " " Screw.....
237F	3724	Needle Set Screw.....

NO.	PLATE	NAME
4304	3711	Oscillating Rock Shaft with 4784.....
3052	3711	" " " Hinge Pin.....
1513J	3724	" " " " " Nut....
635c	3724	" " " " " Screw Bearing.....
1513J	3724	Oscillating Rock Shaft Hinge Pin Screw Bearing Nut.....
4784	3702	Oscillating Rock Shaft Oil Pad.....
3053	3716	" Shaft.....
*15160	—	" " Crank for 15161.....
15425	—	" " " " 15162.....
*15161	—	Oscillating Shaft Crank complete, Nos. 462c, 1519E, 15160 and 15171.....
15162	3702	Oscillating Shaft Crank complete, Nos. 1519E, 15171, 15425 and two 462c.....
2049	3702	Oscillating Shaft Crank Pin.....
462c	3702	" " " Set Screw.....
15170	3702	" " " Slide Block.....
226J	7215	" " " " " C a p Screw.....
12424	3702	Oscillating Shaft Crank Slide Block Cap Screw Washer.....
1035c	3702	Oscillating Shaft Crank Slide Block Screw Stud.....
1519E	3702	Oscillating Shaft Crank Slide Block Screw Stud Nut.....
15171	3702	Oscillating Shaft Crank Slide Block com- plete, Nos. 226J, 1035c, 12424 and 15170
2058	3716	Presser Bar.....
17841	3718	" " Collar with two 196F.....
196F	3718	" " " Set Screw.....
17842	3718	" " Guide Bracket with 453c.....
453c	3715	" " " Set Screw.....
17843	3711	" " Lifting Lever.....
17844	3711	" " " Bracket.....
164E	3724	" " " " " Screw..
1201c	3700	" " " " Hinge Screw...
17845	3716	" " " " Rod.....
17846	—	" " " " Chain.....
32675	20333	" " Spring.....
68712	20340	Pulley (loose) 2 $\frac{1}{4}$ in. diam., with 200584D.
68713	—	" " 68712 with 68714.....
68714	20340	" " Ball Bearing.....
68715	20339	" " Bushing.....
51387A	20339	" " Cap Screw.....
200584D	20339	" " Oil Plug Screw.....
68716	20340	" (tight) 2 $\frac{1}{4}$ in. diam.....
68720	—	" " 68716 with 1206c and 17854
2022	3722	" " Pin.....

NO.	PLATE	NAME
68717	—	Pulleys (ball bearing) complete, Nos. 51387R, 68713, 68715 and 68720.....
2073	3702	Shuttle Bobbin.....
2211	3702	" " Retaining Spring.....
2212	3702	" " " " Rivet.....
*39295	—	" Body with 398E, 2082, 2084, 2211 and two 2212.....
*2075	—	Shuttle Cover.....
*44001	—	" " 2075 with 112E, 466H, 2078, 2080, 2086 and 2090.....
2076	3702	Shuttle Cover Hinge Pin.....
2078	3702	" Delivery Eye Thread Guard.....
2080	3702	" " " " Rivet.....
2082	3702	" Main Spring.....
398E	3702	" " " Screw.....
2084	3702	" " " Steady Pin.....
466H	3702	" Tension Regulating Screw.....
2086	3702	" " Spring.....
2090	3702	" " " Plate.....
112E	3702	" " " Screw.....
39296	3702	Shuttle complete, Nos. 2073, 2076, 39295 and 44001.....
39487	3702	Shuttle Driver with two 457c.....
39209	3746	" " " 662D, 39210 and two 457c, for purl stitch.....
2049	3702	Shuttle Driver Pin.....
457c	3702	" " Set Screw.....
39210	3746	" " Thread Pull-off, for purl stitch.....
662D	3746	Shuttle Driver Pull-off Screw.....
17746	3719	" Race Back with 17747.....
190c	3710	" " " Screw.....
17747	3719	" " " Thread Guard Pin.....
63814	—	" " Body.....
63815	3719	Shuttle Race complete, Nos. 17746, 63814 and two 190c.....
158E	3724	Shuttle Race Screw.....
17853	3720	Starting Lever.....
1262c	3726	" " Hinge Screw.....
1662c	3726	" " " " Nut.....
17886	3716	" " Pitman.....
17854	3721	Stop Cam.....
17855	3721	" " Interlocking Rod.....
63977	7236	" " " " Case.....
63978	—	" " " " " 63977 with 18443 and two 193r.....

NO.	PLATE	NAME
63993	—	Stop Cam Interlocking Rod Case 63978 with 63976 and two 1255j.....
*39405	—	Stop Cam Interlocking Rod Case 63993 with 1318D, 17855, 17863, 17864 and 39222.....
39346	3760	Stop Cam Interlocking Rod Case Bracket
63754	—	Stop Cam Interlocking Rod Case Bracket complete, Nos. 1182E, 1196c, 1204E, 1254c, 1262c, 1508E, 1662c, 17853, 17859, 17861, 17862, 17872, 17873, 39346, 39405 and two 898D.....
39347	—	Stop Cam Interlocking Rod Case Bracket 63754 with 39343, 39344 and two 1186j
16532	3722	Stop Cam Interlocking Rod Case Bracket Dowel Pin.....
1343E	3753	Stop Cam Interlocking Rod Case Bracket Screw.....
1204E	3721	Stop Cam Interlocking Rod Case Hinge Screw.....
17859	3720	Stop Cam Interlocking Rod Case Socket Joint.....
898D	3721	Stop Cam Interlocking Rod Case Socket Joint Cap Screw.....
39343	3760	Stop Cam Interlocking Rod Case Spring (flat).....
50682c	7235	Stop Cam Interlocking Rod Case Spring Adjusting Screw.....
1520E	3759	Stop Cam Interlocking Rod Case Spring Adjusting Screw Nut.....
39344	3759	Stop Cam Interlocking Rod Case Spring Bracket with 1520E and 50682c.....
1186j	3701	Stop Cam Interlocking Rod Case Spring Bracket Screw.....
17861	3721	Stop Case Interlocking Rod Case Stop Stud.....
1254c	3726	Stop Cam Interlocking Rod Case Stop Stud Screw Bushing.....
1508E	3726	Stop Cam Interlocking Rod Case Stop Stud Screw Bushing Lock Nut.....
17862	3721	Stop Cam Interlocking Rod Case Stop Stud Spring.....
18443	3754	Stop Cam Interlocking Rod Case Wearing Block.....
193j	3754	Stop Cam Interlocking Rod Case Wearing Block Screw.....

100 PARTS FOR MACHINE No. 68-34

NO.	PLATE	NAME
17863	3721	Stop Cam Interlocking Rod Spring.....
17864	3721	" " " " Stop.....
1318D	3748	" " " " " Screw..
3012	3722	" " Pin.....
1200c	3721	" " Screw.....
2102	3722	Tension Disc.....
1560c	3722	" Regulating Thumb Nut.....
600c	3722	" Screw Stud.....
16202	—	" " " 600c and 1560c.....
448c	3722	" " " Set Screw.....
2103	3722	" Spring.....
2105	3722	" Thread Guard.....
56791	—	Tension complete, Nos. 2103, 2124, 16202 and two 2102.....
*63749	—	Thread Take-up Cam.....
39204	3711	" " " 63749 with 446c....
3012	3722	" " " Pin.....
446c	3724	" " " Set Screw.....
*3072	3711	" " Lever with 1819.....
56855	—	" " " 3072 with 1088c....
1088c	7213	" " " Hinge Screw.....
1819	3724	" " " Roller and Stud...
2124	3722	" " Spring.....
2127	3722	" " " Regulator Plate
233J	3722	" " " " " "
		Adjusting Screw.....
17865	3710	Thread Wiper Body.....
1207D	3710	" " " Hinge Screw.....
17866	3710	" " " Hook.....
17867	3710	" " " Support.....
641c	3726	" " " " Set Screw...
17868	3710	" " " Wire.....
337J	3718	" " " " Screw.....
17869	3710	" " " " Washer..
63997	—	Throat Plate Body.....
39292	3756	" " " 63997 with 17749, 17871 and two each 1208D and 50406D.....
39293	—	Throat Plate 63997 with 17749, 17924 and two each 1208D and 50406D.....
39406	—	Throat Plate 39292 with 1698E, 39270, 39291, 39488 and 50018r.....
39475	—	Throat Plate 39293 with 1698E, 39270, 39291, 39488 and 50018r.....
17749	3723	Throat Plate Extension.....
50406D	7213	" " " Screw.....
17871	3723	" " " Needle Hole Bushing for 39292.....

PARTS FOR MACHINE No. 68-34 101

NO.	PLATE	NAME
17924	3723	Throat Plate Needle Hole Bushing for 39293.....
1208D	3723	Throat Plate Needle Hole Bushing Screw.
691F	3724	" " Screw.....
17872	3721	Trip Lever.....
1196c	3721	" " Hinge Screw.....
17873	3721	" " Spring.....
1182E	3705	" " " " Screw.....
17874	3717	Tripping Point.....
190J	3710	" " Screw.....
*15404	—	Trade Mark.....
15405	20333	" " Rivet.....

Genuine "SINGER" Needles should be used
in "SINGER" Machines.
These Needles and their Containers
are marked with the
Company's Trade Mark "SIMANCO" 1

Needles in Containers marked
"FOR SINGER MACHINES"
are NOT "SINGER" made needles. 2

From the library of: Diamond Needle Corp

**LIST OF PARTS COMPLETE
FOR**

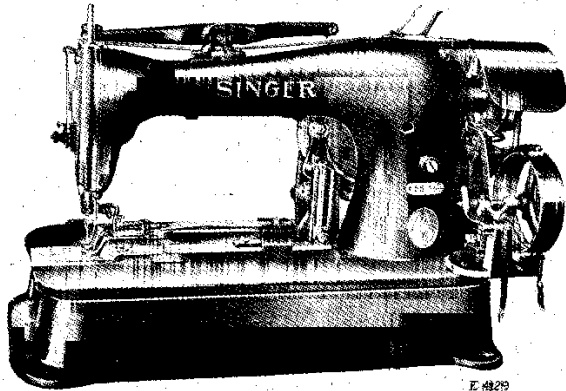

MACHINE No. 68-36

**FOR SEWING HOOKS ON LADIES' BELTS IN TWO TACKS.
MAKES EIGHT CROSS STITCHES, TWELVE STITCHES IN
EACH PARALLEL BAR AND THREE TYING STITCHES.**

NO.	PLATE	NAME
*63989	—	Arm with 4449, 15404, 17844 and two each 164E and 15405.....
2002	3722	Arm Dowel Pin.....
4448	3722	" Oil Tube for intermediate bearing...
880E	3724	" Screw.....
17702	3728	" Shaft.....
17703	3711	" " Bushing (back).....
50333c	3788	" " " " Adjusting Screw.....
1520E	3724	Arm Shaft Bushing (back) Adjusting Screw Nut.....
*4449	—	Arm Shaft Bushing (front).....
124674	20334	" Side Cover.....
190J	3710	" " " Screw.....
*17704	—	Bed.....
18498	7202	Belt Cover.....

NO.	PLATE	NAME
39290	3743	Belt Cover Bracket with 184E and 17741.
184E	3753	" " " Screw Stud.....
17741	3701	" " " Stud.....
217J	3731	" " Screw.....
39222	3725	" Shifter.....
63976	7235	" " Clamp.....
1255J	3726	" " " Screw.....
63933	7237	Clamp (left) with 9311 and 17723.....
63934	7237	" (right) with 9311 and 17723.....
63935	7237	" Arm with 17714 and 63788.....
17710	3704	" " Hinge Plate.....
1176J	3704	" " " " Screw.....
63788	7205	" " Hook.....
1175J	3704	" Hinge Screw.....
17708	3710	" Lifter with 17866.....
190J	3710	" " Screw.....
17712	3710	" Pressure Spring.....
17713	3710	" " " Bracket.....
1177J	3710	" " " " Screw.....
17714	3704	" " " Guide Block.....
1178J	3710	" " " " Screw.....
20437	20333	" " " " Washer.....
17716	3705	" Spreader.....
39318	3757	" " Holder with two 17720...
1183J	3705	" " " " Screw.....
17717	3705	" " Lever.....
50237K	3705	" " " Hinge Screw.....
1180J	3705	" " " " Locking Thumb Screw.....
17718	3705	Clamp Spreader Lever Locking Thumb Screw Washer.....
1182J	3705	Clamp Spreader Screw.....
17719	3705	" " " Spring.....
1181J	3705	" " " " Screw.....
17720	3705	" " " Steady Pin.....
63936	7237	" Spring (left).....
63937	7237	" " (right).....
240J	7237	" " " Screw.....
9311	3747	" " " Steady Pin.....
63938	7239	" Stop.....
1180J	3705	" " " Thumb Screw.....
17718	3705	" " " " Washer.....
17723	3704	" Stud.....
63930	—	Clamp complete, Nos. 1181J, 1182J, 1183J, 17716, 17717, 17719, 39318, 50237K, 63933 to 63938 and two each 240J, 1175J, 1180J and 17718.....

NO.	PLATE	NAME
4292	3711	Crank Connecting Rod with two 145E....
145E	3726	" " " Cap Screw.....
375c	3724	" " " Hinge Screw.....
1518E	3718	" " " " " Nut
17724	3711	Face Plate.....
*63736	—	" " 17724 with 2105.....
17725	—	Face Plate complete, Nos. 448c, 2107, 2127, 56791, 63736 and two 233J.....
164J	3724	Face Plate Screw.....
2107	3722	" " Thread Guard.....
233J	3722	" " " " Screw.....
17726	3714	Feed Across Connection Adjusting Stud
1649c	3714	" " " " " "
		Nut (left).....
1650c	3714	Feed Across Connection Adjusting Stud Nut (right).....
896E	7235	Feed Across Connection Cap Screw.....
63940	7235	" " " (lever end) with two 896E.....
63941	—	Feed Across Connection (lever end) 63940 with 55381.....
55381	7235	Feed Across Connection (lever end) Ball Stud.....
1185c	3714	Feed Across Connection (lever end) Ball Stud Set Screw.....
63942	7235	Feed Across Connection (regulator end) with two 896E.....
63943	—	Feed Across Connection (regulator end) 63942 with 63944.....
63944	7235	Feed Across Connection (regulator end) Ball Stud.....
17729	3713	Feed Across Lever with 1185c and 1952...
17731	3713	" " " Bracket with 17732 and three 160J.....
*17732	—	Feed Across Lever Bracket Cap.....
160J	3714	" " " " " Screw.....
8589	3722	" " " " Dowel Pin....
1177J	3710	" " " " Screw.....
17737	3714	" " " Hinge Stud.....
160J	3714	" " " " " Clamping Screw.....
1952	3714	Feed Across Lever Roller and Stud.....
17735	3701	" " Plate with 17741.....
1186c	3701	" " " Screw.....
1651J	3701	" " " Nut.....
17736	3713	" " Regulator.....

NO.	PLATE	NAME
50599D	7235	Feed Across Regulator Adjusting Screw Stud.....
1676c	3746	Feed Across Regulator Adjusting Screw Stud Nut.....
46244	7235	Feed Across Regulator Adjusting Screw Stud Nut Washer (fibre).....
17738	3715	Feed Across Regulator Adjusting Screw Stud Nut Washer (steel).....
1188D	3724	Feed Across Regulator Hinge Screw.....
17740	3715	" " " Link.....
1189E	3715	" " " " Screw Stud..
17741	3701	" " " " Stud.....
17786	—	" Cam with 17874 and two each 190J and 1192c.....
39211	3746	Feed Cam Driving Worm with 1441c and 1442c.....
1442c	3746	Feed Cam Driving Worm Position Screw..
1441c	3746	" " " " Set Screw.....
39212	3743	" " " " Wheel with 453c.....
18384	3753	Feed Cam Driving Worm Wheel Pin.....
453c	3715	" " " " " Set Screw
18384	3753	" " Pin.....
1192c	3724	" " Set Screw.....
62155	20334	" " Shaft.....
1653c	3724	" " " Nut.....
63931	7238	" Plate.....
*39259	3716	" " Carrier Bar.....
39260	—	" " " " 39259 with 934J, 1195E, 8505, 17743, 17802, 17804, 18368, two 7476 and four 17806.....
17802	3701	Feed Plate Carrier Bar Block.....
17803	3701	" " " " " Cover.....
17804	3701	" " " " " Rivet.....
7476	3701	" " " " " Steady Pin
17805	3714	" " " " " Pivot Block.....
1194D	3714	" " " " " " Screw
18368	3714	" " " " " Plate.....
934J	3714	" " " " " Screw.....
1654c	3701	" " Nut.....
17806	3701	" " Position Stud.....
1195E	3701	" " Screw Stud.....
8505	20333	" " " " Rivet.....
17742	3713	" Regulator with 1953.....
17744	3715	" " Hinge Stud.....
17743	3715	" " Post.....

106 PARTS FOR MACHINE No. 68-36

NO.	PLATE	NAME
1953	3715	Feed Regulator Roller and Screw Stud with 1655c and 14017.....
1655c	3715	Feed Regulator Roller and Screw Stud Nut.....
14017	3715	Feed Regulator Roller and Screw Stud Nut Washer.....
1190c	3715	Feed Regulator Stop Screw.....
17745	3715	" " Swivel.....
1191D	3715	" " Thumb Screw.....
17807	3717	Knife (needle thread).....
17808	3717	" (shuttle thread).....
*63806	—	" Bar.....
63807	—	" " 63806 with 63808, 63809 and two 17814.....
39299	3752	Knife Bar 63807 with 704c and 39300....
17810	3700	" " Cap (back).....
690J	3748	" " " " Screw.....
17811	3700	" " " (front).....
160J	3714	" " " " Screw.....
39262	3754	" " " (intermediate).....
39263	—	" " " " 39262 with 1328E, 1517E, 39264 and 39265.....
690J	3748	Knife Bar Cap (intermediate) Screw....
39264	3754	" " " " Stop Pin
1328E	3754	" " " " " " " " Screw Bushing.....
1517E	3754	Knife Bar Cap (intermediate) Stop Pin Screw Bushing Nut.....
39265	3754	Knife Bar Cap (intermediate) Stop Pin Spring.....
63808	7206	Knife Bar Connection.....
17814	3700	" " " Rivet.....
17915	3700	" " " Slide Block.....
63809	—	" " " " " 17915 with 63810.....
63810	7206	Knife Bar Connection Slide Block Stud...
39297	3753	" " Driving Lever with 190J, 1420E, 17919 and 39298.....
1382F	3753	Knife Bar Driving Lever Hinge Screw....
1681c	3753	" " " " " " Nut
39298	3753	" " " " Lock Stud.....
17919	3700	" " " " " " Spring
190J	3710	" " " " " " " " Screw.....
1420E	3753	Knife Bar Driving Lever Lock Stud Stop Screw.....

PARTS FOR MACHINE No. 68-36 107

NO.	PLATE	NAME
17820	3716	Knife Bar Extension.....
17750	—	" " " 17820 with 17821 and two 17822.....
190J	3710	Knife Bar Extension Screw.....
7071	3746	" " " " Washer.....
17821	3717	" " Rack.....
17822	3717	" " Rivet.....
39300	3754	" " Stop Block.....
19793	3746	" " " Dowel Pin.....
704c	3754	" " " Screw.....
39235	3758	" Cam Lever Body.....
39409	—	" " " " 39235 with 39460
39329	3758	Knife Cam Lever complete, Nos. 19793 and 39409.....
39332	3758	Knife Cam Lever Bracket with 1177J.....
8589	3722	" " " " Dowel Pin.....
1177J	3710	" " " " Screw.....
50029c	3759	" " " Hinge Screw.....
18471	3759	" " " " " Bushing
18472	—	" " " " " " " " 18471 with 50029c.....
1177J	3710	Knife Cam Lever Hinge Screw Bushing Clamping Screw.....
1980	3759	Knife Cam Lever Roller and Screw Stud with 1654c.....
1654c	3701	Knife Cam Lever Roller and Screw Stud Nut.....
39330	3759	Knife Cam Lever Slide with 1980.....
39460	—	" " " " 39330 with 1255J and 39331.....
1255J	3726	Knife Cam Lever Slide Screw.....
39331	3759	" " " " " Washer.....
19793	3746	" " " " Steady Pin.....
68710	—	" Holder.....
39269	3755	" " 68710 with 1336c, 17826, 17830 and two 7298.....
*39488	—	Knife Holder 39269 with 1198c, 17807, 17808 and 17829.....
17826	3717	Knife Holder Pinion.....
7298	3717	" " " Dowel Pin.....
17827	3717	" " " Stud.....
39270	3755	" " " " Bracket with 17827.....
50018F	3753	Knife Holder Pinion Stud Bracket Screw
1698E	3753	" " " " " " " " Nut.....
1198c	3717	Knife Screw.....

108 PARTS FOR MACHINE No. 68-36

NO.	PLATE	NAME
17829	3717	Knife Thread Holder.....
17830	3717	" " " Position Pin.....
39291	3756	" " Retainer with 39277 and two 39278.....
39277	3755	Knife Thread Retainer Finger.....
39278	3755	" " " Rivet.....
1336c	3755	" " " Screw Stud.....
17831	3716	Needle Bar with 237F.....
*39203	3718	" " Connecting Link.....
63756	—	" " " " 39203 with 21629.....
377c	3718	Needle Bar Connecting Link Hinge Screw
1518E	3718	" " " " " "
		Nut.....
21629	3718	Needle Bar Connecting Stud with 155c...
155c	3718	" " " " Set Screw...
39350	3743	" " Thread Nipper Driving Lever (adjustable) with 39351 and two 335r..
39351	3759	Needle Bar Thread Nipper Driving Lever Extension.....
335J	3759	Needle Bar Thread Nipper Driving Lever Extension Screw.....
1196c	3721	Needle Bar Thread Nipper Driving Lever Hinge Screw.....
39352	3743	Needle Bar Thread Nipper Driving Lever Spring.....
17834	3718	Needle Bar Thread Nipper Lever with 17835.....
17835	3718	Needle Bar Thread Nipper Lever Bushing
1200D	3718	" " " " " Hinge Screw.....
39276	3754	Needle Bar Thread Nipper Lever Spring
1329J	3754	" " " " " "
		Screw.....
17837	3716	Needle Bar Thread Nipper Rod.....
17838	3718	" " " " " Adjusting Stud.....
1651E	3701	Needle Bar Thread Nipper Rod Adjusting Stud Lock Nut.....
17839	3718	Needle Bar Thread Nipper Rod Arm with 196F.....
196F	3718	Needle Bar Thread Nipper Rod Arm Set Screw.....
17840	3716	Needle Bar Thread Nipper Rod Support
190J	3710	" " " " " "
		Screw.....
237F	3724	Needle Set Screw.....

PARTS FOR MACHINE No. 68-36 109

NO.	PLATE	NAME
4304	3711	Oscillating Rock Shaft with 4784.....
3052	3711	" " " Hinge Pin.....
1513J	3724	" " " " " Nut....
635c	3724	" " " " " Screw
		Bearing.....
1513J	3724	Oscillating Rock Shaft Hinge Pin Screw
		Bearing Nut.....
4784	3702	Oscillating Rock Shaft Oil Pad.....
3053	3716	" Shaft.....
*15160	—	" " Crank for 15161.....
15425	—	" " " " 15162.....
*15161	—	Oscillating Shaft Crank complete, Nos. 462c, 1519E, 15160 and 15171.....
15162	3702	Oscillating Shaft Crank complete, Nos. 1519E, 15171, 15425 and two 462c.....
2049	3702	Oscillating Shaft Crank Pin.....
462c	3702	" " " Set Screw.....
15170	3702	" " " Slide Block.....
226J	7215	" " " " " C a p Screw.....
12424	3702	Oscillating Shaft Crank Slide Block Cap Screw Washer.....
1035c	3702	Oscillating Shaft Crank Slide Block Screw Stud.....
1519E	3702	Oscillating Shaft Crank Slide Block Screw Stud Nut.....
15171	3702	Oscillating Shaft Crank Slide Block complete, Nos. 226J, 1035c, 12424 and 15170.....
2058	3716	Presser Bar.....
17841	3718	" " Collar with two 196F.....
196F	3718	" " " Set Screw.....
17842	3718	" " Guide Bracket with 453c.....
453c	3715	" " " " Set Screw....
17843	3711	" " Lifting Lever.....
17844	3711	" " " " Bracket.....
164E	3724	" " " " " Screw
1201c	3700	" " " " Hinge Screw...
17845	3716	" " " " Rod.....
17846	—	" " " " Chain.....
32675	20333	" " Spring.....
68712	20340	Pulley (loose) 2 3/4 in. diam., with 200584D.
68713	—	" " 68712 with 68714.....
68714	20340	" " Ball Bearing.....
68715	20339	" " Bushing.....
51387r	20339	" " Cap Screw.....
200584D	20339	" " Oil Plug Screw.....
68716	20340	" (tight) 2 3/8 in. diam.....
68720	—	" " 68716 with 1206c and 17854
2022	3722	" " Pin.....

110 PARTS FOR MACHINE No. 68-36

NO.	PLATE	NAME
68717	—	Pulleys (ball bearing) complete, Nos. 51387R, 68713, 68715 and 68720.....
2073	3702	Shuttle Bobbin.....
2211	3702	" " Retaining Spring.....
2212	3702	" " " " Rivet....
*39295	—	" Body with 398E, 2082, 2084, 2211 and two 2212.....
*2075	—	Shuttle Cover.....
*44001	—	" " 2075 with 112E, 466H, 2078, 2080, 2086 and 2090.....
2076	3702	Shuttle Cover Hinge Pin.....
2078	3702	" Delivery Eye Thread Guard.....
2080	3702	" " " " Rivet
2082	3702	" Main Spring.....
398E	3702	" " " Screw.....
2084	3702	" " " Steady Pin.....
466H	3702	" Tension Regulating Screw.....
2086	3702	" " Spring.....
2090	3702	" " " Plate.....
112E	3702	" " " Screw.....
39296	3702	Shuttle complete, Nos. 2073, 2076, 39295 and 44001.....
39487	3702	Shuttle Driver with two 457c.....
39209	3746	" " " 662D, 39210 and two 457c, for purl stitch.....
2049	3702	Shuttle Driver Pin.....
457c	3702	" " Set Screw.....
39210	3746	" " Thread Pull-off, for purl stitch.....
662D	3746	Shuttle Driver Thread Pull-off Screw....
17746	3719	" Race Back with 17747.....
190c	3710	" " " Screw.....
17747	3719	" " " Thread Guard Pin....
63814	—	" " Body.....
63815	3719	Shuttle Race complete, Nos. 17746, 63814 and two 190c.....
158E	3724	Shuttle Race Screw.....
17853	3720	Starting Lever.....
1262c	3726	" " Hinge Screw.....
1662c	3726	" " " " Nut.....
17836	3716	" " Pitman.....
17854	3721	Stop Cam.....
17855	3721	" " Interlocking Rod.....
63977	7236	" " " " Case.....
63978	—	" " " " " 63977 with 18443 and two 193J.....

PARTS FOR MACHINE No. 68-36 111

NO.	PLATE	NAME
63993	—	Stop Cam Interlocking Rod Case 63978 with 63976 and two 1255J.....
*39405	—	Stop Cam Interlocking Rod Case 63993 with 1318D, 17855, 17863, 17864 and 39222.....
39346	3760	Stop Cam Interlocking Rod Case Bracket
63754	—	Stop Cam Interlocking Rod Case Bracket complete, Nos. 1182E, 1196c, 1204E, 1254c, 1262c, 1508E, 1662c, 17853, 17859, 17861, 17862, 17872, 17873, 39346, 39405 and two 898D.....
39347	—	Stop Cam Interlocking Rod Case Bracket 63754 with 39343, 39344 and two 1186J
16532	3722	Stop Cam Interlocking Rod Case Bracket Dowel Pin.....
1343E	3753	Stop Cam Interlocking Rod Case Bracket Screw.....
1204E	3721	Stop Cam Interlocking Rod Case Hinge Screw.....
17859	3720	Stop Cam Interlocking Rod Case Socket Joint.....
898D	3721	Stop Cam Interlocking Rod Case Socket Joint Cap Screw.....
39343	3760	Stop Cam Interlocking Rod Case Spring (flat).....
50682c	7235	Stop Cam Interlocking Rod Case Spring Adjusting Screw.....
1520E	3759	Stop Cam Interlocking Rod Case Spring Adjusting Screw Nut.....
39344	3759	Stop Cam Interlocking Rod Case Spring Bracket with 1520E and 50682c.....
1186J	3701	Stop Cam Interlocking Rod Case Spring Bracket Screw.....
17861	3721	Stop Cam Interlocking Rod Case Stop Stud.....
1254c	3726	Stop Cam Interlocking Rod Case Stop Stud Screw Bushing.....
1508E	3726	Stop Cam Interlocking Rod Case Stop Stud Screw Bushing Lock Nut.....
17862	3721	Stop Cam Interlocking Rod Case Stop Stud Spring.....
18443	3754	Stop Cam Interlocking Rod Case Wearing Block.....
193J	3754	Stop Cam Interlocking Rod Case Wearing Block Screw.....
17863	3721	Stop Cam Interlocking Rod Spring.....
17864	3721	" " " " Stop.....

**LIST OF PARTS COMPLETE
FOR**

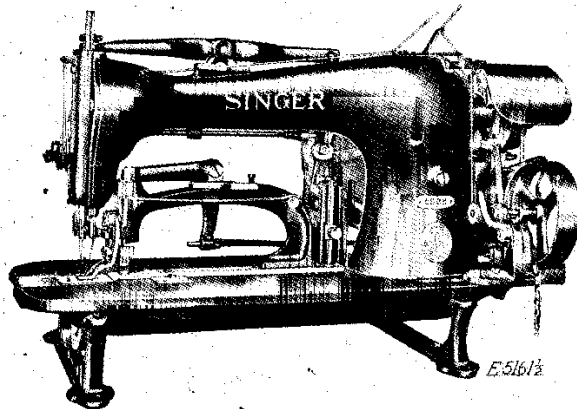

MACHINE No. 68-38

FOR BARRING BUTTONHOLES IN CLOTHING. MAKES BAR $\frac{1}{8}$ IN. TO $\frac{1}{4}$ INCH LONG, CONSISTING OF SEVEN STAYING, ELEVEN COVERING AND THREE TYING STITCHES. THE MACHINE IS FITTED WITH A SPECIAL CLAMP. WHEN THE OPERATOR DEPRESSES THE TREADLE TO LOWER THE CLAMP ON THE WORK, THE CLAMP CONTRACTS THE BUTTONHOLE, SO THAT WHEN THE BARRING OPERATION IS COMPLETED, THE CUT EDGES OF THE BUTTONHOLE LIE CLOSE TOGETHER, GIVING THE BUTTONHOLE A NEAT APPEARANCE.

NO.	PLATE	NAME
63947	7239	Arch Clamp Bar Locating Finger with 63969.....
*63969	7239	Arch Clamp Bar Locating Finger Pointer.
405E	7214	" " " " " Screw..
63948	7236	" " Closing Bell Crank with 51853 and 63825.....
63949	7239	Arch Clamp Closing Bell Crank Bracket
183J	7239	" " " " " " " " " Screw.....

PARTS FOR MACHINE No. 68-38

NO.	PLATE	NAME
63950	7236	Arch Clamp Closing Bell Crank Connecting Rod.....
63951	7239	Arch Clamp Closing Bell Crank Connecting Rod Collar with 237F.....
237F	3724	Arch Clamp Closing Bell Crank Connecting Rod Collar Set Screw.....
28c	7239	Arch Clamp Closing Bell Crank Hinge Screw.....
51853	7239	Arch Clamp Closing Bell Crank Roller and Stud.....
63952	7239	Arch Clamp Closing Bell Crank Spring...
63825	7218	" " " " " " Stud
63953	7240	" " " " Slide.....
63954	7240	" " Foot (left) with 51854.....
63955	7240	" " " (right) with 51854.....
910c	20333	" " " Adjusting Screw.....
63983	20333	" " " " " Bracket
190J	3710	" " " " " " " " " Screw.....
1601J	20333	Arch Clamp Foot Adjusting Screw Nut...
17708	3710	" " " " Lifter with 17866.....
17959	3731	" " " " Lifting Stud.....
63984	20333	" " " " Plate with 17959.....
63985	—	" " " " 63984 with 51041c, 63954, 63955, 63983, 63986 and two each 190J, 910c and 1601J.....
63957	7240	Arch Clamp Foot Plate Cap (lower).....
217J	3731	" " " " " " " " Screw
63958	7240	" " " " " " (upper).....
217J	3731	" " " " " " " " Screw
51854	7240	" " " " Roller and Screw Stud (eccentric) with 1611E.....
1611E	7240	Arch Clamp Foot Roller and Screw Stud Nut.....
63986	20333	Arch Clamp Foot Spring.....
51041c	20333	" " " " " Screw.....
63960	7236	" " " " Frame.....
14079	3731	" " " " Dowel Pin.....
181J	3738	" " " " " Screw.....
63987	20334	" " " " Pressure Spring.....
141c	7240	" " " " " " " " " Regulating Screw.....
788D	7240	Arch Clamp Pressure Spring Screw Stud..
63988	—	Arch Clamp complete, Nos. 28c, 141c, 405E, 788D, 1654c, 39253, 63947 to 63949, 63953, 63957, 63958, 63960, 63965, 63985, 63987, two each 181J, 183J, 1186c, 1651J, 14079, 17803 and four 217J

NO.	PLATE	NAME
*63989	—	Arm with 4449, 15404, 17844 and two each 164E and 15405.....
2002	3722	Arm Dowel Pin.....
4448	3722	" Oil Tube for intermediate bearing...
880E	3724	" Screw.....
17702	3728	" Shaft.....
17703	3711	" " Bushing (back).....
50333C	3788	" " " " Adjusting Screw.....
1520E	3724	Arm Shaft Bushing (back) Adjusting Screw Nut.....
*4449	—	Arm Shaft Bushing (front).....
124674	20334	" Side Cover.....
190J	3710	" " " Screw.....
*17704	—	Bed.....
18498	7202	Belt Cover.....
39290	3743	" " Bracket with 184E and 17741.....
184E	3753	" " " Screw Stud.....
17741	3701	" " " Stud.....
217J	3731	" " " Screw.....
39222	3725	" Shifter.....
63976	7235	" " Clamp.....
1255J	3726	" " " Screw.....
4292	3711	Crank Connecting Rod with two 145E.....
145E	3726	" " " Cap Screw.....
375C	3724	" " " Hinge Screw.....
1518E	3718	" " " " Nut.....
17724	3711	Face Plate.....
*63736	—	" " 17724 with 2105.....
17725	—	Face Plate complete, Nos. 448c, 2107, 2127, 56791, 63736 and two 233J.....
164J	3724	Face Plate Screw.....
2107	3722	" " Thread Guard.....
233J	3722	" " " Screw.....
17726	3714	Feed Across Connection Adjusting Stud.....
1649C	3714	" " " " " " Nut (left).....
1650C	3714	Feed Across Connection Adjusting Stud Nut (right).....
896E	7235	Feed Across Connection Cap Screw.....
63940	7235	" " " (lever end) with two 896E.....
63941	—	Feed Across Connection (lever end) 63940 with 55381.....
55381	7235	Feed Across Connection (lever end) Ball Stud.....
1185c	3714	Feed Across Connection (lever end) Ball Stud Set Screw.....

NO.	PLATE	NAME
63942	7235	Feed Across Connection (regulator end) with two 896E.....
63943	—	Feed Across Connection (regulator end) 63942 with 63944.....
63944	7235	Feed Across Connection (regulator end) Ball Stud.....
17729	3713	Feed Across Lever with 1185c and 1952.....
63963	7236	" " " Bracket with 17732, 63825 and three 160J.....
*17732	—	Feed Across Lever Bracket Cap.....
160J	3714	" " " " Screw.....
8589	3722	" " " " Dowel Pin.....
1177J	3710	" " " " Screw.....
17737	3714	" " " Hinge Stud.....
160J	3714	" " " " Clamping Screw.....
1952	3714	Feed Across Lever Roller and Stud.....
17735	3701	" " Plate with 17741.....
1186c	3701	" " " Screw.....
1651J	3701	" " " Nut.....
17736	3713	" " Regulator.....
50599D	7235	" " " Adjusting Screw Stud.....
1676c	3746	Feed Across Regulator Adjusting Screw Stud Nut.....
46244	7235	Feed Across Regulator Adjusting Screw Stud Nut Washer (fibre).....
17738	3715	Feed Across Regulator Adjusting Screw Stud Nut Washer (steel).....
1188D	3724	Feed Across Regulator Hinge Screw.....
17740	3715	" " " Link.....
1189E	3715	" " " " Screw Stud.....
17741	3701	" " " " Stud.....
17761	—	" Cam with two each 1192c, 17874 and four 190J.....
18415	3746	Feed Cam Driving Worm with 1441c and 1442c.....
1442c	3746	Feed Cam Driving Worm Position Screw.....
1441c	3746	" " " " Set Screw.....
17797	3713	" " " " Wheel with 453c.....
18384	3753	" " " " " Pin.....
453c	3715	" " " " " Set Screw.....
18384	3753	" " Pin.....
1192c	3724	" " Set Screw.....
62155	20334	" " Shaft.....
1653c	3724	" " " Nut.....
63965	7239	" Plate.....

118 PARTS FOR MACHINE No. 68-38

NO.	PLATE	NAME
*39252	3743	Feed Plate Carrier Bar.....
39253	—	“ “ “ “ 39252 with 934j, 1195E, 8505, 17743, 17802, 17804, 18368, two 7476 and four 17806.....
17802	3701	Feed Plate Carrier Bar Block.....
17803	3701	“ “ “ “ “ Cover.....
17804	3701	“ “ “ “ “ Rivet.....
7476	3701	“ “ “ “ “ Steady Pin
17805	3714	“ “ “ “ “ Pivot Block.....
1194D	3714	“ “ “ “ “ Screw
18368	3714	“ “ “ “ “ Plate.....
934J	3714	“ “ “ “ “ Screw.....
1654c	3761	“ “ “ “ “ Nut.....
17806	3701	“ “ “ “ “ Position Stud.....
1195E	3701	“ “ “ “ “ Screw Stud.....
8505	20333	“ “ “ “ “ Rivet.....
17742	3713	“ “ “ “ “ Regulator with 1953.....
17744	3715	“ “ “ “ “ Hinge Stud.....
17743	3715	“ “ “ “ “ Post.....
1953	3715	“ “ “ “ “ Roller and Screw Stud with 1655c and 14017.....
1655c	3715	Feed Regulator Roller and Screw Stud Nut.....
14017	3715	Feed Regulator Roller and Screw Stud Nut Washer.....
1190c	3715	Feed Regulator Stop Screw.....
17745	3715	“ “ “ “ “ Swivel.....
1191D	3715	“ “ “ “ “ Thumb Screw.....
17807	3717	Knife (needle thread).....
17808	3717	“ (shuttle thread).....
*63806	—	“ “ “ “ “ Bar.....
63807	—	“ “ “ “ “ 63806 with 63808, 63809 and two 17814.....
39299	3752	Knife Bar 63807 with 704c and 39300....
17810	3700	“ “ “ “ “ Cap (back).....
690J	3748	“ “ “ “ “ Screw.....
17811	3700	“ “ “ “ “ (front).....
160J	3714	“ “ “ “ “ Screw.....
39262	3754	“ “ “ “ “ (intermediate).....
39263	—	“ “ “ “ “ 39262 with 1328E, 1517E, 39264 and 39265.....
690J	3748	Knife Bar Cap (intermediate) Screw.....
39264	3754	“ “ “ “ “ Stop Pin...
1328E	3754	“ “ “ “ “ “ “ Screw Bushing.....
1517E	3754	Knife Bar Cap (intermediate) Stop Pin Screw Bushing Nut.....

PARTS FOR MACHINE No. 68-38 119

NO.	PLATE	NAME
39265	3754	Knife Bar Cap (intermediate Stop Pin Spring).....
63808	7206	Knife Bar Connection.....
17814	3700	“ “ “ “ “ Rivet.....
17915	3700	“ “ “ “ “ Slide Block.....
63809	—	“ “ “ “ “ “ “ 17915 with 63810.....
63810	7206	Knife Bar Connection Slide Block Stud...
39297	3753	“ “ “ “ “ Driving Lever with 190j, 1420E, 17919 and 39298.....
1382F	3753	Knife Bar Driving Lever Hinge Screw
1681c	3753	“ “ “ “ “ “ “ Nut.....
39298	3753	Knife Bar Driving Lever Lock Stud.....
17919	3700	“ “ “ “ “ “ “ Spring
190J	3710	“ “ “ “ “ “ “ Screw.....
1420E	3753	Knife Bar Driving Lever Lock Stud Stop Screw.....
17820	3716	Knife Bar Extension.....
17750	—	“ “ “ “ “ 17820 with 17821 and two 17822.....
190J	3710	Knife Bar Extension Screw.....
7071	3746	“ “ “ “ “ Washer.....
17821	3717	“ “ “ “ “ Rack.....
17822	3717	“ “ “ “ “ Rivet.....
39300	3754	“ “ “ “ “ Stop Block.....
19793	3746	“ “ “ “ “ Dowel Pin.....
704c	3754	“ “ “ “ “ Screw.....
39235	3758	“ “ “ “ “ Cam Lever Body.....
39409	—	“ “ “ “ “ 39235 with 39460
39329	3758	Knife Cam Lever complete, Nos. 19793 and 39409.....
39332	3758	Knife Cam Lever Bracket with 1177J....
8589	3722	“ “ “ “ “ Dowel Pin.....
1177J	3710	“ “ “ “ “ Screw.....
50029c	3759	“ “ “ “ “ Hinge Screw.....
18471	3759	“ “ “ “ “ “ “ Bushing
18472	—	“ “ “ “ “ “ “ 18471 with 50029c.....
1177J	3710	Knife Cam Lever Hinge Screw Bushing Clamping Screw.....
1980	3759	Knife Cam Lever Roller and Screw Stud with 1654c.....
1654c	3701	Knife Cam Lever Roller and Screw Stud Nut.....

120 PARTS FOR MACHINE No. 68-38

NO.	PLATE	NAME
39330	3759	Knife Cam Lever Slide with 1980.....
39460	—	“ “ “ “ 39330 with 1255J and 39331.....
1255J	3726	Knife Cam Lever Slide Screw.....
39331	3759	“ “ “ “ Washer....
19793	3746	“ “ “ “ Steady Pin.....
68710	—	“ Holder.....
39269	3755	“ “ 68710 with 1336c, 17826, 17830 and two 7298.....
*39488	—	Knife Holder 39269 with 1198c, 17807, 17808 and 17829.....
17826	3717	Knife Holder Pinion.....
7298	3717	“ “ “ Dowel Pin.....
17827	3717	“ “ “ Stud.....
39270	3755	“ “ “ “ Bracket with 17827.....
50018F	3753	Knife Holder Pinion Stud Bracket Screw
1698E	3753	“ “ “ “ “ “ Nut.....
1198c	3717	Knife Screw.....
17829	3717	“ Thread Holder.....
17830	3717	“ “ “ Position Pin.....
39291	3756	“ “ “ Retainer with 39277 and two 39278.....
39277	3755	Knife Thread Retainer Finger.....
39278	3755	“ “ “ “ Rivet.....
1336c	3755	“ “ “ “ Screw Stud.....
17831	3716	Needle Bar with 237F.....
*39203	3718	“ “ Connecting Link.....
63756	—	“ “ “ “ 39203 with 21629.....
377c	3718	Needle Bar Connecting Link Hinge Screw
1518E	3718	“ “ “ “ “ “ Nut.....
21629	3718	Needle Bar Connecting Stud with 155c...
155c	3718	“ “ “ “ Set Screw...
39350	3743	“ “ Thread Nipper Driving Lever (adjustable) with 39351 and two 335J..
39351	3759	Needle Bar Thread Nipper Driving Lever Extension.....
335J	3759	Needle Bar Thread Nipper Driving Lever Extension Screw.....
1196c	3721	Needle Bar Thread Nipper Driving Lever Hinge Screw.....
39352	3743	Needle Bar Thread Nipper Driving Lever Spring.....

PARTS FOR MACHINE No. 68-38 121

NO.	PLATE	NAME
17834	3718	Needle Bar Thread Nipper Lever with 17835.....
17835	3718	Needle Bar Thread Nipper Lever Bushing
1200D	3718	“ “ “ “ “ Hinge Screw.....
39276	3754	Needle Bar Thread Nipper Lever Spring
1329J	3754	“ “ “ “ “ “ Screw.....
17837	3716	Needle Bar Thread Nipper Rod.....
17838	3718	“ “ “ “ “ Adjusting Stud.....
1651E	3701	Needle Bar Thread Nipper Rod Adjusting Stud Lock Nut.....
17839	3718	Needle Bar Thread Nipper Rod Arm with 196F.....
196F	3718	Needle Bar Thread Nipper Rod Arm Set Screw.....
17840	3716	Needle Bar Thread Nipper Rod Support
190J	3710	“ “ “ “ “ “ Screw.....
237F	3724	Needle Set Screw.....
4304	3711	Oscillating Rock Shaft with 4784.....
3052	3711	“ “ “ Hinge Pin.....
1513J	3724	“ “ “ “ “ Nut.....
635c	3724	“ “ “ “ “ Screw Bearing.....
1513J	3724	Oscillating Rock Shaft Hinge Pin Screw Bearing Nut.....
4784	3702	Oscillating Rock Shaft Oil Pad.....
3053	3716	“ Shaft.....
*15160	—	“ “ “ Crank for 15161.....
15425	—	“ “ “ “ 15162.....
*15161	—	Oscillating Shaft Crank complete, Nos. 462c, 1519E, 15160 and 15171.....
15162	3702	Oscillating Shaft Crank complete, Nos. 1519E, 15171, 15425 and two 462c.....
2049	3702	Oscillating Shaft Crank Pin.....
462c	3702	“ “ “ Set Screw.....
15170	3702	“ “ “ Slide Block.....
226J	7215	“ “ “ “ “ C a p Screw.....
12424	3702	Oscillating Shaft Crank Slide Block Cap Screw Washer.....
1035c	3702	Oscillating Shaft Crank Slide Block Screw Stud.....
1519E	3702	Oscillating Shaft Crank Slide Block Screw Stud Nut.....

NO.	PLATE	NAME
15171	3702	Oscillating Shaft Crank Slide Block complete, Nos. 226r, 1035c, 12424 and 15170
2058	3716	Presser Bar.....
17841	3718	" " Collar with two 196f.....
196f	3718	" " " Set Screw.....
17842	3718	" " Guide Bracket with 453c.....
453c	3715	" " " " Set Screw.....
17843	3711	" " Lifting Lever.....
17844	3711	" " " " Bracket.....
164E	3724	" " " " Screw..
1201c	3700	" " " " Hinge Screw....
17845	3716	" " " " Rod.....
17846	—	" " " " Chain.....
32675	20333	" " Spring.....
68712	20340	Pulley (loose) 2¾ in. diam., with 200584d.
68713	—	" " 68712 with 68714.....
68714	20340	" " Ball Bearing.....
68715	20339	" " Bushing.....
51387r	20339	" " Cap Screw.....
200584d	20339	" " Oil Plug Screw.....
68716	20340	" (tight) 2¾ in. diam.....
68720	—	" " 68716 with 1206c and 17854
2022	3722	" " Pin.....
68717	—	Pulleys (ball bearing) complete, Nos. 51387r, 68713, 68715 and 68720.....
2073	3702	Shuttle Bobbin.....
2211	3702	" " Retaining Spring.....
2212	3702	" " " " Rivet...
*39295	—	" Body with 398E, 2082, 2084, 2211 and two 2212.....
*2075	—	Shuttle Cover.....
*44001	—	" " 2075 with 112E, 466H, 2073, 2080, 2086 and 2090.....
2076	3702	Shuttle Cover Hinge Pin.....
2078	3702	" Delivery Eye Thread Guard.....
2080	3702	" " " " Rivet
2082	3702	" Main Spring.....
398E	3702	" " " Screw.....
2084	3702	" " " Steady Pin.....
466H	3702	" Tension Regulating Screw.....
2086	3702	" " Spring.....
2090	3702	" " " Plate.....
112E	3702	" " " Screw.....
39296	3702	Shuttle complete, Nos. 2073, 2076, 39295 and 44001.....
39487	3702	Shuttle Driver with two 457c.....
2049	3702	" " Pin.....
457c	3702	" " Set Screw.....
17746	3719	" Race Back with 17747.....
190c	3710	" " " Screw.....

NO.	PLATE	NAME
17747	3719	Shuttle Race Back Thread Guard Pin....
63814	—	" " Body.....
63815	3719	Shuttle Race complete, Nos. 17746, 63814 and two 190c.....
158E	3724	Shuttle Race Screw.....
63966	7236	Starting Lever.....
1262c	3726	" " Hinge Screw.....
1662c	3726	" " " " Nut.....
17886	3716	" " Pitman.....
17854	3721	Stop Cam.....
17855	3721	" " Interlocking Rod.....
63977	7236	" " " " Case.....
63978	—	" " " " " 63977 with 18443 and two 193j.....
63993	—	Stop Cam Interlocking Rod Case 63978 with 63976 and two 1255r.....
*39405	—	Stop Cam Interlocking Rod Case 63993 with 1318d, 17855, 17863, 17864 and 39222.....
39346	3760	Stop Cam Interlocking Rod Case Bracket
63967	—	Stop Cam Interlocking Rod Case Bracket complete, Nos. 1182E, 1196c, 1204E, 1254c, 1262c, 1508E, 1662c, 17859, 17861, 17862, 17872, 17873, 39346, 39405, 63966 and two 898d.....
63968	—	Stop Cam Interlocking Rod Case Bracket 63967 with 39343, 39344 and two 1186j
16532	3722	Stop Cam Interlocking Rod Case Bracket Dowel Pin.....
1343E	3753	Stop Cam Interlocking Rod Case Bracket Screw.....
1204E	3721	Stop Cam Interlocking Rod Case Hinge Screw.....
17859	3720	Stop Cam Interlocking Rod Case Socket Joint.....
898D	3721	Stop Cam Interlocking Rod Case Socket Joint Cap Screw.....
39343	3760	Stop Cam Interlocking Rod Case Spring (flat).....
50682c	7235	Stop Cam Interlocking Rod Case Spring Adjusting Screw.....
1520E	3759	Stop Cam Interlocking Rod Case Spring Adjusting Screw Nut.....
39344	3759	Stop Cam Interlocking Rod Case Spring Bracket with 1520E and 50682c.....
1186j	3701	Stop Cam Interlocking Rod Case Spring Bracket Screw.....

NO.	PLATE	NAME
17861	3721	Stop Cam Interlocking Rod Case Stop Stud.....
1254c	3726	Stop Cam Interlocking Rod Case Stop Stud Screw Bushing.....
1508E	3726	Stop Cam Interlocking Rod Case Stop Stud Screw Bushing Lock Nut.....
17862	3721	Stop Cam Interlocking Rod Case Stop Stud Spring.....
18443	3754	Stop Cam Interlocking Rod Case Wearing Block.....
193j	3754	Stop Cam Interlocking Rod Case Wearing Block Screw.....
17863	3721	Stop Cam Interlocking Rod Spring.....
17864	3721	" " " " Stop.....
1318D	3748	" " " " " Screw.....
3012	3722	" " Pin.....
1206c	3721	" " Screw.....
2102	3722	Tension Disc.....
1560c	3722	" Regulating Thumb Nut.....
600c	3722	" Screw Stud.....
16202	—	" " " 600c with 1560c.....
448c	3722	" " " Set Screw.....
2103	3722	" Spring.....
2105	3722	" Thread Guard.....
56791	—	Tension complete, Nos. 2103, 2124, 16202 and two 2102.....
*63749	—	Thread Take-up Cam.....
39204	3711	" " " 63749 with 446c....
3012	3722	" " " Pin.....
446c	3724	" " " Set Screw.....
*3072	3711	" " Lever with 1819.....
56855	—	" " " 3072 with 1088c....
1088c	7213	" " " Hinge Screw.....
1819	3724	" " " Roller and Stud....
2124	3722	" " " Spring.....
2127	3722	" " " Regulator Plate.....
233j	3722	" " " " " ".....
		Adjusting Screw.....
17865	3710	Thread Wiper Body.....
1207D	3710	" " " Hinge Screw.....
17866	3710	" " " Hook.....
17867	3710	" " " Support.....
641c	3726	" " " " Set Screw....
17868	3710	" " " Wire.....
337j	3718	" " " " Screw.....
17869	3710	" " " " Washer..
63997	—	Throat Plate Body.....

NO.	PLATE	NAME
39292	3756	Throat Plate 63997 with 17749, 17871 and two each 1208D and 50406D.....
39406	—	Throat Plate 39292 with 1698E, 39270, 39291, 39488 and 50018F.....
39293	—	Throat Plate 63997 with 17749, 17924 and two each 1208D and 50406D.....
39475	—	Throat Plate 39293 with 1698E, 39270, 39291, 39488 and 50018F.....
17749	3723	Throat Plate Extension.....
50406D	7213	" " " Screw.....
17871	3723	" " Needle Hole Bushing for 39292.....
17924	3723	Throat Plate Needle Hole Bushing for 39293.....
1208D	3723	Throat Plate Needle Hole Bushing Screw.....
691F	3724	" " " Screw.....
17872	3721	Trip Lever.....
1196c	3721	" " Hinge Screw.....
17873	3721	" " Spring.....
1182E	3705	" " " Screw.....
17874	3717	Tripping Point.....
190j	3710	" " Screw.....
*15404	—	Trade Mark.....
15405	20333	" " Rivet.....

CLAMPS

BUTTON CLAMP (End Opening)

FOR MACHINES NOS. 68-1, 68-4, 68-6 AND 68-7

NO.	PLATE	NAME
17926	3706	Button Clamp with 1220E and 17928.....
17927	3706	" " Arm with 17714 and 63788.....
63788	7205	" " " Hook.....
17928	3706	" " Position Stud.....
17712	3710	" " Pressure Spring.....
17714	3704	" " " Guide Block.....
1220E	3706	" " Screw Stud.....
17929	3706	" " Spring, for flat buttons....
17930	3706	" " " stud back buttons.....
1208J	3723	" " Screw.....
1656j	3706	" " Thumb Nut.....
17931	—	Button Clamp (end opening) complete, Nos. 17926, 17929 or 17930 and two 1208J.....
17932	—	Button Clamp (end opening) with Arm complete, Nos. 1656j, 17927 and 17931.....

BUTTON CLAMP (Side Opening)

FOR MACHINES NOS. 68-1, 68-4, 68-6 AND 68-7

NO.	PLATE	NAME
17933	3707	Button Clamp with 1220E and 17928.....
17927	3706	" " Arm with 17714 and 63788
63788	7205	" " " Hook.....
17928	3706	" " Position Stud.....
17712	3710	" " Pressure Spring.....
17714	3704	" " " " Guide Block
1220E	3706	" " Screw Stud.....
17934	3707	" " Spring, for flat buttons...
17935	3707	" " " " stud back buttons.....
1208J	3723	Button Clamp Spring Screw.....
1656J	3706	" " Thumb Nut.....
17936	—	Button Clamp (side opening) complete, Nos. 17933, 17934 or 17935 and two 1208J.....
17937	—	Button Clamp (side opening) with Arm complete, Nos. 1656J, 17927 and 17936

CLAMP FOR HOOKS AND EYES

FOR MACHINES NOS. 68-6 AND 68-7

NO.	PLATE	NAME
17906	3709	Clamp (left) with 23219.....
17907	3709	" (right).....
17908	3709	" Arm with 17714 and 63788.....
63788	7205	" " Hook.....
1175J	3704	" Hinge Screw.....
17911	3709	" Hook Stop.....
1208J	3723	" " " Screw.....
17712	3710	" Pressure Spring.....
17713	3710	" " " Bracket.....
1177J	3710	" " " " Screw....
17714	3704	" " " Guide Block.....
1219J	3709	" Spreader Stud.....
1657J	3709	" " " Thumb Nut.....
17718	3705	" " " " Washer
17909	3709	" " " Spring.....
1182J	3705	" " " Screw.....
17910	3709	" Spring.....
1208J	3723	" " Screw.....
23219	3709	" " Steady Pin.....
17912	—	Clamp complete, Nos. 1182J, 1219J, 1657J, 17718, 17906 to 17911 and two each 1175J and 1208J.....

CLAMP FOR TYING FRENCH KNOTS

FOR MACHINE NO. 68-6

NO.	PLATE	NAME
17946	3729	Clamp with 17948.....
17947	3729	" Arm with 17714 and 63788.....
63788	7205	" " Hook.....
17948	3729	" Hinge Stud.....
17949	3729	" " " Pin.....
1263J	3729	" Leveling Thumb Screw.....
17950	3729	" " " " Stop Bracket
220J	3729	" " " " " " "
		Screw.....
17712	3710	Clamp Pressure Spring.....
17713	3710	" " " " Bracket.....
1177J	3710	" " " " Screw....
17714	3704	" " " Guide Block.....
17951	3729	" Stretching Ring.....
1264J	3729	" " " Hinge Screw.....
17952	3729	" " " Spring.....
220J	3729	" " " " Adjusting Screw.....
578K	3729	Clamp Stretching Ring Spring Screw.....
17953	—	Clamp complete, Nos. 578K, 1263J, 17946, 17947, 17949 to 17952, two 1264J and three 220J.....
17954	3735	Feed Plate.....
39205	3743	Guide with 460C.....
460C	3746	" Set Screw.....

IRON BASE

NO.	PLATE	NAME
39483	7214	Bed Frame Cushion (leather).....
39325	3746	" " Hinge Connector.....
9261	3746	" " " " Pin.....
453C	3715	" " " " Set Screw..
39232	3749	" " Side Cover.....
39233	3749	" " with 39232, two each 9261, 39325, 39483 and four wood screws 1¼ in. No. 12.....
39234	3750	Drip Pan.....

ATTACHMENTS AND ACCESSORIES

NO.	PLATE	NAME
120346	4079	Oiler (copper plated) with 120347.....
120347	4079	Oiler Spout, 8½ in. long.....
41400	7211	Machine Rest Pin (wood) 3½ in. long....
11831	7200	Screw Driver (large).....
26026	3727	" " (medium).....
26485	3727	" " (small).....
17875	7202	Table Bracket Machine Holder with 2809, 7263, 39484 and two wood screws 1¼ in. No. 10.....
7263	3718	Table Bracket Machine Holder Connection
2809	3718	" " " " " "
		Hinge Pin.....
453c	3798	Table Bracket Machine Holder Connection Set Screw.....
39484	3718	Table Bracket Machine Holder Cushion (leather).....
120341	4079	Tweezers (curved).....
4822	3727	Wrench for 1528, 1547 and 1698.....
10875	3727	" " 1517, 1518, 1519, 1520, 1611, 1649, 1650 and 1662.....
17905	3727	Wrench for 1178, 1654, 1655, 1676 and 1681.....
22003	3727	Wrench for 1550 and 1651.....
27662	3727	" " 1254 and 1508.....

TAPE HOLDER

(6 IN. DISC)

FOR NO. 68-28 MACHINE

NO.	PLATE	NAME
26910	3799	Bracket Wire.....
28806	—	Bracket Wire complete, Nos. 26910, 26914 and 26918.....
26914	3799	Disc, 6 in.....
26069	—	" Hub.....
26916	3799	Disc complete, Nos. 26069 and 26914.....
26918	3799	Tape Guide.....
26073	20333	Tension Adjusting Collar with 286B.....
286B	3798	" " " Thumb Screw..
13211	20333	" " Spring.....
28807	3799	Tape Holder (straight) complete, Nos. 13211, 26073, 26916 and 28806.....
196F	3718	Tape Holder Set Screw.....

BOBBIN WINDER

(SWINGING AUTOMATIC, LEFT HAND)

FOR 2073

NO.	PLATE	NAME
41598	3780	Base with 27916 and two 28084.....
1186c	3781	" Screw.....
27916	3781	Brake (leather).....
28084	3781	" Rivet.....
27321	3781	Frame.....
50356D	7215	" Hinge Screw.....
1620J	7215	" " " Nut.....
41825	3781	" Spring.....
41600	3780	Pulley with 155c.....
155c	3718	" Set Screw.....
27305	3781	Spindle.....
27326	3781	Stop Latch.....
35D	3724	" " Hinge Screw.....
60769	3780	Tension Bracket.....
60770	3780	Tension Bracket complete, Nos. 419E, 1562J, 8422, 9780, 43808, 60769 and two 2455.....
9780	3781	Tension Bracket Position Stud.....
161J	3724	" " Screw.....
2455	3781	" Disc.....
419E	7214	" Screw Stud.....
1562J	3722	" Regulating Thumb Nut.....
43808	7214	" Spring.....
8422	3781	" Thread Guide.....
41713	3780	Bobbin Winder, Nos. 35D, 1620J, 27305, 27321, 27326, 41598, 41600, 41825 and 50356D.....
41714	—	Bobbin Winder (swinging automatic, left hand) complete, Nos. 161J, 41713, 60770 and two 1186c.....

BOBBIN WINDER

(SWINGING AUTOMATIC, LEFT HAND)

FOR 2996

This Bobbin Winder is the same as No. 41714
with the following exceptions:

NO.	PLATE	NAME
15072	7215	Bobbin Position Pin.....
*27849	—	Spindle.....

NO.	PLATE	NAME
27538	20334	Spindle 27849 with 15072, 27850 and 41828, in place of 27305.....
*27850	—	Spindle Collar.....
41828	—	" " Pin.....
27328	20334	Stop Latch, in place of 27326.....
41604	—	Bobbin Winder, Nos. 35D, 1620r, 27321, 27328, 27538, 41598, 41600, 41825 and 50356D, in place of 41713.....
41716	—	Bobbin Winder (swinging automatic, left hand) complete, Nos. 161j, 41604, 60770 and two 1186c.....

PROTECTOR

NO.	PLATE	NAME
39489	7008	Arm with 39490.....
160c	7009	" Clamping Screw.....
39490	—	Blade.....
39491	7008	Bracket with two each 426c and 448c.....
426c	7009	" Adjusting Screw.....
50351j	7009	" Screw.....
39492	7009	Crank with 160c.....
39493	7009	" Bracket with 1120c and two 454c..
454c	7009	" " Set Screw.....
52598	7009	" Hinge Stud.....
1120c	7009	" " " Set Screw.....
39494	7008	Rod.....
15261	7009	" Collar with 237F.....
237F	7009	" " Set Screw.....
39495	7009	" Connection.....
176j	7009	" " Screw.....
1099F	7009	" Screw Stud.....
39496	7008	" Sleeve.....
448c	7009	" " Set Screw.....
39497	7009	" Spring.....
15261	7009	" " Collar with 237F.....
237F	7009	" " " Set Screw.....
63753	—	Protector (front of needle) Nos. 1099F, 39489, 39491 to 39494, 39496, 39497, 52598 and two 15261.....
39498	—	Protector (front of needle) complete, Nos. 39495, 63753 and two each 176j and 50351j.....

STARTING LEVER AND FOOT LIFTER PARTS

NO.	PLATE	NAME
6439	—	Chain, 36 in. to 45 in., with 56864 and 56865.....

NOTE: When ordering No. 6439, state length required.

56864	7236	Chain Hook (large).....
56865	7235	" " (small).....
17876	3728	Treadle with 443c.....
17877	3728	" Pitman Rod (lower).....
17878	3728	" " " (upper).....
17879	3728	" " " Clamp with two 161E.....
161E	3724	" " " " Screw.....
17880	3728	Treadle Pitman complete, Nos. 17877 to 17879.....
17881	3716	Treadle Shaft.....
443c	7215	" " Set Screw.....
17882	3718	" Spring.....
17883	3728	" Stand.....
17884	—	Treadle complete, Nos. 17876, 17881 to 17883 and two wood screws 1 in. No. 10
17885	—	Treadle and Pitman complete, for power table, Nos. 17880 and 17884.....

STARTING LEVER ROCK SHAFT

NO.	PLATE	NAME
14224	—	Chain, length 10 $\frac{1}{4}$ in., with 56864.....
56864	7236	" Hook.....
7124	7242	Rock Shaft.....
27683	7242	" " Arm with two 356c.....
356c	20333	" " " Set Screw.....
16128	7242	" " Hanger with two wood screws 1 in. No. 10.....
32134	20334	Rock Shaft Spring.....
2770	7242	" " Stop Dog with 356c.....
356c	20333	" " " " Set Screw.....
63981	—	Starting Lever Rock Shaft complete, Nos. 7124, 14224, 32134 and two each 2770, 16128 and 27683.....

TABLE BELT GUIDE

NO.	PLATE	NAME
39218	3728	Belt Guide with two 168E.....
168E	3748	" " Set Screw.....
17892	3728	Bracket with two 153E.....
17893	3728	Pulley.....
39219	3728	" Shaft (long) with 17896 and 63973
63973	—	" " " wick (braided cotton)
39220	3728	" " (short) with 17896 and 63974
63974	—	" " " Wick (braided cotton)
17896	3718	" " Plug.....
153E	3724	" " Set Screw.....
39221	—	Table Belt Guide complete, Nos. 17892, 39219, 39220, two each 17893, 39218 and three wood screws 1 1/4 in. No. 12...

THREAD LUBRICATOR

NO.	PLATE	NAME
*62818	—	Thread Lubricator Bracket.....
65087	20884	" " " Extension....
50222J	20884	" " " Screw.....
21202	20884	" " " " Friction Washer.....
1529E	20884	Thread Lubricator Bracket Screw Nut....
62819	20884	" " " Oil Pad (felt).....
*62820	—	" " " " Holder.....
65088	—	" " " " " 62820 with 65090.....
65089	20884	Thread Lubricator Oil Pad Holder 65088 with 62819, 62824 and 62827.....
*65090	—	Thread Lubricator Oil Pad Holder Oil Tube.....
62824	20884	Thread Lubricator Oil Pad Retainer....
62830	—	" " " Reservoir.....
17822	20884	" " " " Rivet
8068	20884	" " " " " "
		Washer (inside).....
124371	20884	Thread Lubricator Oil Reservoir Rivet Washer (outside).....
62827	20334	Thread Lubricator Oil Wick (braided cotton).....
65091	20884	Thread Lubricator complete, Nos. 8068, 17822, 62818, 62830, 65089 and 124371
65092	20884	Thread Lubricator 65091 with 1529E, 50222J, 65087 and two 21202.....

THREAD UNWINDER

FOR TWO SPOOLS OR TWO LARGE CONES OF THREAD

NO.	PLATE	NAME
225257	20335	Spool Rest with 201018c.....
150203	20335	" " Cushion (felt).....
225388	20335	" " Rod.....
200383c	7235	" " Set Screw.....
201018c	7235	" " Set Screw.....
202490	20335	" Stand with 200383c.....
225391	20335	Thread Guide.....
201696J	7235	" " Lock Nut.....
225326	20335	" " Position Cap.....
225324	20335	" " Rod with 208E and 225322
208E	3753	" " " Screw.....
225322	20333	" " " Washer.....
225258	20335	Thread Unwinder complete, Nos. 201696J, 202490, 225257, 225324, 225326, 225388, two each 150203, 225391 and three wood screws 1/8 in. No. 12.....
27739	7234	Thread Cone (wood) for large cones.....
225390	7234	" " Holder, for inverted cones..

NOTE: Nos. 27739 and 225390 are used with,
but not included in 225258

OBSOLETE PARTS

NO.	PLATE	NAME
39416	3786	Arch Clamp Foot Lifter for 68-28 Ma- chine.....
39417	7204	Arch Clamp Foot Plate with 1607E and 2000, for 39421.....
39421	—	Arch Clamp complete for 68-28 Machine, Nos. 23K, 108J, 658J, 39410, 39412 to 39415, 39417 to 39420, 39431, 39433, 39438 to 39451, two each 181J, 191K, 1186c, 1229c, 1547J, 1651J, 17803, three each 206F, 1302J, 1472J, five 613J, six 185J and eight 1053J.....
63770	—	Arch Clamp Ring Holder Shank (left) with 39307.....
63771	—	Arch Clamp Ring Holder Shank (right) with 39307.....
*17701	—	Arm with 4449, 15404, 17844 and two each 164E and 15405.....

NO.	PLATE	NAME
*39279	—	Arm with 4449, 15404, 17844 and two each 164E and 15405, for 68-1, 68-4, 68-6, 68-7, 68-9, 68-11, 68-12, 68-14 to 68-31 and 68-36 to 68-38 Machines.....
*39282	—	Arm with 4449, 15404, 17844 and two each 164E and 15405, for 68-10 and 68-32 Machines.....
*39422	—	Arm with 4449, 15404, 17844 and two each 164E and 15405, for 68-28 Machine.....
*63804	—	Arm with 4449, 15404 17844 and two each 164E and 15405, for 68-33 Machine.....
39230	3743	Belt Cover Bracket.....
339F	3748	" " " Screw.....
23375	3743	" " " Hinge Block with 460c.....
23376	3743	" " " " Pin.....
460c	3746	" " " " " Set Screw...
17940	3725	" Shifter.....
17705	3720	" " for 17847 and 17849.....
39201	3725	" "
39223	3726	" " Clamp for 39405 and 63759..
1174J	3724	" " Screw for 17705 and 17940...
1255J	3726	" " " " 39201.....
63737	—	Button Clamp (left) with 1053J, 17723, 63743, 63979 and three 9311, for 63746
63979	7239	Button Clamp (left) Extension for 63737..
63738	—	" " (right) with 1053J, 17723, 63744, 63980 and three 9311, for 63746
63980	7239	Button Clamp (right) Extension for 63738
63739	—	" " Arm with 17714 and 63788, for 63746.....
63751	—	Button Clamp Extension for 63737 and 63738.....
63740	—	Button Clamp Spreader Lever for 63746..
104D	—	" " " " Hinge Screw for 63746.....
63741	—	Button Clamp Spreader Thumb Plate for 63746.....
63742	—	Button Clamp Spreader Thumb Plate Pin for 63745.....
1182E	3705	Button Clamp Spreader Thumb Plate Screw for 63746.....
63743	—	Button Clamp Spring (left) for 63737.....
63744	—	" " (right) for 63738...
63745	—	" " Stop with 17720 and 63742, for 63746.....
1053J	3786	Button Clamp Spring Screw for 63737 and 63738.....

NO.	PLATE	NAME
63746	—	Button Clamp (universal) complete, for 14 to 45 line buttons, adjustable for buttons $\frac{3}{4}$ in. to $\frac{1}{2}$ in. thick, for 68-6 and 68-7 Machines, Nos. 104D, 1180J, 1181J, 1182J, 1182E, 1183J, 17718, 17719, 39242, 63737 to 63741, 63745 and two 1175J.....
17727	3714	Feed Across Knuckle Joint.....
17728	3714	" " " " Connection
1184J	3714	" " " " " Hinge Screw.....
17730	3714	Feed Across-Lever Ball Stud.....
17733	3714	" " " " Socket Bearing.....
17734	3714	" " " " " Block (two pieces).....
145F	3726	Feed Across Lever Socket Bearing Block Set Screw.....
1528J	3726	Feed Across Lever Socket Bearing Block Set Screw Nut.....
1187E	3715	Feed Across Regulator Adjusting Stud
17739	3715	" " " " " Sleeve.....
1652D	3715	Feed Cam Driving Regulator Adjusting Stud Thumb Nut.....
17796	3715	Feed Cam Driving Worm with 453c, for 68-1, 68-4, 68-6, 68-7 and 68-9 to 68-12 Machines.....
17996	3726	Feed Cam Driving Worm with 453c, for 68-14 Machine.....
2117	3722	Feed Cam Driving Worm Pin.....
1299c	3746	" " " " Position Screw.
453c	3715	" " " " Set Screw for 17796 and 17996.....
3012	3722	Feed Cam Driving Worm Wheel Pin....
17798	3713	" " Shaft.....
18416	3712	" " "
17799	3713	" " " Bracket.....
18417	3712	" " " " for 18416.....
1177J	3710	" " " " Screw (back)
1193J	3724	" " " " " (front)...
17809	3725	Knife Bar with 17813 and 17814, for 17816.....
17913	3716	Knife Bar with 17914 and two 17814.....
17914	3700	" " Connection 63808 with 17917, for 17913.....
17916	3700	Knife Bar Connection Slide Block Stud for 17917.....

NO.	PLATE	NAME
39444	7204	Tape Feeding Foot Roller Plate (back) for 39421.....
39445	7204	Tape Feeding Foot Roller Plate (front) for 39421.....
17748	3722	Thread Eyelet (top of arm).....
17870	3723	Throat Plate with 17749, 17871 and two each 1208D and 50406D, for flat buttons, for all machines except 68-9.....
17925	—	Throat Plate with 17749, 17924 and two each 1208D and 50406D, for round bottom buttons, for 68-1, 68-4, 68-6 and 68-7 Machines.....
39214	—	Throat Plate with 17749, 39213 and two each 1208D and 50406D, for 68-9 Machine.....
39273	3755	Throat Plate with 17749, 17871 and two each 1208D and 50406D, for 39271, for flat buttons, for 68-1, 68-4, 68-6, 68-7, 68-10 to 68-12 and 68-14 to 68-17 Machines.....
39274	—	Throat Plate with 17749, 17924 and two each 1208D and 50406D, for 39271, for round bottom buttons, for 68-1, 68-4, 68-6 and 68-7 Machines.....
39275	—	Throat Plate with 17749, 39213 and two each 1208D and 50406D, for 39271, for 68-9 Machine.....

Genuine "SINGER" Needles should be used in "SINGER" Machines.
These Needles and their Containers are marked with the Company's Trade Mark "SIMANCO" 1

Needles in Containers marked "FOR SINGER MACHINES" are NOT "SINGER" made needles. 2

NUMERICAL LIST OF PARTS

NO.	PLATE	NAME
23x	3787	Tape Feeding Foot Holder Hinge Screw for 39421 and 39482.....
28c	7239	Arch Clamp Closing Bell Crank Hinge Screw for 63988.....
35D	3724	Bobbin Winder Stop Latch Hinge Screw for 41604 and 41713.....
79c	3753	Thread Take-up Lever Hinge Screw for 55283.....
86D	3754	Hand Stop Lever Hinge Screw for 68-10 and 68-32 Machines.....
90r	3770	Button Clamp Stop (upper) Lever Hinge Screw for 39392.....
90r	3738	Clamp Arm (lower) Hinge Screw for 17987
90r	3738	“ “ (upper) Hinge Screw for 17987
93r	3754	Hand Stop Lever Rod Connection Screw for 68-10 and 68-32 Machines.....
104D	—	Button Clamp Spreader Lever Hinge Screw for 63746, obsolete.....
105r	3769	Button Clamp Spreader Link (left) Hinge Screw for 39375, for 39392.....
105r	3769	Button Clamp Spreader Link (right) Hinge Screw for 39376, for 39392.....
105r	3769	Button Clamp Stop (front) Lever Hinge Screw for 39392.....
107r	7213	Smocking Indicator (left) Hinge Screw for 63717.....
107r	7213	Smocking Indicator (right) Hinge Screw for 63717.....
108r	3787	Arch Clamp Ring Holder Hinge Screw for 63854.....
108r	3787	Tape Feeding Foot Latch Hinge Screw for 39421 and 39482.....
112E	3702	Shuttle Tension Spring Screw for 44001..
129r	3761	Clamp Arm Bracket Adjusting Screw for 39336.....
141c	7240	Arch Clamp Pressure Spring Regulating Screw for 63988.....
145E	3726	Crank Connecting Rod Cap Screw for 4292.....
145F	3726	Feed Across Lever Socket Bearing Block Set Screw, obsolete.....
145J	3726	Shuttle Race Screw for 68-32 Machine....

140 NUMERICAL LIST OF PARTS

NO. PLATE	NAME
153E 3724	Table Belt Guide Pulley Shaft Set Screw for 17892.....
155c 3718	Bobbin Winder Pulley Set Screw for 41600.....
155c 3718	Needle Bar Connecting Stud Set Screw for 21629.....
158E 3724	Shuttle Race Screw for all machines except 68-32.....
160j 3714	Feed Across Lever Bracket Cap Screw for 17731, 39309 and 63963.....
160j 3714	Feed Across Lever Hinge Stud Clamping Screw for 17731, 39309 and 63963.....
160j 3714	Knife Bar Cap (front) Screw.....
160c 7009	Protector Arm Clamping Screw for 39492
160j 3714	Stop Cam Interlocking Rod Case Stop Stud Screw Bushing Clamping Screw, obsolete.....
161j 3724	Bobbin Winder Tension Bracket Screw for 41714 and 41716.....
161E 3724	Starting Lever and Foot Lifter Treadle Pitman Rod Clamp Screw for 17879..
164j 3724	Face Plate Screw.....
164j 3724	Guide Pointer Screw for 68-27 Machine..
164E 3724	Presser Bar Lifting Lever Bracket Screw for 17701, 39279, 39282, 39422, 63804 and 63989 to 63992.....
164j 3724	Stop Cam Interlocking Rod Case Extension Screw for 17858, obsolete.....
168E 3748	Table Belt Guide Set Screw for 39218....
172r 7213	Smocking Clamping Blade Holder Bracket Screw for 63717.....
176K 3769	Button Clamp Stop (front) Arm Screw for 39392.....
176j 7009	Protector Rod Connection Screw for 39498.....
181j 3738	Arch Clamp Frame Screw for 39251, 39256, 39421, 39471, 39482, 63728, 63735, 63820, 63854 and 63988.....
181j 3738	Clamp Arm (lower) Bracket Screw for 17987.....
181j 3798	Feed Across Plate Spring Adjusting Bracket Screw for 68-28 Machine.....
183j 7239	Arch Clamp Closing Bell Crank Bracket Screw for 63988.....
184E 3753	Belt Cover Bracket Screw Stud for 39290
185r 3786	Arch Clamp Foot Plate Screw for 39421 and 39482.....

NUMERICAL LIST OF PARTS 141

NO. PLATE	NAME
190j 3710	Arch Clamp Foot Adjusting Screw Bracket Screw for 63985.....
190j 3710	Arch Clamp Foot Lifter Screw for 68-9, 68-10, 68-20, 68-24, 68-32 and 68-34 Machines.....
190j 3710	Arch Clamp Foot Plate Screw for 63735..
190j 3710	" " Lifter Screw for 68-27 and 68-33 Machines.....
190j 3710	Arch Clamp Ring Holder Shank Plate Screw for 63854.....
190j 3710	Arm Side Cover Screw.....
190j 3710	Buckle Clamp Lifter Screw for 68-22 Machine.....
190j 3710	Button Clamp Lifter Screw for 68-1, 68-4, 68-6, 68-7, 68-21, 68-25, 68-26, 68-29 and 68-30 Machines.....
190j 3770	Button Clamp Stop (upper) Releasing Arm Screw for 68-25 and 68-26 Machines.....
190j 3710	Clamp Arm Lifter Screw for 68-14 to 68-16, 68-18 and 68-23 Machines.....
190j 3710	Clamp Lifter Screw for 68-19, 68-36 and 68-37 Machines.....
190j 3710	Knife Bar Driving Lever Lock Stud Spring Screw for 39297.....
190j 3710	Knife Bar Extension Screw.....
190j 3710	Needle Bar Thread Nipper Rod Support Screw.....
190c 3710	Shuttle Race Back Screw for 63815.....
190j 3710	Smocking Attachment Lifter Screw for 68-31 Machine.....
190j 3710	Smocking Clamping Blade Screw for 63717
190j 3710	Tripping Point Screw for 17751, 17754, 17756, 17757, 17759 to 17761, 17764 to 17774, 17779, 17780, 17783, 17786, 17787, 18398, 39430, 39473 and 63830..
191K 3786	Arch Clamp Check Screw for 39482.....
191K 3786	" " Foot Screw for 39421 and 39482.....
193j 3754	Stop Cam Interlocking Rod Case Wearing Block Screw for 39280, 39345 and 63978.....
196F 3718	Needle Bar Thread Nipper Rod Arm Set Screw for 17839.....
196F 3718	Presser Bar Collar Set Screw for 17841...
196F 3718	Starting Lever Treadle Extension Set Screw for 17943; obsolete.....

NO. PLATE	NAME
196F 3718	Tape Holder Set Screw for 28807.....
199D 7218	Bar Locating Finger Tripping Lever Hinge Screw Stud Cap Screw for 68-34 Machine, obsolete.....
206F 3787	Tape Feeding Foot Roller Plate (back) Screw for 39421 and 63813.....
206F 3787	Tape Feeding Foot Roller Plate (front) Screw for 39421 and 63813.....
207J 3769	Button Clamp Foot Screw for 39392.....
208E 3753	Thread Unwinder Thread Guide Rod Screw for 225324.....
211K 7208	Arch Clamp Shank Screw for 39471.....
217J 3731	" " Foot Plate Cap (lower) Screw for 63988.....
217J 3731	Arch Clamp Foot Plate Cap (upper) Screw for 63988.....
217J 3731	Arch Clamp Foot Plate Screw for 17969, 39251, 39256, 63728, 63820 and 63839..
217J 3731	Arch Clamp Foot Spring Screw for 17969, 63728 and 63839.....
217J 3731	Arch Clamp Foot Spring Screw (lower) for 39251, 39256 and 63820.....
217J 3731	Arch Clamp Ring Leveling Stud Holder Screw for 63854.....
217J 3731	Arch Clamp Shank Plate Screw for 39471.
217J 3731	" " Spreader Spring Screw for 39471.....
217J 3731	Bar Locating Finger Screw for 68-34 Ma- chine, obsolete.....
217J 3731	Belt Cover Screw.....
217J 3770	Tension Releaser Bracket Screw for 68-25 and 68-26 Machines.....
219K 3767	Arch Clamp Foot Screw for 63729 and 63730.....
220J 3729	Clamp Leveling Thumb Screw Stop Bracket Screw for 17953 and 39226....
220J 3729	Clamp Stretching Ring Spring Adjusting Screw for 17953 and 39226.....
226J 7215	Arch Clamp Indicator Finger Screw for 63854.....
226J 7215	Oscillating Shaft Crank Slide Block Cap Screw for 15171.....
229J 3702	Arch Clamp Indicator Plate Screw for 63854.....
229J 3702	Buckle Clamp Spring Screw for 63971....
229J 3702	Button Clamp Spring Screw for 63928 and 63929.....

NO. PLATE	NAME
229J 3702	Oscillating Shaft Crank Slide Block Cap Screw for 15171, obsolete.....
229J 3702	Tension Releaser Screw for 68-25 and 68-26 Machines.....
233J 3722	Arch Clamp Foot Yielding Presser Spring Screw for 39215.....
233J 3769	Button Clamp Stop (front) Spring Screw for 39392.....
233J 3769	Button Clamp Stop (upper) Lever Spring Screw for 39377, for 39392.....
233J 3770	Button Clamp Stop (upper) Regulator Screw for 39392.....
233J 3722	Face Plate Thread Guard Screw for 17725
233J 3722	Thread Take-up Spring Regulator Plate Adjusting Screw for 17725.....
236J 3705	Bar Locating Finger Holder Extension Screw for 68-34 Machine, obsolete....
236J 3705	Button Clamp Spring Screw for 17898 and 17904.....
237F 3724	Arch Clamp Closing Bell Crank Connect- ing Rod Collar Set Screw for 63951....
237F 3724	Needle Set Screw for 17831 and 63782...
237F 7009	Protector Rod Collar Set Screw for 15261.
237F 7009	" " Spring Collar Set Screw for 15261.....
237K 3724	Smocking Clamping Blade Holder Hinge Pin Collar Set Screw for 27659.....
240J 7237	Clamp Spring Screw for 63939.....
286B 3798	Tape Holder Tension Adjusting Collar Thumb Screw for 26073.....
287J 7213	Smocking Guide Thumb Screw for 63717.
330J 3796	Thread Wiper Body Finger Screw for 68-28 and 68-32 Machines.....
335J 3759	Needle Bar Thread Nipper Driving Lever Extension Screw for 39350.....
337J 3718	Needle Bar Thread Nipper Lever Spring Screw, obsolete.....
337J 3718	Thread Wiper Body Wire Screw for 68-1, 68-4, 68-6, 68-7, 68-9 to 68-12, 68-14 to 68-27, 68-29 to 68-31, 68-34 and 68-36 to 68-38 Machines.....
356C 20333	Starting Lever Rock Shaft Arm Set Screw for 27683.....
356C 20333	Starting Lever Rock Shaft Stop Dog Set Screw for 2770.....
375C 3724	Crank Connecting Rod Hinge Screw....
377C 3718	Needle Bar Connecting Link Hinge Screw

144 NUMERICAL LIST OF PARTS

NO. PLATE	NAME
389F 3748	Belt Cover Bracket Screw, obsolete.....
391J 7214	Shuttle Bobbin Case Position Plate Screw for 63842.....
398E 3702	Shuttle Main Spring Screw for 39295.....
402J 7208	Arch Clamp Arm Screw for 39471.....
405E 7214	" " Bar Locating Finger Screw for 63988.....
405J 7214	Feed Plate Screw for 63820, obsolete.....
419E 7214	Bobbin Winder Tension Screw Stud for 60770.....
426c 7009	Protector Bracket Adjusting Screw for 39491.....
430c 3759	Stop Cam Interlocking Rod Case Spring Adjusting Screw for 39344, obsolete....
443c 7215	Starting Lever and Foot Lifter Treadle Shaft Set Screw for 17876 and 17943...
446c 3724	Thread Take-up Cam Set Screw for 18392, 39204 and 39324.....
448c 7009	Protector Rod Sleeve Set Screw for 39491
448c 3722	Tension Screw Stud Set Screw for 17725..
453c 3715	Bed Frame Hinge Connection Set Screw for 39233.....
453c 3715	Feed Cam Driving Worm Set Screw for 17796 and 17996, obsolete.....
453c 3715	Feed Cam Driving Worm Wheel Set Screw for 17797, 17997 and 39212.....
453c 3715	Presser Bar Guide Bracket Set Screw for 17842.....
453c 3798	Table Bracket Machine Holder Connec- tion Set Screw (Attachments and Acces- sories).....
454c 7009	Protector Crank Bracket Set Screw for 39493.....
457c 3702	Shuttle Driver Set Screw for 39209 and 39487.....
460c 3746	Belt Cover Hinge Block Pin Set Screw for 23375, obsolete.....
460c 3746	Guide Set Screw for 39205.....
462c 3702	Oscillating Shaft Crank Set Screw for 15161, 15162, 15164 and 15165.....
462c 3702	Shuttle Driver Set Screw for 2441.....
466H 3702	" Tension Regulating Screw for 44001.....
578x 3729	Clamp Stretching Ring Spring Screw for 17953 and 39226.....
591r 7214	Shuttle Tension Regulating Screw for 33942.....

NUMERICAL LIST OF PARTS 145

NO. PLATE	NAME
592E 7214	Shuttle Bobbin Case Latch Stop Screw for 33942.....
600c 3722	Tension Screw Stud for 16202.....
613J 3787	Tape Feeding Foot Latch Disengaging Wedge Screw for 63813.....
613J 3787	Tape Guide and Cutter Spring Bracket Screw for 39421 and 63813.....
635c 3724	Oscillating Rock Shaft Hinge Pin Screw Bearing.....
641c 3726	Thread Wiper Body Support Set Screw for all machines except 68-33.....
658J 3787	Tape Feeding Foot Head for 39421 and 39482.....
662D 3746	Shuttle Driver Thread Pull-off Screw for 39209.....
690J 3748	Knife Bar Cap (back) Screw.....
690J 3748	" " " (intermediate) Screw.....
691F 3724	Throat Plate Screw.....
704c 3754	Knife Bar Stop Block Screw for 39299.....
706D 7215	Needle Stripper Screw for 63785.....
714J 3769	Button Clamp Stop (front) Spring Thumb Screw for 39392.....
747J 7208	Arch Clamp Spring Adjusting Screw for 39471.....
766D 3770	Thread Wiper Body Hinge Screw for 68-25 and 68-26 Machines.....
788D 7240	Arch Clamp Pressure Spring Screw Stud for 63988.....
810D 3759	Feed Regulator Post Guide Cap Screw for 39360.....
871J 3770	Button Clamp Lifting Screw Stud for 68-25 and 68-26 Machines.....
880E 3724	Arm Screw.....
896E 7235	Feed Across Connection Cap Screw for 63940 and 63942.....
898D 3721	Stop Cam Interlocking Rod Case Socket Joint Cap Screw for 39281, 39289, 63752, 63754 and 63967.....
907D 7214	Shuttle Race Back Spring Screw for 63842.....
910c 20333	Arch Clamp Foot Adjusting Screw for 63985.....
934J 3714	Feed Plate Carrier Bar Plate Screw for 39253, 39254, 39260, 39301, 39360, 39433, 63703 and 63833.....
957x 3738	Clamp Spreader Lever Cap Screw for 17987.....

NO. PLATE	NAME
1019c 3754	Hand Stop Lever Rod Collar Set Screw for 21678.....
1035c 3702	Oscillating Shaft Crank Slide Block Screw Stud for 15171.....
1053j 3786	Arch Clamp Check Shield Screw for 39482
1053j 3786	Button Clamp Spring Screw for 63737 and 63738, obsolete.....
1053j 3786	Shuttle Race Cap Screw for 63946.....
1053j 3786	Tape Cutting Blade Screw for 39421 and 63813.....
1057e 7213	Smocking Guide Holder Clamping Screw for 63713.....
1088c 7213	Thread Take-up Lever Hinge Screw for 56855.....
1099f 7009	Protector Rod Screw Stud for 63753.....
1120c 7009	" Crank Hinge Stud Set Screw for 39493.....
1120k 7213	Smocking Clamping Blade Holder Hinge Pin Set Screw for 63706.....
1127j 3769	Button Clamp Stop (upper) Thumb Screw for 39392.....
1145j 3770	Button Clamp Stop (upper) Lever Spring Screw for 39387, for 39392.....
1174j 3724	Belt Shifter Screw for 17705 and 17940, obsolete.....
1175j 3704	Arch Clamp Hinge Screw for 39471.....
1175j 3704	" " Foot Spring Connection Hinge Screw for 17969, 63728 and 63839.....
1175j 3704	Arch Clamp Foot Spring Screw (upper) for 39251 and 39256.....
1175j 3704	Buckle Clamp Hinge Screw for 63971...
1175j 3704	Button Clamp Hinge Screw for 17898, 17904, 63746, 63928 and 63929.....
1175j 3769	Button Clamp (left) Hinge Screw for 39392.....
1175j 3769	Button Clamp (right) Hinge Screw for 39392.....
1175j 3769	Button Clamp Spreader Link Hinge Screw for 39392.....
1175j 3704	Clamp Hinge Screw for 17912, 39319 and 63939.....
1176j 3704	Buckle Clamp Arm Hinge Plate Screw for 68-22 Machine.....
1176j 3704	Button Clamp Arm Hinge Plate Screw for 68-1, 68-4, 68-6, 68-7, 68-21, 68-25, 68-26, 68-29 and 68-30 Machines.....

NO. PLATE	NAME
1176j 3704	Clamp Arm Hinge Plate Screw for 68-19, 68-36 and 68-37 Machines.....
1176d 3788	Feed Across Plate Spring Screw for 68-23 Machine.....
1177j 3710	Arch Clamp Frame Screw for 17969 and 63839.....
1177j 3710	Buckle Clamp Pressure Spring Bracket Screw for 68-22 Machine.....
1177j 3710	Button Clamp Pressure Spring Bracket Screw for 68-1, 68-4, 68-6, 68-7, 68-21, 68-25, 68-26, 68-29 and 68-30 Machines
1177j 3710	Clamp Pressure Spring Bracket Screw for 17912, 17953, 17987 and 68-17, 68-19, 68-36 and 68-37 Machines.....
1177j 3710	Feed Across Lever Bracket Screw.....
1177j 3710	Feed Cam Shaft Bracket Screw (back) obsolete.....
1177j 3710	Knife Cam Lever Bracket Screw.....
1177j 3710	" " " Hinge Screw Bushing Clamping Screw for 39332.....
1177j 3710	Stop Cam Interlocking Rod Case Bracket Screw, obsolete.....
1178j 3710	Buckle Clamp Pressure Spring Screw for 68-22 Machine.....
1178j 3710	Button Clamp Pressure Spring Screw for 68-1, 68-4, 68-6, 68-7, 68-21, 68-25, 68-26, 68-29 and 68-30 Machines.....
1178j 3710	Clamp Arm Screw for 39336.....
1178j 3710	" Pressure Spring Screw for 17987 and 68-17, 68-19, 68-36 and 68-37 Machines.....
1180j 3705	Arch Clamp Spreader Lever Locking Thumb Screw for 39471.....
1180j 3705	Buckle Clamp Buckle Stop Thumb Screw for 63971.....
1180j 3705	Buckle Clamp Spreader Lever Locking Thumb Screw for 63971.....
1180j 3705	Button Clamp Spreader Lever Locking Thumb Screw for 17898, 17904, 63746, 63928 and 63929.....
1180j 3769	Button Clamp Stop (front) Lever Thumb Screw for 39392.....
1180j 3705	Clamp Spreader Lever Locking Thumb Screw for 39319 and 63939.....
1180j 3705	Clamp Stop Thumb Screw for 63939.....
1181j 3705	Buckle Clamp Spreader Spring Screw Stud for 63971.....

NO.	PLATE	NAME
1181J	3705	Button Clamp Spreader Spring Screw Stud for 17898, 17904, 63746, 63928 and 63929.....
1181J	3705	Clamp Spreader Spring Screw for 39319 and 63939.....
1182J	3705	Arch Clamp Spreader Screw for 39471....
1182J	3705	Buckle Clamp Spreader Screw for 63971..
1182J	3705	Button Clamp Spreader Screw for 17898, 17904, 63746, 63928 and 63929.....
1182E	3705	Button Clamp Spreader Thumb Plate Screw for 63746, obsolete.....
1182J	3705	Clamp Spreader Screw for 39319 and 63939.....
1182J	3705	Clamp Spreader Spring Screw for 17912..
1182J	3770	Thread Wiper Body Support Extension Screw for 68-25 and 68-26 Machines....
1182E	3705	Trip Lever Spring Screw for 39281, 39289, 63752, 63754 and 63967.....
1183J	3705	Arch Clamp Stop Screw for 39471.....
1183J	3705	Buckle Clamp Spreader Holder Screw for 63971.....
1183J	3705	Button Clamp Stop Screw for 17898, 17904, 63746, 63928 and 63929.....
1183J	3705	Clamp Spreader Holder Screw for 39319 and 63939.....
1184J	3714	Feed Across Knuckle Joint Connection Hinge Screw, obsolete.....
1185c	3714	Feed Across Connection (lever end) Ball Stud Set Screw for 17729.....
1186c	3781	Bobbin Winder Base Screw for 41714 and 41716.....
1186c	3701	Feed Across Plate Screw for 17969, 17987, 39251, 39256, 39337 to 39339, 39421, 39471, 39482, 63717, 63728, 63735, 63820, 63839, 63854 and 63988, and for 68-1, 68-4, 68-6, 68-7, 68-17, 68-19, 68-21, 68-22, 68-25, 68-26, 68-29, 68-30, 68-36 and 68-37 Machines.....
1186J	3701	Stop Cam Interlocking Rod Case Spring Bracket Screw for 39347, 39349 and 63968.....
1187E	3715	Feed Across Regulator Adjusting Stud, obsolete.....
1188D	3724	Feed Across Regulator Hinge Screw.....
1189E	3715	" " " Link Screw Stud..
1190c	3715	Arch Clamp Foot Spring Screw (upper) for 63820, obsolete.....

NO.	PLATE	NAME
1190c	3715	Feed Regulator Stop Screw for all machines except 68-33.....
1191D	3715	Feed Regulator Thumb Screw.....
1192c	3724	" Cam Set Screw for 17751, 17754, 17756, 17757, 17759 to 17761, 17764 to 17774, 17779, 17780, 17783, 17786, 17787, 18398, 39430, 39473 and 63830..
1193J	3724	Feed Cam Shaft Bracket Screw (front) obsolete.....
1194D	3714	Feed Plate Carrier Bar Pivot Block Screw
1195E	3701	" " Screw Stud for 39253, 39254, 39260, 39360, 39433 and 63703.....
1196c	3721	Knife Bar Driving Lever Hinge Screw for 17816, obsolete.....
1196c	3721	Needle Bar Thread Nipper Driving Lever Hinge Screw.....
1196c	3721	Trip Lever Hinge Screw for 39281, 39289, 63752, 63754 and 63967.....
1197D	3724	Knife Cam Lever Hinge Screw, obsolete..
1198c	3717	" Screw for 39488 and 63844.....
1200D	3718	Needle Bar Thread Nipper Lever Hinge Screw.....
1201c	3700	Presser Bar Lifting Lever Hinge Screw...
1202R	3724	Pulley (loose) Cap Screw for 17955.....
1203c	3724	Starting Lever Hinge Screw, obsolete.....
1204E	3721	Stop Cam Interlocking Rod Case Hinge Screw for 39281, 39289, 63752, 63754 and 63967.....
1205c	3721	Stop Cam Interlocking Rod Case Stop Stud Screw Bushing, obsolete.....
1206c	3721	Stop Cam Screw for 17955.....
1207D	3710	Thread Wiper Body Hinge Screw for all machines except 68-25, 68-26 and 68-33 Machines.....
1208J	3723	Button Clamp Spring Screw for 17931 and 17936.....
1208J	3723	Clamp Hook Stop Screw for 17912.....
1208J	3723	" Spring Screw for 17912 and 39322
1208D	3723	Throat Plate Needle Hole Bushing Screw for 17870, 17925, 39214, 39273, to 39275 39292 to 39294, 39402, 39457, 63786 and 63791.....
1219J	3709	Clamp Spreader Stud for 17912.....
1220E	3706	Buckle Clamp Screw Stud for 39371.....
1220E	3706	Button Clamp Screw Stud for 17926 and 17933.....
1220E	3706	Clamp Screw Stud for 39320.....

From the library of: Diamond Needle Corp

18133410

NO.	PLATE	NAME
1229F	3798	Arch Clamp Check Spring Adjusting Screw for 39482.....
1229F	3767	Arch Clamp Foot Spring Adjusting Screw for 39421, 39482 and 63735.....
1229c	3767	Arch Clamp Spring Adjusting Screw for 63854.....
1254c	3726	Stop Cam Interlocking Rod Case Stop Stud Screw Bushing for 39281, 39289, 63752, 63754 and 63967.....
1255J	3726	Belt Shifter Clamp Screw for 63993.....
1255J	3726	" " Screw for 39201, obsolete....
1255J	3726	Knife Cam Lever Slide Screw for 39460..
1255J	3726	Stop Cam Interlocking Rod Case Extension Screw for 17858 and 63759, obsolete
1259c	7213	Smocking Guide Holder Arm Set Screw for 63706.....
1262c	3726	Starting Lever Hinge Screw for 39281, 39289, 63752, 63754 and 63967.....
1263J	3769	Button Clamp Spreader Thumb Screw for 39392.....
1263J	3729	Clamp Leveling Thumb Screw for 17953 and 39226.....
1264J	3729	Clamp Stretching Ring Hinge Screw for 17953 and 39226.....
1299c	3746	Feed Cam Driving Worm Position Screw, obsolete.....
1300J	3761	Clamp Arm Bracket Hinge, Block Screw for 39336.....
1302J	3769	Button Clamp Stop (front) Arm Holder Plate Screw for 39392.....
1302J	3788	Tape Guide Cap Screw (front) for 39421 and 63813.....
1302J	3788	Thread Wiper Body Wire Clamp Screw for 68-28 and 68-32 Machines.....
1318D	3748	Stop Cam Interlocking Rod Stop Screw for 39405 and 63759.....
1319F	3717	Knife Holder Pinion Stud Bracket Screw, obsolete.....
1328E	3754	Knife Bar Cap (intermediate) Stop Pin Screw Bushing for 39263.....
1329J	3754	Needle Bar Thread Nipper Lever Spring Screw.....
1336c	3755	Knife Thread Retainer Screw Stud for 39269.....
1340c	7206	Arch Clamp Foot Lifter Screw for 63757
1343E	3753	Stop Cam Interlocking Rod Case Bracket Screw.....

NO.	PLATE	NAME
1382F	3753	Knife Bar Driving Lever Hinge Screw....
1420E	3753	" " " " Lock Stud Stop Screw for 39297.....
1441c	3746	Feed Cam Driving Worm Set Screw for 18415, 39211 and 39231.....
1442c	3746	Feed Cam Driving Worm Position Screw for 18415, 39211 and 39231.....
1472J	3788	Tape Guide Cap Screw (back) for 39421 and 63813.....
1508E	3726	Stop Cam Interlocking Rod Case Stop Stud Screw Bushing Lock Nut for 39281, 39289, 63752, 63754 and 63967..
1513J	3724	Oscillating Rock Shaft Hinge Pin Nut....
1513J	3724	" " " " " Screw Bearing Nut.....
1517E	3754	Knife Bar Cap (intermediate) Stop Pin Screw Bushing Nut for 39263.....
1518E	3718	Crank Connecting Rod Hinge Screw Nut
1518E	3718	Needle Bar Connecting Link Hinge Screw Nut.....
1519E	3702	Oscillating Shaft Crank Slide Block Screw Stud Nut for 15161, 15162, 15164 and 15165.....
1520E	3724	Arm Shaft Bushing (back) Adjusting Screw Nut.....
1520E	3759	Stop Cam Interlocking Rod Case Spring Adjusting Screw Nut for 39344.....
1528J	3726	Feed Across Lever Socket Bearing Block Set Screw Nut, obsolete.....
1529E	20884	Thread Lubricator Bracket Screw Nut for 65092.....
1547J	3798	Arch Clamp Check Spring Adjusting Screw Lock Nut for 39482.....
1547J	3767	Arch Clamp Foot Spring Adjusting Screw Lock Nut for 39421, 39482 and 63735..
1547J	3798	Arch Clamp Spring Adjusting Screw Lock Nut for 63854.....
1550J	7208	Arch Clamp Spring Adjusting Screw Lock Nut for 39471.....
1560c	3722	Tension Regulating Thumb Nut for 16202.....
1562J	3722	Bobbin Winder Tension Regulating Thumb Nut for 60770.....
1565D	3754	Hand Stop Lever Rod Head for 68-10 and 68-32 Machines.....
1601J	20333	Arch Clamp Foot Adjusting Screw Nut for 63985.....

NO.	PLATE	NAME
1607j	3769	Button Clamp Stop (front) Nut for 39392
1607E	3786	Tape Feeding Foot Holder Roller and Screw Stud Nut for 39417 and 39478..
1611E	7240	Arch-Clamp Foot Roller and Screw Stud Nut for 51854.....
1620j	7215	Bobbin Winder Frame Hinge Screw Nut for 41604 and 41713.....
1649c	3714	Feed Across Connection Adjusting Stud Nut (left).....
1650c	3714	Feed Across Connection Adjusting Stud Nut (right).....
1651j	3701	Feed Across Plate Screw Nut for 17969, 17987, 39251, 39256, 39337 to 39339, 39421, 39471, 39482, 63717, 63728, 63735, 63820, 63839, 63854 and 63988 and for 68-1, 68-4, 68-6, 68-7, 68-17, 68-19, 68-21, 68-22, 68-25, 68-26, 68-29, 68-30, 68-36 and 68-37 Machines.....
1651E	3701	Needle Bar Thread Nipper Rod Adjusting Stud Lock Nut.....
1651j	3701	Smocking Clamping Blade Lifting Hook Lock Nut for 63717.....
1652D	3715	Feed Cam Driving Regulator Adjusting Stud Thumb Nut, obsolete.....
1653c	3724	Feed Cam Shaft Nut.....
1654c	3761	Clamp Arm Bracket Hinge Screw Nut for 39336.....
1654c	3701	Feed Plate Nut for 17969, 39251, 39256, 39337 to 39339, 39471, 39482, 63717, 63728, 63735, 63839, 63854 and 63988, and for 68-1, 68-4, 68-6, 68-7, 68-17, 68-19, 68-21, 68-22, 68-25, 68-26, 68-29, 68-30, 68-34, 68-36 and 68-37 Machines..
1654c	3701	Knife Cam Lever Roller and Screw Stud Nut for 1980.....
1655c	3715	Feed Regulator Roller and Screw Stud Nut for 1953.....
1656j	3706	Buckle Clamp Screw Stud Thumb Nut for 39372.....
1656j	3706	Button Clamp Thumb Nut for 17932 and 17937.....
1656j	3706	Clamp Thumb Nut for 39323.....
1657j	3709	" Spreader Stud Thumb Nut for 17912.....
1662c	3726	Starting Lever Hinge Screw Nut for 39281, 39289, 63752, 63754 and 63967.....

NO.	PLATE	NAME
1676c	3746	Feed Across Regulator Adjusting Screw Stud Nut.....
1681c	3753	Knife Bar Driving Lever Hinge Screw Nut
1698E	3753	" Holder Pinion Stud Bracket Screw Nut for 39406, 39474, 39475, 39477, 63787, 63794, 63843 and 63845.....
1819	3724	Thread Take-up Lever Roller and Stud for 3072.....
1822	3753	Thread Take-up Lever Roller and Stud for 18393.....
1823	3787	Tape Feeding Foot Roller and Stud for 39439.....
1952	3714	Feed Across Lever Roller and Stud for 17729.....
1953	3715	Feed Regulator Roller and Screw Stud with 1655c and 14017, for 17742, 39312 and 39361.....
1980	3759	Knife Cam Lever Roller and Screw Stud with 1654c, for 39330.....
2000	3786	Tape Feeding Foot Holder Roller and Screw Stud for 39417 and 39478.....
2002	3722	Arm Dowel Pin.....
2022	3722	Pulley (tight) Pin.....
2049	5697	Guide Stop Pin for 68-27 Machine.....
2049	3702	Oscillating Shaft Crank Pin.....
2049	3702	Shuttle Driver Pin.....
2058	3716	Presser Bar, for all machines except 68-28.
2073	3702	Shuttle Bobbin for 39296.....
*2075	—	" Cover for 44001.....
2076	3702	" " Hinge Pin for 39296.....
2078	3702	" Delivery Eye Thread Guard for 44001.....
2080	3702	Shuttle Delivery Eye Thread Guard Rivet for 44001.....
2082	3702	Shuttle Main Spring for 39295.....
2084	3702	" " " Steady Pin for 39295
2086	3702	" Tension Spring for 44001.....
2090	3702	" " " Plate for 44001...
2102	3722	Tension Disc for 56791.....
2103	3722	" Spring for 56791.....
2105	3722	" Thread Guard for 63736.....
2107	3722	Face Plate Thread Guard for 17725.....
2117	3722	Feed Cam Driving Worm Pin, obsolete...
2124	3722	Thread Take-up Spring for 56791.....
2127	3722	" " " Regulator Plate for 17725.....

NO.	PLATE	NAME
2211	3702	Shuttle Bobbin Retaining Spring for 39295.....
2212	3702	Shuttle Bobbin Retaining Spring Rivet for 39295.....
2269	3770	Button Clamp Stop (upper) Releasing Arm Pin for 68-25 and 68-26 Machines..
2269	3722	Pulley (loose) Bushing Position Pin for 17849 and 17942.....
2441	7214	Shuttle Driver 2542 with two 462c, for 68-32 Machine.....
2455	3781	Bobbin Winder Tension Disc for 60770...
2515	7214	Shuttle Body for 63535.....
2523	7214	" Bobbin Case Position Finger Rivet for 33942.....
2523	7214	Shuttle Race Cap Steady Pin for 63946...
		Nos. 2531 to 2533 for 63842
2531	7211	Shuttle Race Back.....
2532	7214	" " " Position Pin.....
2533	7211	" " " Spring.....
*2542	—	" Driver for 2441.....
2770	7242	Starting Lever Rock Shaft Stop Dog with 356c, for 63981.....
2809	3718	Table Bracket Machine Holder Connection Hinge Pin for 17875.....
2973	7214	Shuttle Bobbin Case Latch Lever for 15141.....
2974	7214	Shuttle Bobbin Case Latch Lever Fulcrum Pin for 15141.....
2975	7214	Shuttle Bobbin Case Latch Spring for 33942.....
2996	7214	Shuttle Bobbin for 63535.....
3012	3722	Feed Cam Driving Worm Wheel Pin, obsolete.....
3012	3722	Stop Cam Pin.....
3012	3722	Thread Take-up Cam Pin.....
3052	3711	Oscillating Rock Shaft Hinge Pin.....
3053	3716	" Shaft for all machines except 68-32.....
*3072	3711	Thread Take-up Lever with 1819, for 56855.....
3168	7211	Oscillating Shaft for 68-32 Machine.....
4292	3711	Crank Connecting Rod with two 145e....
4304	3711	Oscillating Rock Shaft with 4784.....
4448	3722	Arm Oil Tube for intermediate bearing...

NO.	PLATE	NAME
*4449	—	Arm Shaft Bushing (front) for 17701, 39279, 39282, 39422, 63804 and 63989 to 63992.....
4784	3702	Oscillating Rock Shaft Oil Pad for 4304...
4822	3727	Wrench for 1528, 1547 and 1698 (Attachments and Accessories).....
5569	3770	Button Clamp Stop (upper) Lever Spring for 39392.....
6439	—	Starting Lever and Foot Lifter Chain, 36 in. to 45 in., with 56864 and 56865..
7071	3746	Arch Clamp Spreader Spring Screw Washer for 39471.....
7071	3746	Bar Locating Finger Screw Washer for 68-34 Machine, obsolete.....
7071	3746	Knife Bar Extension Screw Washer.....
7124	7242	Starting Lever Rock Shaft for 63981.....
7263	3718	Table Bracket Machine Holder Connection for 17875.....
7298	3717	Knife Holder Pinion Dowel Pin for 17825 and 39269.....
7401	3738	Clamp Arm (lower) Bracket Steady Pin for 17987.....
7476	3701	Feed Plate Carrier Bar Block Steady Pin for 17987, 39253, 39254, 39260, 39360, 39433, 63703 and 63833.....
7553	7214	Shuttle Bobbin Case Position Finger for 33942.....
8068	20884	Thread Lubricator Oil Reservoir Rivet Washer (inside) for 65091.....
8282	7215	Arch Clamp Ring Compensating Stud Spring for 63854.....
8422	3781	Bobbin Winder Tension Thread Guide for 60770.....
8505	20333	Feed Plate Screw Stud Rivet for 39253, 39254, 39260, 39360, 39433 and 63703..
8589	3722	Feed Across Lever Bracket Dowel Pin....
8589	3722	Knife Cam Lever Bracket Dowel Pin....
9261	3746	Bed Frame Hinge Connection Pin for 39233.....
9311	3747	Buckle Clamp Spring Steady Pin for 39363 and 39364.....
9311	3747	Button Clamp Spring Steady Pin for 18464, 18465, 39238, 39239, 63737 and 63738.....
9311	3747	Clamp Spring Steady Pin for 63933 and 63934.....

NO.	PLATE	NAME
9558	3757	Clamp Buckle Stop Rivet for 39314 and 39315.....
9780	3781	Bobbin Winder Tension Bracket Position Stud for 60770.....
10875	3727	Wrench for 1517, 1518, 1519, 1520, 1611, 1649, 1650 and 1662 (Attachments and Accessories).....
11831	7200	Screw Driver, large (Attachments and Accessories).....
12424	3702	Oscillating Shaft Crank Slide Block Cap Screw Washer for 15171.....
13211	20333	Tape Holder Tension Adjusting Spring for 28807.....
14008	3737	Clamp Arm (upper) Bracket Hinge Pin for 63781.....
14017	3715	Feed Regulator Roller and Screw Stud Nut Washer for 1953.....
14079	3731	Arch Clamp Frame Dowel Pin for 17969, 39251, 39256, 39471, 63728, 63735, 63820, 63839, 63854 and 63988.....
14224	—	Starting Lever Rock Shaft Chain, length 10¼ in., with 56864, for 63981.....
15072	7215	Bobbin Winder Bobbin Position Pin for 27538.....
15140	7214	Shuttle Bobbin Case Latch for 15141.....
15141	—	“ “ “ Hinge for 33942, Nos. 2973, 2974 and 15140.....
*15160	—	Oscillating Shaft Crank for 15161.....
*15161	—	Oscillating Shaft Crank complete for all machines except 68-32, Nos. 462c, 1519E, 15160 and 15171.....
15162	3702	Oscillating Shaft Crank complete for all machines except 68-32, Nos. 1519E, 15171, 15425 and two 462c.....
15163	—	Oscillating Shaft Crank for 15164.....
*15164	—	Oscillating Shaft Crank complete for 68-32 Machine, Nos. 462c, 1519E, 15183 and 15171.....
15165	7213	Oscillating Shaft Crank complete for 68-32 Machine, Nos. 1519E, 15171, 15426 and two 462c.....
15170	3702	Oscillating Shaft Crank Slide Block for 15171.....
15171	3702	Oscillating Shaft Crank Slide Block complete for 15161, 15162, 15164 and 15165, Nos. 226r, 1035c, 12424 and 15170.....
15261	7009	Protector Rod Collar with 237F, for 63753

NO.	PLATE	NAME
15261	7009	Protector Rod Spring Collar with 237F, for 63753.....
15278	7235	Shuttle Tension Spring for 33942.....
*15404	—	Trade Mark for 17701, 39279, 39282, 39422, 63804 and 63989 to 63992.....
15405	20333	Trade Mark Rivet for 17701, 39279, 39282, 39422, 63804 and 63989 to 63992.....
15425	—	Oscillating Shaft Crank for 15162.....
15426	—	“ “ “ “ 15165.....
16128	7242	Starting Lever Rock Shaft Hanger with two wood screws 1 in. No. 10, for 63981
16202	—	Tension Screw Stud 600c with 1560c, for 56791.....
16532	3722	Stop Cam Interlocking Rod Case Bracket Dowel Pin.....
*17701	—	Arm with 4449, 15404, 17844 and two each 164E and 15405, obsolete.....
17702	3728	Arm Shaft.....
17703	3711	“ “ Bushing (back).....
*17704	—	Bed for 68-1, 68-4, 68-6, 68-7, 68-9 to 68-12, 68-14 to 68-19, 68-21 to 68-23, 68-25, 68-26, 68-29 to 68-32, 68-34 and 68-36 to 68-38 Machines.....
17705	3720	Belt Shifter for 17847 and 17849, obsolete
17706	3704	Button Clamp (left) with 17723, for 17898.....
17707	3704	Button Clamp (right) with 17723, for 17898.....
17708	3710	Arch Clamp Foot Lifter with 17866, for 68-11, 68-34 and 68-38 Machines.....
17708	3710	Arch Clamp Lifter with 17866, for 68-27 Machine.....
17708	3710	Button Clamp Lifter with 17866, for 68-1, 68-4, 68-6, 68-7, 68-21, 68-25, 68-26, 68-29 and 68-30 Machines.....
17708	3710	Clamp Arm Lifter with 17866, for 68-17 Machine.....
17708	3710	Clamp Arm (upper) Lifter with 17866, for 68-12 Machine.....
17708	3710	Clamp Lifter with 17866, for 68-36 and 68-37 Machines.....
17708	3710	Smocking Attachment Lifter with 17866, for 68-31 Machine.....
17710	3704	Buckle Clamp Arm Hinge Plate for 68-22 Machine.....

NO.	PLATE	NAME
17710	3704	Button Clamp Arm Hinge Plate for 68-1, 68-4, 68-6, 68-7, 68-21, 68-25, 68-26, 68-29 and 68-30 Machines.....
17710	3704	Clamp Arm Hinge Plate for 68-19, 68-36 and 68-37 Machines.....
17711	3704	Button Clamp Arm Hook for 17901 and 39377.....
17711	3704	Clamp Arm Hook for 17901.....
17712	3710	Buckle Clamp Pressure Spring for 68-22 Machine.....
17712	3710	Button Clamp Pressure Spring for 68-1, 68-4, 68-6, 68-7, 68-21, 68-29 and 68-30 Machines.....
17712	3710	Clamp Pressure Spring for 68-6, 68-7, 68-17, 68-19, 68-36 and 68-37 Machines.....
17713	3710	Buckle Clamp Pressure Spring Bracket for 68-22 Machine.....
17713	3710	Button Clamp Pressure Spring Bracket for 68-1, 68-4, 68-6, 68-7, 68-21, 68-25, 68-26, 68-29 and 68-30 Machines.....
17713	3710	Clamp Pressure Spring Bracket for 17912, 17953, 17987 and 68-17, 68-19, 68-36 and 68-37 Machines.....
17714	3704	Buckle Clamp Pressure Spring Guide Block for 17927 and 63970.....
17714	3704	Button Clamp Pressure Spring Guide Block for 17901, 17927, 39377, 63739 and 63927.....
17714	3704	Clamp Pressure Spring Guide Block for 17901, 17908, 17927, 17947 and 63935..
17716	3705	Button Clamp Spreader for 17898 and 17904.....
17716	3705	Clamp Spreader for 39319 and 63939.....
17717	3705	Arch Clamp Spreader Lever for 39471.....
17717	3705	Buckle Clamp Spreader Lever for 63971
17717	3705	Button Clamp Spreader Lever for 17898, 17904, 63928 and 63929.....
17717	3705	Clamp Spreader Lever for 39319 and 63939
17718	3705	Arch Clamp Spreader Lever Locking Thumb Screw Washer for 39471.....
17718	3705	Buckle Clamp Buckle Stop Thumb Screw Washer for 63971.....
17718	3705	Buckle Clamp Spreader Lever Locking Thumb Screw Washer for 63971.....
17718	3705	Button Clamp Spreader Lever Locking Thumb Screw Washer for 17898, 17904, 63746, 63928 and 63929.....

NO.	PLATE	NAME
17718	3769	Button Clamp Stop (front) Lever Thumb Screw Washer for 39392.....
17718	3705	Clamp Spreader Lever Locking Thumb Screw Washer for 39319 and 63939.....
17718	3705	Clamp Spreader Stud Thumb Nut Washer for 17912.....
17718	3705	Clamp Stop Thumb Screw Washer for 63939.....
17719	3705	Buckle Clamp Spreader Spring for 63971
17719	3705	Button Clamp Spreader Spring for 17898, 17904, 63746, 63928 and 63929.....
17719	3769	Button Clamp Stop (front) Spring for 39392.....
17719	3705	Clamp Spreader Spring for 39319 and 63939.....
17720	3705	Arch Clamp Spreader Steady Pin for 39470.....
17720	3705	Buckle Clamp Spreader Steady Pin for 39367.....
17720	3705	Button Clamp Spreader Steady Pin for 17722, 17903, 18466, 39248 and 63745..
17720	3705	Clamp Arm Pin for 39337.....
17720	3705	" Spreader Steady Pin for 39318.....
17721	3705	Button Clamp Spring, for flat buttons, for 17898.....
17722	3705	Button Clamp Stop with two 17720, for 17898.....
17723	3704	Arch Clamp Stud for 39461 and 39462....
17723	3704	Buckle Clamp Stud for 39363 and 39364..
17723	3704	Button Clamp Stud for 17706, 17707, 17899, 17900, 18464, 18465, 39238, 39239, 63737 and 63738.....
17723	3704	Clamp Stud for 39314, 39315, 63933 and 63934.....
17724	3711	Face Plate for 63736.....
17725	—	Face Plate complete, Nos. 448c, 2107, 2127, 56791, 63736 and two 233j.....
17726	3714	Feed Across Connection Adjusting Stud
17727	3714	" " Knuckle Joint, obsolete....
17728	3714	" " " " Connection, obsolete.....
17729	3713	Feed Across Lever with 1185c and 1952...
17730	3714	" " " Ball Stud, obsolete....

NO.	PLATE	NAME
17731	3713	Feed Across Lever Bracket with 17732 and three 160j, for 68-1, 68-4, 68-6, 68-7, 68-9 to 68-12, 68-14 to 68-19, 68-22, 68-23, 68-25 to 68-27, 68-29 to 68-32, 68-34, 68-36 and 68-37 Machines.....
*17732	—	Feed Across Lever Bracket Cap for 17731 and 63963.....
17733	3714	Feed Across Lever Socket Bearing, obsolete.....
17734	3714	Feed Across Lever Socket Bearing Block (two pieces) obsolete.....
17735	3701	Feed Across Plate with 17741, for all machines except 68-28.....
17736	3713	Feed Across Regulator, for all machines except 68-27 and 68-28.....
17737	3714	Feed Across Lever Hinge Stud.....
17738	3715	“ “ Regulator Adjusting Screw Stud Nut Washer (steel).....
17739	3715	Feed Across Regulator Adjusting Stud Sleeve, obsolete.....
17740	3715	Feed Across Regulator Link, for all machines except 68-28.....
17741	3701	Belt Cover Bracket Stud for 39290.....
17741	3701	Feed Across Regulator Link Stud for 17735 and 39424.....
17742	3713	Feed Regulator with 1953, for 68-1, 68-4, 68-6, 68-7, 68-9 to 68-12, 68-14 to 68-19, 68-22, 68-23, 68-25 to 68-27, 68-29 to 68-32, 68-34 and 68-36 to 68-38 Machines.....
17743	3715	Feed Regulator Post for 39253, 39254, 39260, 39301, 39433, 63703 and 63833..
17744	3715	Feed Regulator Hinge Stud.....
17745	3715	“ “ Swivel for 68-1, 68-4, 68-6, 68-7, 68-9 to 68-12, 68-14 to 68-19, 68-22, 68-23, 68-25 to 68-27, 68-29 to 68-32, 68-34 and 68-36 to 68-38 Machines.....
17746	3719	Shuttle Race Back with 17747, for 63815.
17747	3719	“ “ Thread Guard Pin for 17746.....
17748	3722	Thread Eyelet (top of arm) obsolete.....
17749	3723	Throat Plate Extension for 17870, 17925, 39214, 39273 to 39275, 39292 to 39294, 39402, 39457, 63786 and 63791.....
17750	—	Knife Bar Extension 17820 with 17821 and two 17822.....

NO.	PLATE	NAME
17751	—	Feed Cam with two each 1192c, 17874 and four 190j, for 68-1 Machine.....
17754	—	Feed Cam with two each 1192c, 17874 and four 190j, for 68-4 Machine.....
17756	3712	Feed Cam with two each 1192c, 17874 and four 190j, for 68-6 and 68-26 Machines.....
17757	—	Feed Cam with two 1192c, three 17874 and six 190j, for 68-7, 68-25 and 68-31 Machines.....
17759	—	Feed Cam with 17874 and two each 190j and 1192c, for 68-9 Machine.....
17760	—	Feed Cam with 17874 and two each 190j and 1192c, for 68-10 Machine.....
17761	—	Feed Cam with two each 1192c, 17874 and four 190j, for 68-11, 68-12 and 68-38 Machines.....
17764	—	Feed Cam with 17874 and two each 190j and 1192c, for 68-14 Machine.....
17765	—	Feed Cam with two 1192c, three 17874 and six 190j, for 68-15 Machine.....
17766	—	Feed Cam with two each 1192c, 17874 and four 190j, for 68-16 Machine.....
17767	—	Feed Cam with two each 1192c, 17874 and four 190j, for 68-17 Machine.....
17768	—	Feed Cam with two 1192c and six each 190j and 17874, for 68-18 Machine.....
17769	—	Feed Cam with 17874 and two each 190j and 1192c, for 68-19 Machine.....
17770	—	Feed Cam with 17874 and two each 190j and 1192c, for 68-20 Machine.....
17771	—	Feed Cam with 17874 and two each 190j and 1192c, for 68-21 Machine.....
17772	—	Feed Cam with 17874 and two each 190j and 1192c, for 68-22 Machine.....
17773	—	Feed Cam with two 1192c and four each 190j and 17874, for 68-23 Machine.....
17774	—	Feed Cam with 17874 and two each 190j and 1192c, for 68-24 Machine.....
17779	—	Feed Cam with two 1192c and four each 190j and 17874, for 68-29 Machine.....
17780	—	Feed Cam with two each 1192c, 17874 and four 190j, for 68-30 Machine.....
17783	—	Feed Cam with 17874 and two each 190j and 1192c, for 68-33 Machine.....
17786	—	Feed Cam with 17874 and two each 190j and 1192c, for 68-36 Machine.....

NO.	PLATE	NAME
17787	—	Feed Cam with 17874 and two each 190r and 1192c, for 68-37 Machine.....
17796	3715	Feed Cam Driving Worm with 453c, for 68-1, 68-4, 68-6, 68-7 and 68-9 to 68-12 Machines, obsolete.....
17797	3713	Feed Cam Driving Worm Wheel with 453c, for 68-1, 68-4, 68-6, 68-7, 68-9 to 68-12, 68-15, 68-17 to 68-20, 68-22, 68-24 to 68-28, 68-31 to 68-34 and 68-38 Machines.....
17798	3713	Feed Cam Shaft, obsolete.....
17799	3713	" " " Bracket, obsolete.....
17800	3701	" Plate (thin) for flat buttons, for 68-1, 68-4, 68-6, 68-7, 68-29 and 68-30 Machines.....
17802	3701	Feed Plate Carrier Bar Block for 17987, 39253, 39254, 39260, 39360, 39433, 63703 and 63833.....
17803	3701	Feed Plate Carrier Bar Block Cover for 17969, 17987, 39251, 39256, 39337 to 39339, 39421, 39471, 39482, 63717, 63728, 63735, 63820, 63839, 63854 and 63988, and for 68-1, 68-4, 68-6, 68-7, 68-16, 68-19, 68-22, 68-25, 68-26, 68-29, 68-30, 68-36 and 68-37 Machines.....
17804	3701	Feed Plate Carrier Bar Block Rivet for 17987, 39253, 39254, 39260, 39360, 39433, 63703 and 63833.....
17805	3714	Feed Plate Carrier Bar Pivot Block...
17806	3701	" " Position Stud for 39253, 39254, 39260, 39360, 39433, 63703 and 63833.....
17806	3701	Feed Plate Rivet for 17987.....
17807	3717	Knife (needle thread) for 39488.....
17808	3717	" (shuttle thread) for 39488 and 63844.....
17809	3725	Knife Bar with 17813 and 17814, for 17816, obsolete.....
17810	3700	Knife Bar Cap (back).....
17811	3700	" " " (front).....
17812	3700	" " " (intermediate) obsolete....
17813	3725	" " Connection with 17815, for 17809, obsolete.....
17814	3700	Knife Bar Connection Rivet for 17809, 17913 and 63807.....
17815	3726	Knife Bar Connection Stud for 17813, obsolete.....

NO.	PLATE	NAME
17816	3726	Knife Bar Driving Lever with 17817 to 17819, for 17809, obsolete.....
Nos. 17817 TO 17819 FOR 17816, OBSOLETE		
17817	3700	Knife Bar Driving Lever Lock Stud.....
17818	3726	" " " " " " Spring.....
17819	3726	" " " " " " Stop Pin.....
17820	3716	Knife Bar Extension for 17750.....
17821	3717	" " Rack for 17750.....
17822	3717	" " Rivet for 17750.....
17822	20884	Thread Lubricator Oil Reservoir Rivet for 65091.....
17824	3720	Knife Cam Lever Bracket for 1197d, obsolete.....
17825	3717	Knife Holder with 17826, 17830 and two 7298, obsolete.....
17826	3717	Knife Holder Pinion for 17825 and 39269.....
17827	3717	" " Stud for 17828 and 39270.....
17828	3717	Knife Holder Pinion Stud Bracket with 17827, obsolete.....
17829	3717	Knife Thread Holder for 39488 and 63844.....
17830	3717	" " Position Pin for 17825 and 39269.....
17831	3716	Needle Bar with 237F, for all machines except 68-33.....
17834	3718	Needle Bar Thread Nipper Lever with 17835, for all machines except 68-33....
17835	3718	Needle Bar Thread Nipper Lever Bushing for 17834 and 63792.....
17836	3718	Needle Bar Thread Nipper Lever Spring, obsolete.....
17837	3716	Needle Bar Thread Nipper Rod.....
17838	3718	" " " " " Adjusting Stud.....
17839	3718	Needle Bar Thread Nipper Rod Arm with 196F.....
17840	3716	Needle Bar Thread Nipper Rod Support..
17841	3718	Presser Bar Collar with two 196F....
17842	3718	" " Guide Bracket with 453c..
17843	3711	" " Lifting Lever.....
17844	3711	" " " " Bracket for 17701, 39279, 39282, 39422, 63804 and 63989 to 63992.....
17845	3716	Presser Bar Lifting Lever Rod.....
17846	—	" " " " Chain.....

NO.	PLATE	NAME
17847	3720	Pulley (loose) 2½ in. diam., obsolete....
17848	3720	" " Bushing for 17955.....
17849	3720	" (tight) 2½ in. diam., with 2269, obsolete.....
17853	3720	Starting Lever for 39281, 39289, 63752 and 63754.....
17854	3721	Stop Cam for 17955.....
17855	3721	" " Interlocking Rod for 39405 and 63759.....
17858	3720	Stop Cam Interlocking Rod Case Extension for 164j and 1255j, obsolete.....
17859	3720	Stop Cam Interlocking Rod Case Socket Joint for 39281, 39289, 63752, 63754 and 63967.....
17860	3721	Stop Cam Interlocking Rod Case Spring for 39281 and 39289, obsolete.....
17861	3721	Stop Cam Interlocking Rod Case Stop Stud for 39281, 39289, 63752, 63754 and 63967.....
17862	3721	Stop Cam Interlocking Rod Case Stop Stud Spring for 39281, 39289, 63752, 63754 and 63967.....
17863	3721	Stop Cam Interlocking Rod Spring for 39405 and 63759.....
17864	3721	Stop Cam Interlocking Rod Stop for 39405 and 63759.....
17865	3710	Thread Wiper Body for 68-1, 68-4, 68-6, 68-7, 68-9 to 68-12, 68-14 to 68-24, 68-27, 68-29 to 68-31, 68-34 and 68-36 to 68-38 Machines.....
17866	3710	Thread Wiper Body Hook for 17708, 17958 and 39206.....
17867	3710	Thread Wiper Body Support for 68-1, 68-4, 68-6, 68-7, 68-9 to 68-12, 68-14 to 68-27, 68-29 to 68-31, 68-34 and 68-36 to 68-38 Machines.....
17868	3710	Thread Wiper Body Wire for 68-1, 68-4, 68-6, 68-7, 68-9 to 68-12, 68-14 to 68-24, 68-27, 68-29 to 68-31, 68-34 and 68-36 to 68-38 Machines.....
17869	3710	Thread Wiper Body Wire Screw Washer for 68-1, 68-4, 68-6, 68-7, 68-9 to 68-12, 68-14 to 68-27, 68-29 to 68-31, 68-34 and 68-36 to 68-38 Machines.....
17870	3723	Throat Plate with 17749, 17871 and two each 1208D and 50406D, for flat buttons, for all machines except 68-9, obsolete...

NO.	PLATE	NAME
17871	3723	Throat Plate Needle Hole Bushing for 17870, 39273 and 39292.....
17872	3721	Trip Lever for 39281, 39289, 63752, 63754 and 63967.....
17873	3721	Trip Lever Spring for 39281, 39289, 63752, 63754 and 63967.....
17874	3717	Tripping Point for 17751, 17754, 17756, 17757, 17759 to 17761, 17764 to 17774, 17779, 17780, 17783, 17786, 17787, 18398, 39430, 39473 and 63830.....
17875	7202	Table Bracket Machine Holder with 2809, 7263, 39484 and two wood screws 1¼ in. No. 10 (Attachments and Acces- sories).....
17876	3728	Starting Lever and Foot Lifter Treadle with 443c, for 17884.....
Nos. 17877 TO 17879 FOR 17880		
17877	3728	Starting Lever and Foot Lifter Treadle Pitman Rod (lower).....
17878	3728	Starting Lever and Foot Lifter Treadle Pitman Rod (upper).....
17879	3728	Starting Lever and Foot Lifter Treadle Pitman Rod Clamp with two 161e....
17880	3728	Starting Lever and Foot Lifter Treadle Pitman complete for 17885 and 17891, Nos. 17877 to 17879.....
17881	3716	Starting Lever and Foot Lifter Treadle Shaft for 17884.....
17881	3716	Starting Lever Treadle Shaft for 17945, obsolete.....
17882	3718	Starting Lever and Foot Lifter Treadle Spring for 17884 and 17945.....
17883	3728	Starting Lever and Foot Lifter Treadle Stand for 17884 and 17945.....
17884	—	Starting Lever and Foot Lifter Treadle complete for 17885, Nos. 17876, 17881 to 17883 and two wood screws 1 in. No. 10.....
17885	—	Starting Lever and Foot Lifter Treadle and Pitman complete, for power table, Nos. 17880 and 17884.....
17886	3716	Starting Lever Pitman.....
17891	—	Starting Lever Treadle and Pitman com- plete, Nos. 17880 and 17945, obsolete...
17892	3728	Table Belt Guide Bracket with two 153e, for 39221.....

NO.	PLATE	NAME
17893	3728	Table Belt Guide Pulley for 39221.....
17896	3718	“ “ “ “ Shaft Plug for 39219 and 39220.....
17898	3703	Button Clamp (universal) complete, for 14 to 36 line buttons, for 68-1, 68-4, 68-6, 68-7, 68-29 and 68-30 Machines, Nos. 236r, 1180r, 1181r, 1182r, 1183r, 17706, 17707, 17716 to 17719, 17721 or 17938, 17722, 17901; 50237k and two 1175r.....
17899	3708	Button Clamp (left) with 17723, for 17904.....
17900	3708	Button Clamp (right) with 17723, for 17904.....
17901	3704	Button Clamp Arm with 17711, 17714 and 23227, for 17898 and 17904.....
17901	3704	Clamp Arm with 17711, 17714 and 23227, for 39319.....
17902	3708	Button Clamp Spring, for flat buttons, for 17904.....
17903	3708	Button Clamp Stop with two 17720, for 17904.....
17904	—	Button Clamp (universal) complete, for 26 to 46 line buttons, for 68-1, 68-4, 68-6, 68-7, 68-29 and 68-30 Machines, Nos. 236r, 1180r, 1181r, 1182r, 1183r, 17716 to 17719, 17899 to 17901, 17902 or 17939, 17903, 50237k and two 1175r..
17905	3727	Wrench for 1178, 1654, 1655, 1676 and 1681 (Attachments and Accessories)
Nos. 17906 to 17911 for 17912		
17906	3709	Clamp (left) with 23219.....
17907	3709	“ (right).....
17908	3709	“ Arm with 17714 and 63788.....
17909	3709	“ Spreader Spring.....
17910	3709	“ Spring.....
17911	3709	“ Hook Stop.....
17912	—	Clamp complete, for hooks and eyes, for 68-6 and 68-7 Machines, Nos. 1182r, 1219r, 1657r, 17718, 17906 to 17911 and two each 1175r and 1208r.....
17913	3716	Knife Bar with 17914 and two 17814, obsolete.....
17914	3700	Knife Bar Connection 63808 with 17917, for 17913, obsolete.....

NO.	PLATE	NAME
17915	3700	Knife Bar Connection Slide Block for 17917 and 63809.....
17916	3700	Knife Bar Connection Slide Block Stud for 17917, obsolete.....
17917	—	Knife Bar Connection Slide Block 17915 with 17916, for 17914, obsolete.....
17919	3700	Knife Bar Driving Lever Lock Stud Spring for 39297.....
17921	3717	Knife Bar Spring, obsolete.....
17922	3717	“ “ “ Stud for 17812 and 17913, obsolete.....
17923	3701	Feed Plate (thick) for round bottom buttons, for 68-1, 68-4, 68-6, 68-7, 68-29 and 68-30 Machines.....
17924	3723	Throat Plate Needle Hole Bushing for 17925, 39274 and 39293.....
17925	—	Throat Plate with 17749, 17924 and two each 1208r and 50406r, for round bottom buttons, for 68-1, 68-4, 68-6 and 68-7 Machines, obsolete.....
17926	3706	Button Clamp with 1220r and 17928, for 17931.....
17927	3706	Buckle Clamp Arm with 17714 and 63788, for 39372.....
17927	3706	Button Clamp Arm with 17714 and 63788, for 17932 and 17937.....
17927	3706	Clamp Arm with 17714 and 63788, for 39323.....
17928	3706	Buckle Clamp Position Stud for 39371....
17928	3706	Button Clamp Position Stud for 17926 and 17933.....
17928	3706	Clamp Position Stud for 39320.....
17929	3706	Button Clamp Spring, for flat buttons, for 17931.....
17930	3706	Button Clamp Spring, for stud back buttons, for 17931.....
17931	—	Button Clamp (end opening) complete for 17932, Nos. 17926, 17929 or 17930 and two 1208r.....
17932	—	Button Clamp (end opening) with Arm complete, for 68-1, 68-4, 68-6 and 68-7 Machines, Nos. 1656r, 17927 and 17931.....
Nos. 17933 to 17935 for 17936		
17933	3707	Button Clamp with 1220r and 17928.
17934	3707	“ “ Spring, for flat buttons

NUMERICAL LIST OF PARTS

NO.	PLATE	NAME
17935	3707	Button Clamp Spring, for stud back buttons.....
17936	—	Button Clamp (side opening) complete for 17937, Nos. 17933, 17934 or 17935 and two 1208j.....
17937	—	Button Clamp (side opening) with Arm complete, for 68-1, 68-4, 68-6, and 68-7 Machines, Nos. 1656j, 17927 and 17936
17938	3705	Button Clamp Spring, for stud back buttons, for 17898.....
17939	3708	Button Clamp Spring, for stud back buttons, for 17904.....
17940	3725	Belt Shifter, obsolete.....
17941	3725	Pulley (loose) 2½ in. diam., for 17955, obsolete.....
17942	3725	Pulley (tight) 2½ in. diam., with 2269, for 17955.....
17943	3741	Starting Lever Treadle with 196r and 443c, for 17945, obsolete.....
17944	3741	Starting Lever Treadle Extension for 17945, obsolete.....
17945	—	Starting Lever Treadle complete for 17891, Nos. 17881 to 17883, 17943, 17944 and two wood screws 1 in. No. 10, obsolete.
17946	3729	Clamp with 17948, for 17953.....
17947	3729	“ Arm with 17714 and 63788, for 17953 and 39226.....
17948	3729	Clamp Hinge Stud for 17946 and 39225..
Nos. 17949 TO 17952 FOR 17953 AND 39226		
17949	3729	Clamp Hinge Stud Pin.....
17950	3729	“ Leveling Thumb Screw Stop Bracket
17951	3729	“ Stretching Ring.....
17952	3729	“ “ “ Spring.....
17953	—	Clamp complete, for tying French knots, for 68-6 Machine, Nos. 578k, 1263j, 17946, 17947, 17949 to 17952, two 1264j and three 220j.....
17954	3735	Feed Plate for 17953.....
17955	—	Pulleys complete, Nos. 1202r, 1206c, 17848, 17854, 17942 and 63975.....
17957	3731	Arch Clamp Foot with 17959, for 39251..
17958	3733	“ “ “ Lifter with 17866, for 68-10, 68-20 and 68-24 Machines.....
17958	3733	Arch Clamp Lifter with 17866, for 68-33 Machine.....

NUMERICAL LIST OF PARTS

NO.	PLATE	NAME
17958	3733	Buckle Clamp Lifter with 17866, for 68-22 Machine.....
17958	3733	Clamp Arm Lifter with 17866, for 68-14 to 68-16, 68-18 and 68-23 Machines....
17958	3733	Clamp Lifter with 17866, for 68-19 Machine.....
17959	3731	Arch Clamp Foot Lifting Stud for 17957, 17964, 17965, 17972, 39215, 63817 and 63984.....
17960	3731	Arch Clamp Foot Plate for 39251 and 39256.....
17963	3731	Feed Plate for 39251.....
17964	3733	Arch Clamp Foot (left) with 17959, for 17969 and 63839.....
17965	3733	Arch Clamp Foot (right) with 17959, for 17969 and 63839.....
17966	3733	Arch Clamp Foot Plate for 17969.....
17967	3733	“ “ “ Spring Connection for 17969 and 63839.....
17968	3732	Arch Clamp Frame for 17969 and 63839..
17969	—	Arch Clamp complete for 68-10 Machine, Nos. 1654c, 17964 to 17968, 17970, 39254, 39302, two each 1175j, 1177j, 1186c, 1651j, 14079, 17803 and five 217r.....
17970	3740	Feed Plate for 17969, 63839 and 68-19 Machine.....
*17971	3736	Feed Plate Carrier Bar for 39254.....
17972	3735	Arch Clamp Foot with 17959, for 39256..
17975	3735	Feed Plate for 39256.....
17976	3737	Clamp Arm (lower) left, for 17987.....
17977	3737	“ “ “ right, for 17987.....
17978	3737	“ “ “ Bracket for 63781.....
17979	3738	“ “ (upper) left, with 17986 and 39257, for 17987.....
17980	3738	Clamp Arm (upper) right, with 17986 and 39257, for 17987.....
17981	3737	Clamp Arm (upper) Bracket for 63781....
Nos. 17982 TO 17984 FOR 17987		
17982	3738	Clamp Pressure Spring.....
17983	3737	“ Spreader Lever.....
17984	3738	“ “ “ Friction Washer
17985	3738	“ “ “ Hinge Stud for 39301.....
17986	3738	Clamp Spreader Stud for 17979 and 17980

NO.	PLATE	NAME
17987	—	Clamp complete for 68-12 Machine, Nos. 181j, 957k, 1177j, 1178j, 17713, 17802, 17804, 17976, 17977, 17979, 17980, 17982 to 17984, 17988, 17989, 20437, 39301, 63781, two each 1186c, 1651j, 7401, 7476, 17803 and four each 90j and 17806.....
17988	3737	Feed Plate (left) for 17987.....
17989	3737	" " (right) for 17987.....
*17990	3736	" " Carrier Bar for 39301.....
17992	3740	Clamp Arm (lower) Hook for 63811.....
17996	3726	Feed Cam Driving Worm with 453c, for 68-14 Machine, obsolete.....
17997	3725	Feed Cam Driving Worm Wheel with 453c, for 68-14 and 68-21 Machines.....
17999	3739	Clamp Arm with two 39257, for 39338....
18368	3714	Feed Plate Carrier Bar Plate for 39253, 39254, 39260, 39301, 39360, 39433 and 63703.....
18384	3753	Feed Cam Driving Worm Wheel Pin....
18384	3753	" " Pin.....
18390	7214	" Plate Carrier Bar Plate for 63833, obsolete.....
18392	7211	Thread Take-up Cam 55302 with 446c, for 68-32 Machine.....
*18393	3752	Thread Take-up Lever with 1822, for 55283.....
18398	—	Feed Cam with 17874 and two each 190j and 1192c, for 68-32 Machine.....
18415	3746	Feed Cam Driving Worm with 1441c and 1442c, for 68-1, 68-4, 68-6, 68-7, 68-9 to 68-12, 68-15, 68-17 to 68-20, 68-22, 68-24 to 68-28, 68-31 to 68-34 and 68-38 Machines.....
18416	3712	Feed Cam Shaft, obsolete.....
18417	3712	" " " Bracket, obsolete.....
18433	3762	Arch Clamp Foot Plate for 63728.....
18434	3762	" " " Spring Connection for 63728.....
18441	3752	Stop Cam Interlocking Rod Case Bracket for 39281, obsolete.....
18443	3754	Stop Cam Interlocking Rod Case Wearing Block for 39280, 39345 and 63978.....
18450	7210	Feed Plate for 39471.....
		Nos. 18464 to 18466 for 63929
18464	3764	Button Clamp (left) with 9311 and 17723.

NO.	PLATE	NAME
18465	3764	Button Clamp (right) with 9311 and 17723
18466	3764	" " Stop with two 17720.....
18468	3764	Feed Plate for 68-21 Machine.....
18471	3759	Knife Cam Lever Hinge Screw Bushing for 18472.....
18472	—	Knife Cam Lever Hinge Screw Bushing 18471 with 50029c.....
18477	3767	Arch Clamp Foot Plate for 63735.....
18477	3767	" " Ring Holder Shank Plate for 63854.....
18480	3739	Arch Clamp Foot Spring (heavy) for 68-24 Machine.....
18480	3739	Arch Clamp Spring for 63854.....
18488	3759	Feed Regulator Post for 39360.....
18489	3759	" " " Guide for 39360.....
18498	7202	Belt Cover.....
19793	3746	Knife Bar Stop Block Dowel Pin.....
19793	3746	" Cam Lever Slide Steady Pin for 39329.....
20437	20333	Buckle Clamp Pressure Spring Screw Washer for 68-22 Machine.....
20437	20333	Button Clamp Pressure Spring Screw Washer for 68-1, 68-4, 68-6, 68-7, 68-21, 68-25, 68-26, 68-29 and 68-30 Machines
20437	20333	Clamp Pressure Spring Screw Washer for 17987 and for 68-17, 68-19, 68-36 and 68-37 Machines.....
21202	20884	Thread Lubricator Bracket Screw Friction Washer for 65092.....
21629	3718	Needle Bar Connecting Stud with 155c, for 63756.....
21678	3754	Hand Stop Lever Rod Collar with 1019c, for 68-10 and 68-32 Machines.....
22003	3727	Wrench for 1550 and 1651 (Attachments and Accessories).....
22232	7213	Smocking Indicator (left) Hinge Screw Friction Washer for 63717.....
22232	7213	Smocking Indicator (right) Hinge Screw Friction Washer for 63717.....
23219	3709	Clamp Spring Steady Pin for 17906.....
23227	3705	Button Clamp Spring Steady Pin for 17901
23375	3743	Belt Cover Hinge Block with 460c, obsolete.....
23376	3743	Belt Cover Hinge Block Pin, obsolete....
24122	3754	Hand Stop Lever Rod Spring for 68-10 and 68-32 Machines.....

NO.	PLATE	NAME
24412	7214	Shuttle Bobbin Case Position Plate for 63842
26026	3727	Screw Driver, medium (Attachments and Accessories)
26069	—	Tape Holder Disc Hub for 26916
26073	20333	" " Tension Adjusting Collar with 286 _n , for 28807
26485	3727	Screw Driver, small (Attachments and Accessories)
26910	3799	Tape Holder Bracket Wire for 28806
26914	3799	" " Disc, 6 in., for 28806 and 26916
26916	3799	Tape Holder Disc complete for 28807, Nos. 26069 and 26914
26918	3799	Tape Holder Tape Guide for 28806
27305	3781	Bobbin Winder Spindle for 41713
27321	3781	" " Frame for 41604 and 41713
27326	3781	" " Stop Latch for 41713
27328	20334	" " " " 41604
27538	20334	" " Spindle 27849 with 15072, 27850 and 41828, for 41604
27659	7213	Smocking Clamping Blade Holder Hinge Pin Collar with 237 _k , for 63717
27662	3727	Wrench for 1254 and 1508 (Attachments and Accessories)
27683	7242	Starting Lever Rock Shaft Arm with two 356 _c , for 63981
27739	7234	Thread Unwinder Thread Cone (wood) for large cones, for 225258
*27849	—	Bobbin Winder Spindle for 27538
*27850	—	" " " Collar for 27538
27916	3781	" " Brake (leather) for 41598
28084	3781	" " " Rivet for 41598
28806	—	Tape Holder Bracket Wire complete for 28807, Nos. 26910, 26914 and 26918
28807	3799	Tape Holder (straight) 6 in. disc, complete for 68-28 Machine, Nos. 13211, 26073, 26916 and 28806
32134	20334	Starting Lever Rock Shaft Spring for 63981
32675	20333	Presser Bar Spring
33941	—	Shuttle Bobbin Case for 33942
33942	7235	Shuttle Bobbin Case complete for 63535, Nos. 591 _f , 592 _e , 2523, 2975, 7553, 15141, 15278 and 33941
36697	5697	Guide for 68-27 Machine
36698	5697	" Pointer for 68-27 Machine

NO.	PLATE	NAME
39201	3725	Belt Shifter, obsolete
39202	3725	Stop Cam Interlocking Rod Case, obsolete
*39203	3718	Needle Bar Connecting Link for 63756
39204	3711	Thread Take-up Cam 63749 with 446 _c , for all machines except 68-21 and 68-32
39205	3743	Guide with 460 _c , for 17953
39206	3731	Arch Clamp Foot Lifter with 17866, for 68-9 Machine
39209	3746	Shuttle Driver with 662 _n , 39210 and two 457 _c , for purl stitch, for all machines except 68-28, 68-32 and 68-38
39210	3746	Shuttle Driver Thread Pull-off, for purl stitch, for 39209
39211	3746	Feed Cam Driving Worm with 1441 _c and 1442 _c , for 68-16, 68-23, 68-29, 68-30, 68-36 and 68-37 Machines
39212	3743	Feed Cam Driving Worm Wheel with 453 _c , for 68-16, 68-23, 68-29, 68-30, 68-36 and 68-37 Machines
39213	3731	Throat Plate Needle Hole Bushing for 39214, 39275, 39294 and 39457
39214	—	Throat Plate with 17749, 39213 and two each 1208 _d and 50406 _d , for 68-9 Machine, obsolete
39215	3745	Arch Clamp Foot with 17959, 39216, 39217 and two 233 _j , for 68-11 Machine
39216	3745	Arch Clamp Foot Yielding Presser Spring (back) for 39215
39217	3745	Arch Clamp Foot Yielding Presser Spring (front) for 39215
Nos. 39218 to 39220 for 39221		
39218	3728	Table Belt Guide Belt Guide with two 168 _E
39219	3728	Table Belt Guide Pulley Shaft (long) with 17896 and 63973
39220	3728	Table Belt Guide Pulley Shaft (short) with 17896 and 63974
39221	—	Table Belt Guide complete, Nos. 17892, 39219, 39220, two each 17893, 39218 and three wood screws 1¼ in. No. 12
39222	3725	Belt Shifter for 39405 and 63759
39223	3726	" " Clamp for 39405 and 63759
39225	3744	Clamp with 17948, for 39226
39226	—	Clamp complete, for 68-17 Machine, Nos. 578 _k , 1263 _j , 17947, 17949 to 17952, 39225, two 1264 _j and three 220 _j

NO.	PLATE	NAME
39227	3744	Feed Plate for 68-17 Machine.....
39230	3743	Belt Cover Bracket, obsolete.....
39231	3746	Feed Cam Driving Worm with 1441c and 1442c, for 68-14 and 68-21 Machines...
39232	3749	Bed Frame Side Cover for 39233.....
39233	3749	" " with 39232, two each 9261, 39325, 39483 and four wood screws 1 1/4 in. No. 12.....
39234	3750	Drip Pan for 39233.....
39235	3758	Knife Cam Lever Body for 39409.....
39238	3747	Button Clamp (left) with 9311 and 17723, for 63928.....
39239	3747	Button Clamp (right) with 9311 and 17723, for 63928.....
39241	3748	Buckle Clamp Pressure Spring for 68-22 Machine.....
39241	3748	Button Clamp Pressure Spring for 68-1, 68-4, 68-6 and 68-7 Machines.....
39242	3748	Buckle Clamp Spreader for 63971.....
39242	3748	Button Clamp Spreader for 63746, 63928 and 63929.....
39243	3748	Arch Clamp Spreader Spring for 39471.....
39244	3747	Button Clamp Spring (left) for flat buttons, for 63928 and 63929.....
39245	3747	Button Clamp Spring (right) for flat buttons, for 63928 and 63929.....
39246	3748	Button Clamp Spring (left) for stud back buttons, for 63928 and 63929.....
39247	3748	Button Clamp Spring (right) for stud back buttons, for 63928 and 63929.....
39248	3748	Button Clamp Stop with two 17720, for 63928.....
39250	3742	Arch Clamp Frame for 39251.....
39251	—	Arch Clamp complete for 68-9 Machine, Nos. 1175j, 1654c, 17957, 17960, 17963, 39250, 39253, 39303, two each 181j, 1186c, 1651j, 14079, 17803 and five 217j
*39252	3743	Feed Plate Carrier Bar for 39253.....
39253	—	" " " " 39252 with 934j, 1195E, 8505, 17743, 17802, 17804, 18368, two 7476 and four 17806, for 39251, 39256, 39471, 63728 and 63988.....
39254	—	Feed Plate Carrier Bar 17971 with 934j, 1195E, 8505, 17743, 17802, 17804, 18368, two 7476 and four 17806, for 17969 and 63839.....
39255	3742	Arch Clamp Frame for 39256.....

NO.	PLATE	NAME
39256	—	Arch Clamp complete for 68-11 Machine, Nos. 1175j, 1654c, 17960, 17972, 17975, 39253, 39255, 39303, two each 181j, 1186c, 1651j, 14079, 17803 and five 217j
39257	3745	Clamp Arm Hook for 17999 and 39326...
39257	3745	" " (upper) Hook for 17979 and 17980.....
39258	3745	Feed Plate (thin) for 39338.....
*39259	3716	" " Carrier Bar for 39260.....
39260	—	" " " " 39259 with 934j, 1195E, 8505, 17743, 17802, 17804, 18368, two 7476 and four 17806, for 39337 to 39339 and 68-1, 68-4, 68-6, 68-7, 68-17, 68-19, 68-21, 68-22, 68-25, 68-26, 68-29, 68-30, 68-36 and 68-37 Machines.....
39262	3754	Knife Bar Cap (intermediate) for 39263..
39263	—	" " " " 39262 with 1328E, 1517E, 39264 and 39265.....
39264	3754	Knife Bar Cap (intermediate) Stop Pin for 39263.....
39265	3754	Knife Bar Cap (intermediate) Stop Pin Spring for 39263.....
39269	3755	Knife Holder 68710 with 1336c, 17826, 17830 and two 7298, for 39488 and 63844
39270	3755	Knife Holder Pinion Stud Bracket with 17827, for 39406, 39474, 39475, 39477, 63787, 63794, 63843 and 63845.....
39271	3755	Knife Thread Retainer with 39277 and two 39278, obsolete.....
39272	3753	Knife Thread Retainer Stud for 39269, obsolete.....
39273	3755	Throat Plate with 17749, 17871 and two each 1208D and 50406D, for 39271, for flat buttons, for 68-1, 68-4, 68-6, 68-7, 68-10 to 68-12 and 68-14 to 68-17 Machines, obsolete.....
39274	—	Throat Plate with 17749, 17924 and two each 1208D and 50406D, for 39271, for round bottom buttons, for 68-1, 68-4, 68-6 and 68-7 Machines, obsolete.....
39275	—	Throat Plate with 17749, 39213 and two each 1208D and 50406D, for 39271, for 68-9 Machine, obsolete.....
39276	3754	Needle Bar Thread Nipper Lever Spring for all machines except 68-33.....

NO.	PLATE	NAME
39277	3755	Knife Thread Retainer Finger for 39271 and 39291.....
39278	3755	Knife Thread Retainer Finger Rivet for 39271 and 39291.....
*39279	—	Arm with 4449, 15404, 17844 and two each 164E and 15405, for 68-1, 68-4, 68-6, 68-7, 68-9, 68-11, 68-12, 68-14 to 68-27, 68-29 to 68-31, 68-34 and 68-36 to 68-38 Machines, obsolete.....
39280	3743	Stop Cam Interlocking Rod Case with 18443 and two 193J, for 63759, obsolete
39281	—	Stop Cam Interlocking Rod Case Bracket complete, for all machines except 68-10, Nos. 1182E, 1196C, 1204E, 1254C, 1262C, 1508E, 1662C, 17853, 17859 to 17862, 17872, 17873, 18441, 63759 and two 898D, obsolete.....
Nos. 39282 to 39287 FOR 68-10 AND 68-32 MACHINES		
*39282	—	Arm with 4449, 15404, 17844 and two each 164E and 15405, obsolete.....
39283	3754	Hand Stop Lever.....
39284	3741	" " " Rod.....
39285	3754	" " " " Connection.....
39286	3754	" " " " Guide Stud (back)
39287	3754	" " " " " (front)
39288	3752	Stop Cam Interlocking Rod Case Bracket for 17860, for 39289, obsolete.....
39289	—	Stop Cam Interlocking Rod Case Bracket complete for 68-10 Machine, Nos. 1182E, 1196C, 1204E, 1254C, 1262C, 1508E, 1662C, 17853, 17859 to 17862, 17872, 17873, 39288, 63759 and two 898D, obsolete.....
39290	3743	Belt Cover Bracket with 184E and 17741.
39291	3756	Knife Thread Retainer with 39277 and two 39278, for 39406, 39474, 39475, 39477, 63787, 63794, 63843 and 63845..
39292	3756	Throat Plate 63997 with 17749, 17871, and two each 1208D and 50406D, for flat buttons, for 39406.....
39293	—	Throat Plate 63997 with 17749, 17924 and two each 1208D and 50406D, for round bottom buttons, for 39475.....
39294	—	Throat Plate 63997 with 17749, 39213 and two each 1208D and 50406D, for 39474

NO.	PLATE	NAME
*39295	—	Shuttle Body with 398E, 2082, 2084, 2211 and two 2212, for 39296.....
39296	3702	Shuttle complete for all machines except 68-32, Nos. 2073, 2076, 39295 and 44001
39297	3753	Knife Bar Driving Lever with 190J, 1420E, 17919 and 39298.....
39298	3753	Knife Bar Driving Lever Lock Stud for 39297.....
39299	3752	Knife Bar 63807 with 704c and 39300....
39300	3754	" " Stop Block for 39299.....
39301	—	Feed Plate Carrier Bar 17990 with 934J, 17743, 17985 and 18368, for 17987.....
39302	3731	Arch Clamp Foot Spring for 17969, 63728 and 63839.....
39303	3731	Arch Clamp Foot Spring for 39251 and 39256.....
39304	3744	Feed Plate for 39337.....
39307	3762	Arch Clamp Lifting Stud for 39465, 63770 and 63771.....
39309	3758	Feed Across Lever Bracket with 39310 and three 160J, for 68-20, 68-21, 68-24, 68-28 and 68-33 Machines.....
*39310	—	Feed Across Lever Bracket Cap for 39309
39311	3762	" Plate for 63728.....
39312	3758	" Regulator with 1953, for 68-20, 68-21 and 68-28 Machines.....
39313	3759	Feed Regulator Swivel for 68-20, 68-21, 68-24, 68-28 and 68-33 Machines.....
39314	3757	Clamp (left) with 17723, 39316 and two 9558, for 39319.....
39315	3757	Clamp (right) with 17723, 39317 and two 9558, for 39319.....
39316	3757	Clamp Buckle Stop (left) for 39314.....
39317	3757	" " (right) for 39315.....
39318	3757	" Spreader Holder with two 17720, for 39319 and 63939.....
39319	—	Clamp complete, for truss buckles, for 68-19 Machine, Nos. 1180J, 1181J, 1182J, 1183J, 17716 to 17719, 17901, 39314, 39315, 39318, 50237K and two 1175J..
39320	3785	Clamp with 1220E and 17928, for 39322...
39321	3785	" Spring for 39322.....
39322	—	Clamp complete, for safety pin tubes, for 39323, Nos. 39320, 39321 and two 1208J
39323	—	Clamp with Arm complete for 68-19 Machine, Nos. 1656J, 17927 and 39322....

NO.	PLATE	NAME
39324	3752	Thread Take-up Cam with 446c, for 68-21 Machine.....
39325	3746	Bed Frame Hinge Connection for 39233...
39326	3739	Clamp Arm with two 39257, for 39339....
39328	3759	Feed Plate for 39339.....
39329	3758	Knife Cam Lever complete, Nos. 19793 and 39409.....
39330	3759	Knife Cam Lever Slide with 1980, for 39460.....
39331	3759	Knife Cam Lever Slide Screw Washer for 39460.....
39332	3758	Knife Cam Lever Bracket with 1177j.....
Nos. 39333 to 39335 FOR 39336		
39333	3761	Clamp Arm Bracket.....
39334	3761	" " " Hinge Block.....
39335	3761	" " " Screw Plate.....
39336	3761	Clamp Arm Bracket (adjustable) complete for 39337 to 39339, Nos. 129j, 1178j, 1300j, 1654c, 39333 to 39335 and 50048j
39337	—	Clamp complete for 68-14 and 68-16 Machines, Nos. 1654c, 17720, 39260, 39304, 39336, 63811, 63812 and two each 1186c, 1651j and 17803.....
39338	—	Clamp complete for 68-15 and 68-18 Machines, Nos. 1654c, 17999, 39258, 39260, 39336 and two each 1186c, 1651j and 17803.....
39339	—	Clamp complete for 68-23 Machine, Nos. 1654c, 39260, 39326, 39328, 39336 and two each 1186c, 1651j and 17803.....
39340	3757	Button Clamp Spring for 39341.....
39341	—	" " " 39340 with 39342, for flat or stud back buttons, for 17904..
39342	3757	Button Clamp Spring Plate for 39341.....
39343	3760	Stop Cam Interlocking Rod Case Spring (flat) for 39347, 39349 and 63968.....
39344	3759	Stop Cam Interlocking Rod Case Spring Bracket with 1520E and 50682c, for 39347, 39349 and 63968.....
39345	3760	Stop Cam Interlocking Rod Case 63945, with 18443 and two 193j, for 39405, obsolete.....
39346	3760	Stop Cam Interlocking Rod Case Bracket for 63754 and 63967.....

NO.	PLATE	NAME
39347	—	Stop Cam Interlocking Rod Case Bracket 63754 with 39343, 39344 and two 1186j, for all machines except 68-10, 68-32 and 68-38.....
39348	3760	Stop Cam Interlocking Rod Case Bracket for 63752.....
39349	—	Stop Cam Interlocking Rod Case Bracket 63752 with 39343, 39344 and two 1186j, for 68-10 and 68-32 Machines.....
39350	3743	Needle Bar Thread Nipper Driving Lever (adjustable) with 39351 and two 335j..
39351	3759	Needle Bar Thread Nipper Driving Lever Extension for 39350.....
39352	3743	Needle Bar Thread Nipper Driving Lever Spring.....
39353	3767	Arch Clamp Foot (left) for 63729.....
39355	3767	" " " (right) for 63730.....
39358	3767	Feed Plate for 63735.....
*39359	3739	" " " Carrier Bar for 39360.....
39360	—	" " " " 39359 with 810D, 934j, 1195E, 8505, 17802, 17804, 18368, 18488, 18489, two 7476 and four 17806, for 63735 and 63854.....
39361	3758	Feed Regulator with 1953, for 68-24 and 68-33 Machines.....
39362	—	Feed Plate (thick) for 68-15 and 68-18 Machines.....
39363	3765	Buckle Clamp (left) with 9311 and 17723, for 63971.....
39364	3765	Buckle Clamp (right) with 9311 and 17723, for 63971.....
Nos. 39366 to 39369 FOR 63971		
39366	3766	Buckle Clamp Buckle Stop.....
39367	3764	" " " Spreader Holder with two 17720.....
39368	3765	Buckle Clamp Spring (left).....
39369	3765	" " " (right).....
39371	3764	" " " with 1220E and 17928, for 39372.....
39372	—	Buckle Clamp complete, for buckles with tongue, for 68-22 Machine, Nos. 1656j, 17927 and 39371.....
39373	3766	Feed Plate (thick) for 68-22 Machine.....
Nos. 39375 to 39378 FOR 39392		
39375	3769	Button Clamp (left).....

NO.	PLATE	NAME
39376	3769	Button Clamp (right).....
39377	3768	" " Arm with 17711 and 17714
39378	3769	" " Foot.....
39379	3770	" " Pressure Spring for 68-25 and 68-26 Machines.....

Nos. 39380 to 39390 FOR 39392

39380	3769	Button Clamp Spreader Link (left)....
39381	3769	" " " " (right)....
39382	3769	" " " " Thumb Screw Block.....
39383	3769	Button Clamp Stop (front).....
39384	3769	" " " " Arm.....
39385	3769	" " " " " Holder
39386	3769	" " " " " " "

Plate.....

39387	3769	Button Clamp Stop (front) Lever.....
39388	3769	" " " (upper).....
39389	3770	" " " " Lever.....
39390	3770	" " " " Regulator....
39391	3770	" " " " Releasing Arm for 68-25 and 68-26 Machines.....

39392	—	Button Clamp complete, for self-shank buttons, for 68-25 and 68-26 Machines, Nos. 90j, 176k, 207j, 714j, 1127j, 1145j, 1180j, 1263j, 1302j, 5569, 17718, 17719, 39375 to 39378, 39380 to 39390, two 1607j and three each 105j, 233j and 1175j.....
-------	---	--

39393	3771	Feed Plate with 39394 and two 39395, for 68-25 and 68-26 Machines.....
-------	------	---

39394	3771	Feed Plate Block for 39393.....
39395	3771	" " " Rivet for 39393.....

Nos. 39396 to 39401 FOR 68-25 AND
68-26 MACHINES

39396	3770	Tension Releaser.....
39397	3770	" " Bracket with 39399.....
39398	3770	Thread Wiper Body.....
39399	3770	" " " Stud for 39397.....
39400	3770	" " " Support Extension...
39401	3770	" " " Wire.....
39402	3771	Throat Plate with 17749, 39403 and two each 1208d and 50406d, for 63843.....
39403	3771	Throat Plate Needle Hole Bushing for 39402.....

NO.	PLATE	NAME
*39405	—	Stop Cam Interlocking Rod Case 63993 with 1318d, 17855, 17863, 17864 and 39222, for 63752, 63754 and 63967.....
39406	—	Throat Plate 39292 with 1698e, 39270, 39291, 39488 and 50018r, for 68-1, 68-4, 68-6, 68-7, 68-10 to 68-12, 68-14 to 68-19, 68-22 to 68-24, 68-27, 68-29 to 68-31, 68-34 and 68-36 to 68-38 Machines.....
39409	—	Knife Cam Lever Body 39235 with 39460, for 39329.....
39410	3786	Arch Clamp Check for 39421 and 39482..
39411	3786	" " " Lifting Stud for 39412
39411	3786	" " Foot Lifting Stud for 39418..
39412	3786	" " Check Shank with 39411, for 39421 and 39482.....
39413	3786	Arch Clamp Check Shield for 39421 and 63813.....
39414	3789	Arch Clamp Check Spring for 39421 and 39482.....
39415	3789	Arch Clamp Foot for 39421 and 63813....
39416	3786	" " " Lifter for 68-28 Ma- chine, obsolete.....
39417	7204	Arch Clamp Foot Plate with 1607e and 2000, for 39421, obsolete.....
Nos. 39418 to 39420 FOR 39421 AND 39482		
39418	3787	Arch Clamp Foot Shank with 39411.....
39419	3789	" " " Spring.....
39420	3789	" " " Frame.....
39421	—	Arch Clamp complete for 68-28 Machine, Nos. 23k, 108j, 658j, 39410, 39412 to 39415, 39417 to 39420, 39431, 39433, 39438 to 39451, two each 181j, 191k, 1186c, 1229c, 1547j, 1651j, 17803, three each 206f, 1302j, 1472j, five 613j, six 185j and eight 1053j, obsolete.....

Nos. 39422 to 39430 FOR 68-28 MACHINE

*39422	—	Arm with 4449, 15404, 17844 and two each 164e and 15405.....
*39423	—	Bed.....
39424	3788	Feed Across Plate with 17741 and 39427..
39425	3792	" " " Spring.....
39426	3788	" " " Adjusting Bracket.....
39427	3788	Feed Across Plate Spring Stud for 39424..
39428	3792	" " Regulator.....
39429	3793	" " " Link.....

NO.	PLATE	NAME
39430	3791	Feed Cam with 17874 and two each 190r and 1192c.....
39431	3793	Feed Plate for 39421 and 39482.....
*39432	3792	" " Carrier Bar for 39433.....
39433	—	" " " " 39432 with 934r, 1195e, 8505, 17743, 17802, 17804, 18368, two 7476 and four 17806, for 39421 and 39482.....
39434	3792	Presser Bar for 68-28 Machine, obsolete..
39438	3787	Tape Cutting Blade for 39421 and 39482.
39439	3787	" Feeding Foot with 1823, for 39421 and 39482.....
39440	7204	Tape Feeding Foot Holder for 39421, obsolete.....
39441	3787	Tape Feeding Foot Latch for 39421 and 39482.....
39442	3787	Tape Feeding Foot Latch Disengaging Wedge for 39421 and 63813.....
39443	3787	Tape Feeding Foot Latch Spring for 39421 and 39482.....
39444	7204	Tape Feeding Foot Roller Plate (back) for 39421, obsolete.....
39445	7204	Tape Feeding Foot Roller Plate (front) for 39421, obsolete.....
39446	3787	Tape Feeding Foot Spring for 39421 and 39482.....
Nos. 39447 to 39451 FOR 39421 AND 63813		
39447	3789	Tape Guide and Cutter.....
39448	3788	" " " " Spring.....
39449	3788	" " " " " Bracket for 39415.....
39450	3788	Tape Guide and Cutter Spring Bracket for 39447.....
39451	3788	Tape Guide Cap.....
39452	3796	Thread Wiper Body for 68-28 and 68-32 Machines.....
39453	3796	Thread Wiper Body Finger for 68-28 and 68-32 Machines.....
39454	3796	Thread Wiper Body Support for 68-28 Machine.....
39455	3796	Thread Wiper Body Wire for 68-28 and 68-32 Machines.....
39456	3796	Thread Wiper Body Wire Clamp for 68-28 and 68-32 Machines.....

NO.	PLATE	NAME
39457	3797	Throat Plate with 17749, 39213 and two each 1208d, 39458 and 50406d, for 39477.....
39458	3797	Throat Plate Oil Pad for 39457.....
39460	—	Knife Cam Lever Slide 39330 with 1255r and 39331, for 39409.....
Nos. 39461 to 39470 FOR 39471		
39461	7208	Arch Clamp (left) with 17723.....
39462	7208	" " (right) with 17723.....
39463	7208	" " Arm.....
39464	7209	" " Frame.....
39465	7208	" " Shank with 39307.....
39466	7208	" " " Plate.....
39467	7208	" " Spreader.....
39468	7209	" " Spring.....
39469	7208	" " " Adjusting Screw Sleeve
39470	7208	" " " Stop with two 17720.....
39471	—	Arch Clamp complete for 68-27 Machine, Nos. 747r, 1180r, 1182r, 1550r, 1654c, 7071, 17717, 17718, 18459, 39243, 39253, 39461 to 39470, 50237k, two each 181r, 211k, 402r, 1175r, 1183r, 1186c, 1651r, 14079, 17803 and five 217r.....
*39472	—	Bed for 68-27 Machine.....
39473	—	Feed Cam with two 1192c, three 17874 and six 190r, for 68-27 Machine.....
39474	—	Throat Plate 39294 with 1698e, 39270, 39291, 39488 and 50018r, for 68-9 and 68-20 Machines.....
39475	—	Throat Plate 39293 with 1698e, 39270, 39291, 39488 and 50018r, for 68-1, 68-4, 68-6, 68-7, 68-10 to 68-12, 68-14 to 68-19, 68-22 to 68-24, 68-27, 68-29 to 68-31, 68-34 and 68-36 to 68-38 Machines....
39477	—	Throat Plate 39457 with 1698e, 39270, 39291, 39488 and 50018r, for 68-28 Machine.....
39478	3786	Arch Clamp Foot Plate with 1607e and 2000, for 39482.....
39479	3787	Tape Feeding Foot Holder for 39482.....
39480	3787	" " " Roller Plate (back) for 63813.....
39481	3787	Tape Feeding Foot Roller Plate (front) for 63813.....

NO.	PLATE	NAME
39482	—	Arch Clamp complete for 68-28 Machine, Nos. 23κ, 108j, 658r, 1654c, 39410, 39412, 39414, 39418 to 39420, 39431, 39433, 39438, 39439, 39441, 39443, 39446, 39478, 39479, 63813, two each 181j, 191κ, 1053j, 1186c, 1229r, 1547j, 1651j, 17803 and six 185j.....
39483	7214	Bed Frame Cushion (leather) for 39233...
39484	3718	Table Bracket Machine Holder Cushion (leather) for 17875.....
39486	7214	Throat Plate Needle Hole Bushing for 63786.....
39487	3702	Shuttle Driver with two 457c, for all machines except 68-32.....
*39488	—	Knife Holder 39269 with 1198c, 17807, 17808 and 17829, for 39406, 39474, 39475, 39477, 63787, 63794 and 63843..
39489	7008	Protector Arm with 39490, for 63753.....
39490	—	" Blade for 39489.....
Nos. 39491 to 39494 FOR 63753		
39491	7008	Protector Bracket with two each 426c and 448c.....
39492	7009	Protector Crank with 160c.....
39493	7009	" " Bracket with 1120c and two 454c.....
39494	7008	Protector Rod.....
39495	7009	" " Connection for 39498.....
39496	7008	" " Sleeve for 63753.....
39497	7009	" " Spring for 63753.....
39498	—	Protector (front of needle) complete, Nos. 39495, 63753 and two each 176j and 50351j.....
41400	7211	Machine Rest Pin (wood) 3¼ in. long (Attachments and Accessories).....
41598	3780	Bobbin Winder Base with 27916 and two 28084, for 41604 and 41713.....
41600	3780	Bobbin Winder Pulley with 155c, for 41604 and 41713.....
41604	—	Bobbin Winder for 41716, Nos. 35D, 1620j, 27321, 27328, 27538, 41598, 41600, 41825 and 50356D.....
41713	3780	Bobbin Winder for 41714, Nos. 35D, 1620r, 27305, 27321, 27326, 41598, 41600, 41825 and 50356D.....

NO.	PLATE	NAME
41714	—	Bobbin Winder (swinging automatic, left hand) complete for 2073, Nos. 161j, 41713, 60770 and two 1186c.....
41716	—	Bobbin Winder (swinging automatic, left hand) complete for 2996, Nos. 161j, 41604, 60770 and two 1186c.....
41825	3781	Bobbin Winder Frame Spring for 41604 and 41713.....
41828	—	Bobbin Winder Spindle Collar Pin for 27538.....
42007	7213	Smocking Clamping Blade Holder Hinge Pin for 63717.....
43808	7214	Bobbin Winder Tension Spring for 60770.
*44001	—	Shuttle Cover 2075 with 112E, 466H, 2078, 2080, 2086 and 2090, for 39296.....
46244	7235	Feed Across Regulator Adjusting Screw Stud Nut Washer (fibre).....
50018r	3753	Knife Holder Pinion Stud Bracket Screw for 39406, 39474, 39475, 39477, 63787, 63794, 63843 and 63845.....
50029c	3759	Knife Cam Lever Hinge Screw for 18472..
50048j	3761	Clamp Arm Bracket Hinge Screw (eccentric) for 39336.....
50130j	7218	Bar Locating Finger Holder Screw for 68-34 Machine, obsolete.....
50150c	7215	Arch Clamp Ring Leveling Stud Spring Screw for 63852.....
50222j	20884	Thread Lubricator Bracket Screw for 65092.....
50237κ	3705	Arch Clamp Spreader Lever Hinge Screw for 39471.....
50237κ	3705	Buckle Clamp Spreader Lever Hinge Screw for 63971.....
50237κ	3705	Button Clamp Spreader Lever Hinge Screw for 17898, 17904, 63928 and 63929.....
50237κ	3705	Clamp Spreader Lever Hinge Screw for 39319 and 63939.....
50301c	7215	Arch Clamp Ring Leveling Stud Holder Screw Bushing Set Screw for 63851.....
50333c	3788	Arm Shaft Bushing (back) Adjusting Screw.....
50351j	7009	Protector Bracket Screw for 39498.....
50356D	7215	Bobbin Winder Frame Hinge Screw for 41604 and 41713.....
50406D	7213	Throat Plate Extension Screw for 17870, 17925, 39214, 39273 to 39275, 39292 to 39294, 39402, 39457, 63786 and 63791..

NO.	PLATE	NAME
50436J	7215	Arch Clamp Ratchet Lever Pawl Hinge Screw for 63854.....
50458J	7215	Arch Clamp Ring Holder Shank Lifting Screw Stud for 63849.....
50599D	7235	Feed Across Regulator Adjusting Screw Stud.....
50682c	7235	Stop Cam Interlocking Rod Case Spring Adjusting Screw for 39344.....
51041c	20333	Arch Clamp Foot Spring Screw for 63985
51387B	20339	Pulley (loose) Cap Screw for 68717.....
51853	7239	Arch Clamp Closing Bell Crank Roller and Stud for 63948.....
51854	7240	Arch Clamp Foot Roller and Screw Stud (eccentric) with 1611E, for 63954 and 63955.....
52544	7215	Arch Clamp Ring Leveling Stud Spring for 63852.....
52598	7009	Protector Crank Hinge Stud for 63753....
55283	—	Thread Take-up Lever 18393 with 79c, for 68-21 and 68-32 Machine.....
*55302	—	Thread Take-up Cam for 18392.....
55381	7235	Feed Across Connection (lever end) Ball Stud for 63941.....
56791	—	Tension complete for 17725, Nos. 2103, 2124, 16202 and two 2102.....
56855	—	Thread Take-up Lever 3072 with 1088c, for all machines except 68-21 and 68-32
56864	7236	Starting Lever and Foot Lifter Chain Hook (large) for 6439.....
56864	7236	Starting Lever Rock Shaft Chain Hook for 14224.....
56865	7235	Starting Lever and Foot Lifter Chain Hook (small) for 6439.....
59787	7214	Thread Wiper Body Support for 68-32 Machine.....
60769	3780	Bobbin Winder Tension Bracket for 60770
60770	3780	Bobbin Winder Tension Bracket complete for 41714 and 41716, Nos. 419E, 1562J, 8422, 9780, 43808, 60769 and two 2455.....
62155	20334	Feed Cam Shaft for all machines except 68-34.....
*62818	—	Thread Lubricator Bracket for 65091.....
62819	20884	" " Oil Pad (felt) for 65089
*62820	—	" " " " Holder for 65088.....
62824	20884	Thread Lubricator Oil Pad Retainer for 65089.....

NO.	PLATE	NAME
62827	20334	Thread Lubricator Oil Wick (braided cotton) for 65089.....
62830	—	Thread Lubricator Oil Reservoir for 65091
63535	—	Shuttle, 1 $\frac{1}{16}$ in. diam., for 68-32 Machine, Nos. 2515, 2996 and 33942.....
63701	7210	Feed Plate for 63717.....
*63702	7212	" " Carrier Bar for 63703.....
Nos. 63703 to 63716 for 63717		
63703	—	Feed Plate Carrier Bar 63702 with 934J, 1195E, 8505, 17743, 17802, 17804, 18368, two 7476 and three 17806.....
63704	7212	Smocking Clamping Blade.....
63705	7213	" " " " Holder.....
63706	7212	" " " " Bracket with 1120K and two 1259c.....
63707	7212	Smocking Clamping Blade Holder Spring...
63708	7213	" " " " Lifting Hook...
63709	7212	" Guide (left) $\frac{1}{4}$ in.....
63710	—	" " " " $\frac{3}{16}$ in.....
63711	7212	" " (right) $\frac{1}{4}$ in.....
63712	—	" " " " $\frac{3}{16}$ in.....
63713	7212	" " Holder with two 1057E...
63714	7212	" " " " Arm.....
63715	7213	" Indicator (left).....
63716	7213	" " (right).....
63717	—	Smocking Attachment complete for 68-31 Machine, Nos. 287J, 1654c, 27659, 42007, 63701, 63703 to 63716 and two each 107J, 172J, 190J, 1186c, 17803, 22232 and three 1651J.....
63718	—	Throat Plate Needle Hole Bushing for 68-21 Machine.....
63724	7206	Arch Clamp Foot (left) with 63726, for 63728.....
63725	7206	Arch Clamp Foot (right) with 63726, for 63728.....
63726	7206	Arch Clamp Foot Lifting Stud for 63724, 63725, 63731 and 63732.....
63727	7207	Arch Clamp Frame for 63728.....
63728	—	Arch Clamp complete for 68-20 Machine, Nos. 1654c, 18433, 18434, 39253, 39302, 39311, 63724, 63725, 63727, two each 181J, 1175J, 1186c, 1651J, 14079, 17803 and five 217J.....
63729	—	Arch Clamp Foot (left) 39353 with 219K and 63731, for 63735.....

NO.	PLATE	NAME
63730	—	Arch Clamp Foot (right) 39355 with 219x and 63732, for 63735.....
63731	7206	Arch Clamp Foot Shank (left) with 63726, for 63729.....
63732	7206	Arch Clamp Foot Shank (right) with 63726, for 63730.....
63733	7207	Arch Clamp Foot Spring (light) for 63735
63734	7207	" " Frame for 63735 and 63854..
63735	—	Arch Clamp complete for 68-24 Machine, Nos. 1654c, 18477, 39358, 39360, 63729, 63730, 63734, two each 181j, 1186c, 1229f, 1547j, 1651j, 14079, 17803, 63733 and four 190j.....
*63736	—	Face Plate 17724 with 2105, for 17725....
Nos. 63737 to 63741 FOR 63746, OBSOLETE		
63737	—	Button Clamp (left) with 1053j, 17723, 63743, 63979 and three 9311.....
63738	—	Button Clamp (right) with 1053j, 17723, 63744, 63980 and three 9311.....
63739	—	Button Clamp Arm with 17714 and 63788
63740	—	" " Spreader Lever.....
63741	—	" " " Thumb Plate....
63742	—	" " " " " Pin for 63745, obsolete.....
63743	—	Button Clamp Spring (left) for 63737, obsolete.....
63744	—	Button Clamp Spring (right) for 63738, obsolete.....
63745	—	Button Clamp Stop with 17720 and 63742, for 63746, obsolete.....
63746	—	Button Clamp (universal) complete, for 14 to 45 line buttons, adjustable for buttons $\frac{3}{4}$ in. to $\frac{1}{2}$ in. thick, for 68-6 and 68-7 Machines, Nos. 104d, 1180j, 1181j, 1182j, 1182e, 1183j, 17718, 17719, 39242, 63737 to 63741, 63745 and two 1175j, obsolete.....
*63749	—	Thread Take-off Cam for 39204.....
63751	—	Button Clamp Extension for 63737 and 63738, obsolete.....
63752	—	Stop Cam Interlocking Rod Case Bracket complete for 39349, Nos. 1182e, 1196c, 1204e, 1254c, 1262c, 1508e, 1662c, 17853, 17859, 17861, 17862, 17872, 17873, 39348, 39405 and two 898d.....

NO.	PLATE	NAME
63753	—	Protector (front of needle) for 39498, Nos. 1099f, 39489, 39491 to 39494, 39496, 39497, 52598 and two 15261.....
63754	—	Stop Cam Interlocking Rod Case Bracket complete for 39347, Nos. 1182e, 1196c, 1204e, 1254c, 1262c, 1508e, 1662c, 17853, 17859, 17861, 17862, 17872, 17873, 39346, 39405 and two 898d.....
63756	—	Needle Bar Connecting Link 39203 with 21629.....
63757	7206	Arch Clamp Foot Lifter with 1340c, for 68-28 Machine.....
63758	7212	Presser Bar for 68-28 Machine.....
*63759	—	Stop Cam Interlocking Rod Case 39280 with 1318d, 17855, 17863, 17864, 39222, 39223 and two 1255j, for 39281 and 39289, obsolete.....
63761	7216	Arch Clamp Indicator Plate for 63854....
Nos. 63763 to 63766 FOR 63854		
63763	7216	Arch Clamp Ratchet Lever.....
63764	7215	" " " Pawl.....
63765	7215	" " " " " Spring....
63766	7216	" " " Ring.....
63767	7215	" " " " " Position Pin for 63846.....
63770	—	Arch Clamp Ring Holder Shank (left) with 39307, obsolete.....
63771	—	Arch Clamp Ring Holder Shank (right) with 39307, obsolete.....
63772	7215	Arch Clamp Ring Stop for 63854.....
63774	7216	Feed Plate for 63854.....
63776	7211	Needle Bar (hollow) for 63785.....
63781	—	Clamp Arm (lower) Bracket 17978 with 14008 and 17981, for 17987.....
Nos. 63782 to 63784 FOR 63785		
63782	7215	Needle Clamp with 237f.....
63783	7215	" Stripper.....
63784	7215	" " Spring.....
63785	—	Needle Bar complete for 68-33 Machine, Nos. 706d, 63776 and 63782 to 63784....
63786	—	Throat Plate 63997 with 17749, 39486 and two each 1208d and 50406d, for 63787 and 63845.....

NO.	PLATE	NAME
63787	—	Throat Plate 63786 with 1698E, 39270, 39291, 39488 and 50018F, for 68-21 Machine.....
63788	7205	Buckle Clamp Arm Hook for 17927 and 63970.....
63788	7205	Button Clamp Arm Hook for 17927, 63739 and 63927.....
63788	7205	Clamp Arm Hook for 17908, 17927, 17947 and 63935.....
63789	7215	Arch Clamp Ring Spur for 63846.....
63790	7217	Throat Plate Needle Hole Bushing for 63791.....
63791	7217	Throat Plate 63997 with 17749, 63790 and two each 1208D and 50406D, for 63794..
Nos. 63792 TO 63794 FOR 68-33 MACHINE		
63792	7211	Needle Bar Thread Nipper Lever with 17835.....
63793	7215	Needle Bar Thread Nipper Lever Spring..
63794	—	Throat Plate 63791 with 1698E, 39270, 39291, 39488 and 50018F.....
63796	7216	Feed Plate Ring for 63854.....
*63804	—	Arm with 4449, 15404, 17844 and two each 164E and 15405, for 68-33 Machine, obsolete.....
*63805	—	Bed for 68-20, 68-24 and 68-33 Machines..
*63806	—	Knife Bar for 63807.....
63807	—	" " 63806 with 63808, 63809 and two 17814, for 39299.....
63808	7206	Knife Bar Connection for 17914 and 63807
63809	—	" " " Slide Block 17915 with 63810, for 63807.....
63810	7206	Knife Bar Connection Slide Block Stud for 63809.....
63811	7205	Clamp Arm (lower) with two 17992, for 39337.....
63812	7205	Clamp Arm (upper) for 39337.....
63813	—	Arch Clamp Foot 39415 with 39413, 39442, 39447 to 39451, 39480, 39481, three each 206F, 1302J, 1472J, five 613J and six 1053J, for 39482.....
63814	—	Shuttle Race Body for 63815.....
63815	3719	Shuttle Race complete, for all machines except 68-32, Nos. 17746, 63814 and two 190c.....
63816	7215	Arch Clamp Indicator Finger for 63854..

NO.	PLATE	NAME
Nos. 63817 TO 63819 FOR 63820, OBSOLETE		
63817	7218	Arch Clamp Foot with 17959.....
63818	7218	" " " Plate.....
63819	7209	" " Frame.....
63820	—	Arch Clamp complete for 68-34 Machine, Nos. 405J, 1190c, 63817 to 63819, 63825, 63831, 63833, 63836, two each 181J, 1186c, 1651J, 14079, 17803 and five 217J, obsolete.....
Nos. 63821 TO 63824 FOR 68-34 MACHINE, OBSOLETE		
63821	7216	Bar Locating Finger.....
63822	7216	" " " Holder.....
63823	7216	" " " Extension
63824	7218	" " " " " " Spring.....
63825	7218	Arch Clamp Closing Bell Crank Spring Stud for 63948 and 63963.....
63825	7218	Bar Locating Finger Holder Extension Spring Stud for 63820, obsolete.....
63826	7216	Bar Locating Finger Tripping Lever with 63828, for 68-34 Machine, obsolete.....
63827	7218	Bar Locating Finger Tripping Lever Hinge Screw Stud for 68-34 Machine, obsolete
63828	7216	Bar Locating Finger Tripping Lever Sleeve for 63826, obsolete.....
63829	7218	Bar Locating Finger Tripping Lever Stud for 63830, obsolete.....
63830	—	Feed Cam with two each 1192c, 17874, 63829 and four 190J, for 68-34 Machine, obsolete.....
63831	7210	Feed Plate for 63820, obsolete.....
*63832	7212	" " Carrier Bar for 63833, obsolete
63833	—	" " " " 63832 with 934J, 17743, 17802, 17804, 18390, two 7476 and four 17806, for 63820, obsolete.....
63834	7211	Feed Across Regulator for 68-27 Machine
63836	7218	Arch Clamp Foot Spring for 63820, obsolete.....
63837	7213	Arch Clamp Foot Lifter for 68-32 Machine
63838	7213	" " " Plate for 63839.....
63839	—	Arch Clamp complete for 68-32 Machine, Nos. 1654c, 17964, 17965, 17967, 17968, 17970, 39254, 39302, 63838, two each 1175J, 1177J, 1186c, 1651J, 14079, 17803 and five 217J.....

From the library of: Diamond Needle Corp

NO.	PLATE	NAME
63840	—	Shuttle Race Body for 63946.....
63841	7214	“ “ Cap for 63946.....
63842	7211	Shuttle Race complete for 68-32 Machine, Nos. 907D, 2531, 2533, 24412, 63946 and two each 391J and 2532.....
63843	—	Throat Plate 39402 with 1698E, 39270, 39291, 39488 and 50018F, for 68-25 and 68-26 Machines.....
63844	—	Knife Holder 39269 with 1198c, 17808, 17829 and 68708, for 63845.....
63845	—	Throat Plate 63786 with 1698E, 39270, 39291, 50018F and 63844, for 68-32 Machine.....
Nos. 63846 to 63849 FOR 63854		
63846	7216	Arch Clamp Ring with 63767 and ten 63789
63847	7215	“ “ “ Compensating Stud.....
63848	7216	“ “ “ Holder.....
63849	7216	“ “ “ “ Shank with 50458J
63850	7215	“ “ “ “ Leveling Stud for 63852
63851	7215	“ “ “ “ “ Holder with two 50301c, for 63852.....
63852	—	Arch Clamp Ring Leveling Stud Holder complete for 63854, Nos. 63851 and two each 50150c, 52544, 63850 and 63853...
63853	7215	Arch Clamp Ring Leveling Stud Holder Screw Bushing for 63852.....
63854	—	Arch Clamp complete for 68-33 Machine, Nos. 217J, 226J, 1654c, 18477, 39360, 50436J, 63734, 63761, 63763 to 63766, 63772, 63774, 63796, 63816, 63846, 63848, 63849, 63852, two each 108J, 181J, 1186c, 1229c, 1547J, 1651J, 14079, 17803, 18480, four 190J, five 229J and ten each 8282 and 63847.....
63927	7205	Button Clamp Arm with 17714 and 63788, for 63928 and 63929.....
63928	—	Button Clamp (universal) complete, for 10 to 50 line thin buttons, for 68-1, 68-4, 68-6, 68-7, 68-29 and 68-30 Machines, Nos. 1180J, 1181J, 1182J, 1183J, 17717 to 17719, 39238, 39239, 39242, 39244 or 39246, 39245 or 39247, 39248, 50237K, 63927 and two each 229J and 1175J....

NO.	PLATE	NAME
63929	—	Button Clamp (universal) complete, for 26 to 55 line buttons, for 68-21 Machine, 1180J, 1181J, 1182J, 1183J, 17717 to 17719, 18464 to 18466, 39242, 39244 or 39246, 39245 or 39247, 50237K, 63927 and two each 229J and 1175J.....
63930	7238	Feed Plate (thin) for 68-22 Machine.....
63931	7238	“ “ for 68-36 Machine.....
63932	7238	“ “ “ 68-37 Machine.....
Nos. 63933 to 63938 FOR 63939		
63933	7237	Clamp (left) with 9311 and 17723.....
63934	7237	“ (right) with 9311 and 17723.....
63935	7237	“ Arm with 17714 and 63788.....
63936	7237	“ Spring (left).....
63937	7237	“ “ (right).....
63938	7239	“ Stop.....
63939	—	Clamp complete for 68-36 and 68-37 Ma- chines, Nos. 1181J, 1182J, 1183J, 17716, 17717, 17719, 39318, 50237K, 63933 to 63938 and two each 240J, 1175J, 1180J and 17718.....
63940	7235	Feed Across Connection (lever end) with two 896E, for 63941.....
63941	—	Feed Across Connection (lever end) 63940 with 55381.....
63942	7235	Feed Across Connection (regulator end) with two 896E, for 63943.....
63943	—	Feed Across Connection (regulator end) 63942 with 63944.....
63944	7235	Feed Across Connection (regulator end) Ball Stud for 63943.....
63945	—	Stop Cam Interlocking Rod Case for 39345, obsolete.....
63946	—	Shuttle Race Body 63840 with 1053J, 2523 and 63841, for 63842.....
Nos. 63947 to 63949 FOR 63988		
63947	7239	Arch Clamp Bar Locating Finger with 63969.....
63948	7236	Arch Clamp Closing Bell Crank with 51853 and 63825.....
63949	7239	Arch Clamp Closing Bell Crank Bracket..
Nos. 63950 to 63952 FOR 68-38 MACHINE		
63950	7236	Arch Clamp Closing Bell Crank Connect- ing Rod.....

NO.	PLATE	NAME
63951	7239	Arch Clamp Closing Bell Crank Connecting Rod Collar with 237f.....
63952	7239	Arch Clamp Closing Bell Crank Spring....
63953	7240	" " " Slide for 63988.....
63954	7240	" " " Foot (left) with 51854, for 63985.....
63955	7240	Arch Clamp Foot (right) with 51854, for 63985.....
63957	7240	Arch Clamp Foot Plate Cap (lower) for 63988.....
63958	7240	Arch Clamp Foot Plate Cap (upper) for 63988.....
63960	7236	Arch Clamp Frame for 63988.....
63963	7236	Feed Across Lever Bracket with 17732, 63825 and three 160j, for 68-38 Machine.....
63965	7239	Feed Plate for 63988.....
63966	7236	Starting Lever for 63967.....
63967	—	Stop Cam Interlocking Rod Case Bracket complete for 63968, Nos. 1182e, 1196c, 1204e, 1254c, 1262c, 1508e, 1662c, 17859, 17861, 17862, 17872, 17873, 39346, 39405, 63966 and two 898d.....
63968	—	Stop Cam Interlocking Rod Case Bracket 63967 with 39343, 39344 and two 1186j, for 68-38 Machine.....
*63969	7239	Arch Clamp Bar Locating Finger Pointer for 63947.....
63970	7237	Buckle Clamp Arm with 17714 and 63788, for 63971.....
63971	—	Buckle Clamp (adjustable) complete, for buckles without tongue, for 68-22 Machine, Nos. 1181j, 1182j, 1183j, 17717, 17719, 39242, 39363, 39364, 39366 to 39369, 50237k, 63970 and two each 229j, 1175j, 1180j and 17718.....
63973	—	Table Belt Guide Pulley Shaft (long) Wick (braided cotton) for 39219.....
63974	—	Table Belt Guide Pulley Shaft (short) Wick (braided cotton) for 39220.....
63975	7236	Pulley (loose) 2 3/4 in. diam., for 17955....
63976	7235	Belt Shifter Clamp for 63993.....
63977	7236	Stop Cam Interlocking Rod Case for 63978
63978	—	" " " " " 63977 with 18443 and two 193j, for 63993.....
63979	7239	Button Clamp (left) Extension for 63737, obsolete.....

NO.	PLATE	NAME
63980	7239	Button Clamp (right) Extension for 63738, obsolete.....
63981	—	Starting Lever Rock Shaft complete, Nos. 7124, 14224, 32134 and two each 2770, 16128 and 27683.....
63983	20333	Arch Clamp Foot Adjusting Screw Bracket for 63985.....
63984	20333	Arch Clamp Foot Plate with 17959, for 63985.....
63985	—	Arch Clamp Foot Plate 63984 with 51041c, 63954, 63955, 63983, 63986 and two each 190j, 910c and 1601j, for 63988.....
63986	20333	Arch Clamp Foot Spring for 63985.....
63987	20334	" " Pressure Spring for 63988....
63988	—	Arch Clamp complete for 68-38 Machine, Nos. 28c, 141c, 405e, 788d, 1654c, 39253, 63947 to 63949, 63953, 63957, 63958, 63960, 63965, 63985, 63987, two each 181j, 183j, 1186c, 1651j, 14079, 17803 and four 217j.....
*63989	—	Arm with 4449, 15404, 17844 and two each 164e and 15405, for 68-1, 68-4, 68-6, 68-7, 68-9, 68-11, 68-12, 68-14 to 68-27, 68-29 to 68-31 and 68-36 to 68-38 Machines..
*63990	—	Arm with 4449, 15404, 17844 and two each 164e and 15405, for 68-10 and 68-32 Machines.....
*63991	—	Arm with 4449, 15404, 17844 and two each 164e and 15405, for 68-28 Machine....
*63992	—	Arm with 4449, 15404, 17844 and two each 164e and 15405, for 68-33 Machine....
63993	—	Stop Cam Interlocking Rod Case 63978 with 63976 and two 1255j, for 39405...
63997	—	Throat Plate Body for 39292 to 39294 and 63791.....
65087	20884	Thread Lubricator Bracket Extension for 65092.....
65088	—	Thread Lubricator Oil Pad Holder 62820 with 65090, for 65089.....
65089	20884	Thread Lubricator Oil Pad Holder 65088 with 62819, 62824 and 62827, for 65091
*65090	—	Thread Lubricator Oil Pad Holder Oil Tube for 65088.....
65091	20884	Thread Lubricator complete for 65092, Nos. 8068, 17822, 62818, 62830, 65089 and 124371.....

NO.	PLATE	NAME
65092	20884	Thread Lubricator 65091 with 1529E, 50222, 65087 and two 21202.....
68708	20333	Knife (needle thread) for 63844.....
68710	—	" Holder for 39269.....
68712	20340	Pulley (loose) 2¼ in. diam., with 200584d, for 68713.....
68713	—	Pulley (loose) 68712 with 68714 for 68717..
68714	20340	" " Ball Bearing for 68713.....
68715	20339	" " Bushing for 68717.....
68716	20340	" (tight) 2¼ in. diam., for 68720.....
68717	—	Pulleys (ball bearing) complete, Nos. 51387a, 68713, 68715 and 68720.....
68720	—	Pulley (tight) 68716 with 1206c and 17854, for 68717.....
120341	4079	Tweezers, curved (Attachments and Accessories).....
120346	4079	Oiler (copper plated) with 120347 (Attachments and Accessories).....
120347	4079	Oiler Spout, 8¼ in. long, for 120346.....
124371	20884	Thread Lubricator Oil Reservoir Rivet Washer (outside) for 65091.....
124674	20334	Arm Side Cover.....
150203	20335	Thread Unwinder Spool Rest Cushion (felt) for 225258.....
200383c	7235	Thread Unwinder Spool Rest Rod Set Screw for 202490.....
201018c	7235	Thread Unwinder Spool Rest Set Screw for 225257.....
201696j	7235	Thread Unwinder Thread Guide Lock Nut for 225258.....
202490	20335	Thread Unwinder Spool Stand with 200383c, for 225258.....
225257	20335	Thread Unwinder Spool Rest with 201018c, for 225258.....
225258	20335	Thread Unwinder complete, for two spools or two large cones of thread, Nos. 201696j, 202490, 225257, 225324, 225326, 225388, two each 150203, 225391 and three wood screws ¼ in. No. 12.....
225322	20333	Thread Unwinder Thread Guide Rod Washer for 225324.....
225324	20335	Thread Unwinder Thread Guide Rod with 208E and 225322, for 225258.....
225326	20335	Thread Unwinder Thread Guide Position Cup for 225258.....
225388	20335	Thread Unwinder Spool Rest Rod for 225258.....
225390	7234	Thread Unwinder Thread Cone Holder, for inverted cones, for 225258.....
225391	20335	Thread Unwinder Thread Guide for 225258

PLATE 3700—FULL SIZE

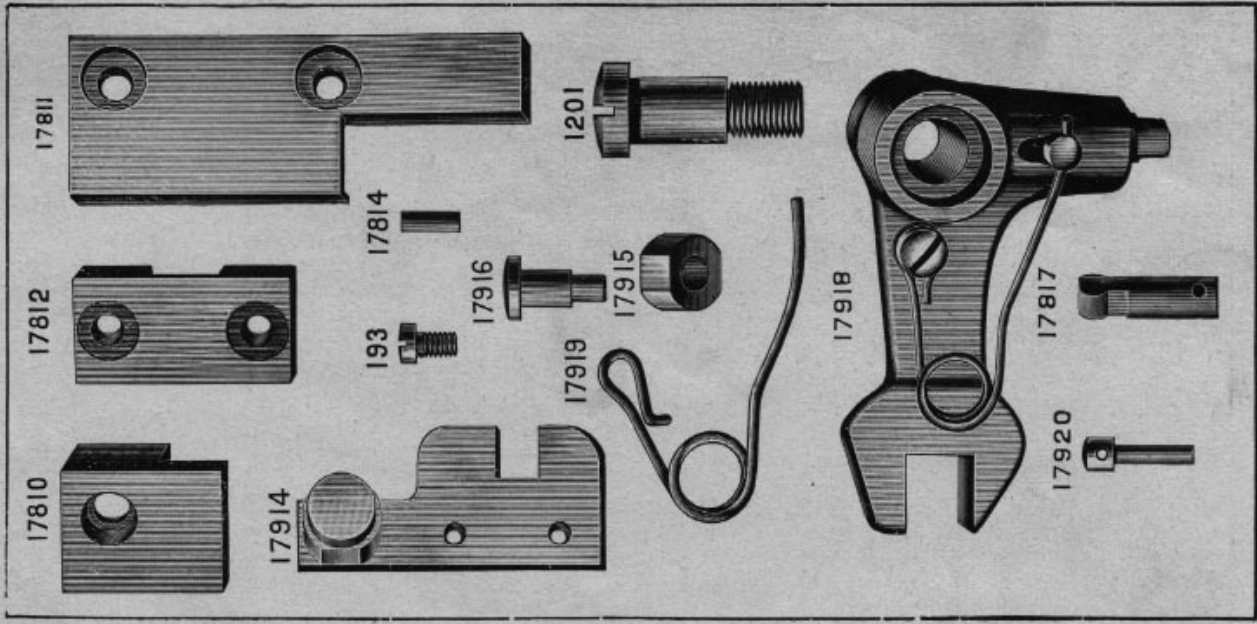

PLATE 3701—FULL SIZE

17735

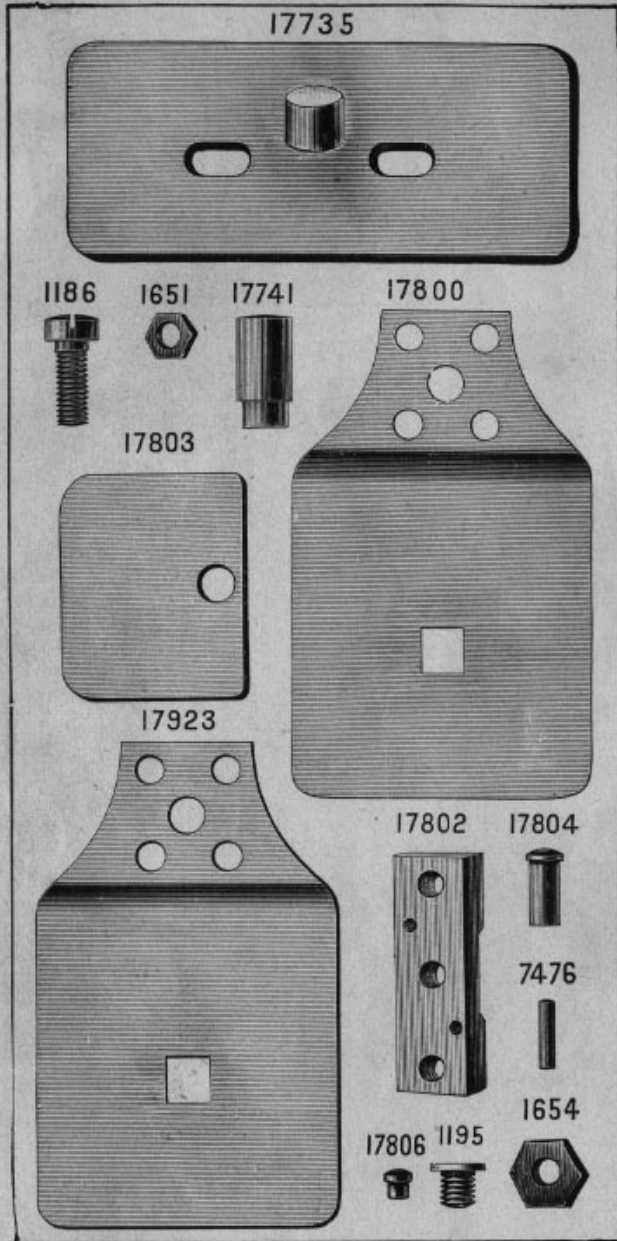
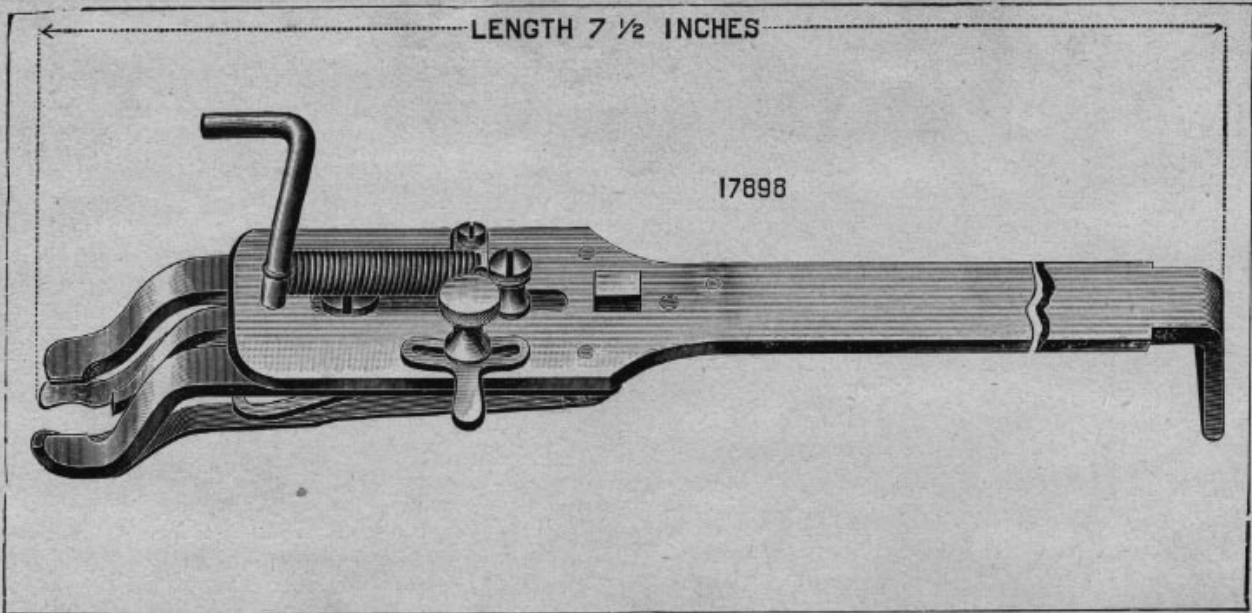

PLATE 3702—FULL SIZE



From the library of: Diamond Needle Corp



LENGTH 7 1/2 INCHES

17898

PLATE 3703—FULL SIZE

PLATE 3704—FULL SIZE

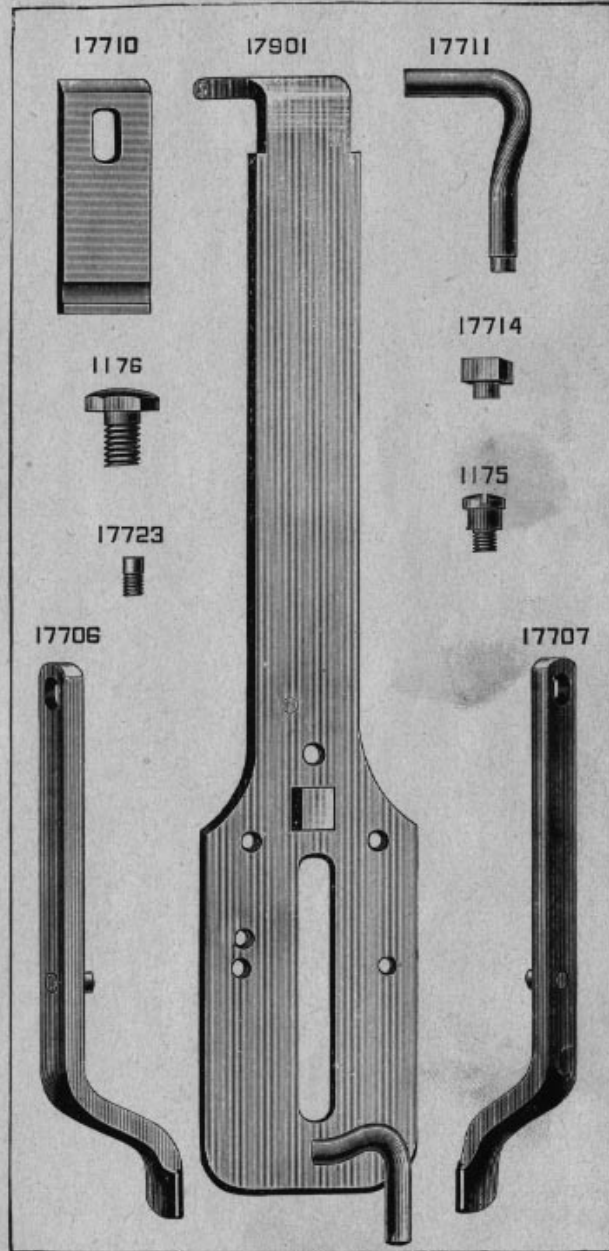

PLATE 3705—FULL SIZE

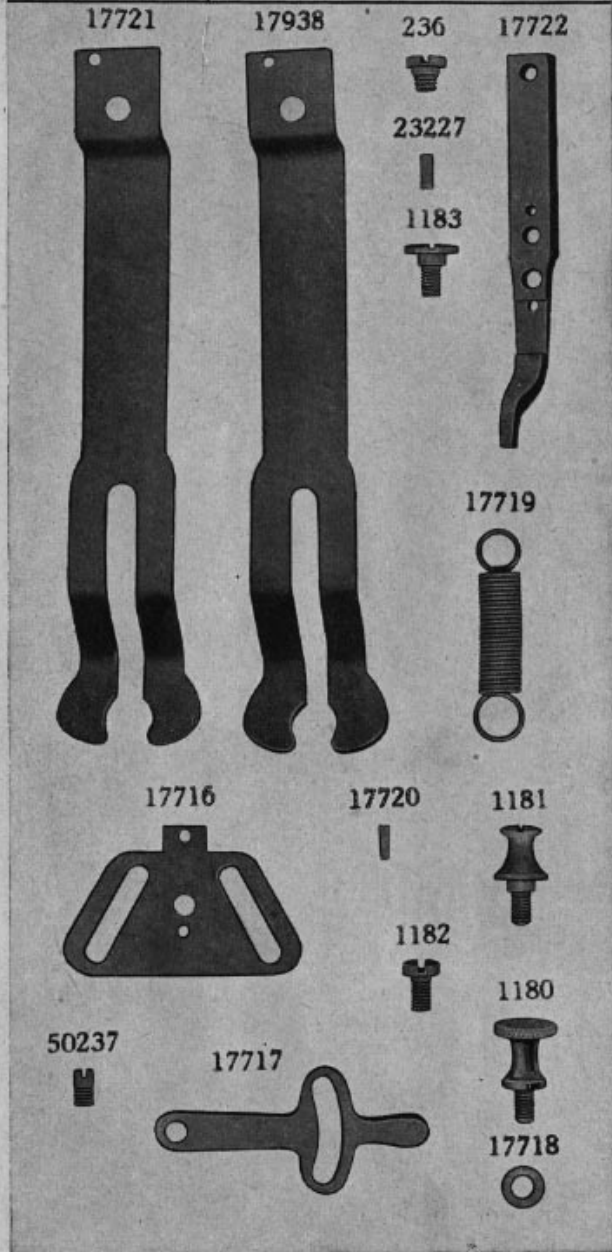
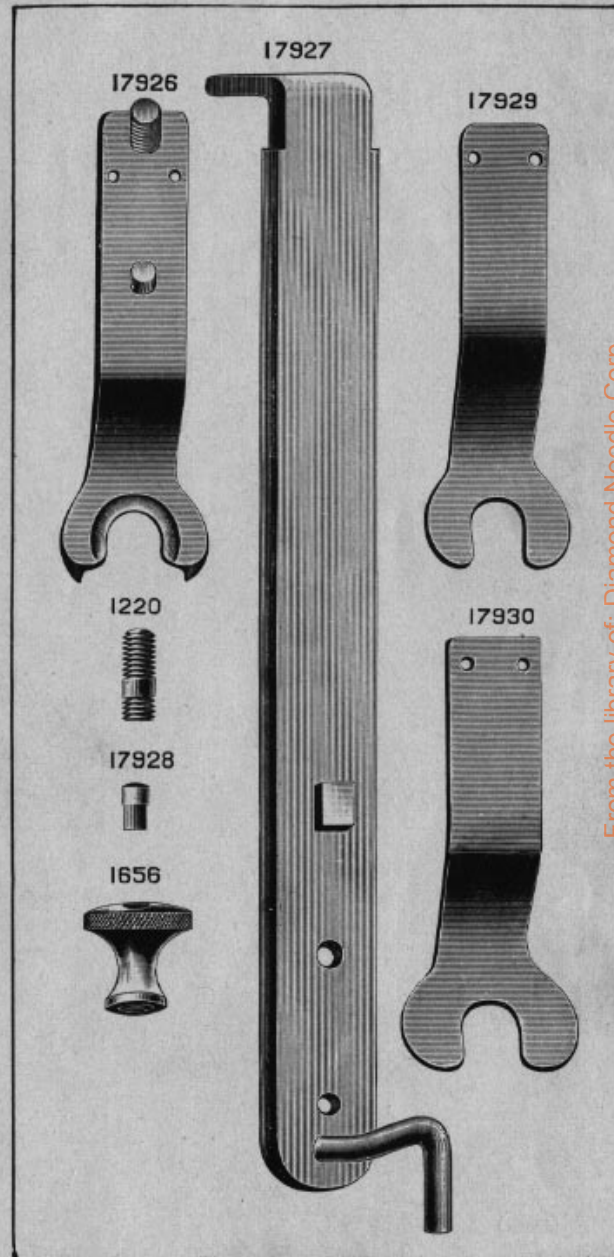

PLATE 3706—FULL SIZE



From the library of: Diamond Needle Corp

PLATE 3707—FULL SIZE

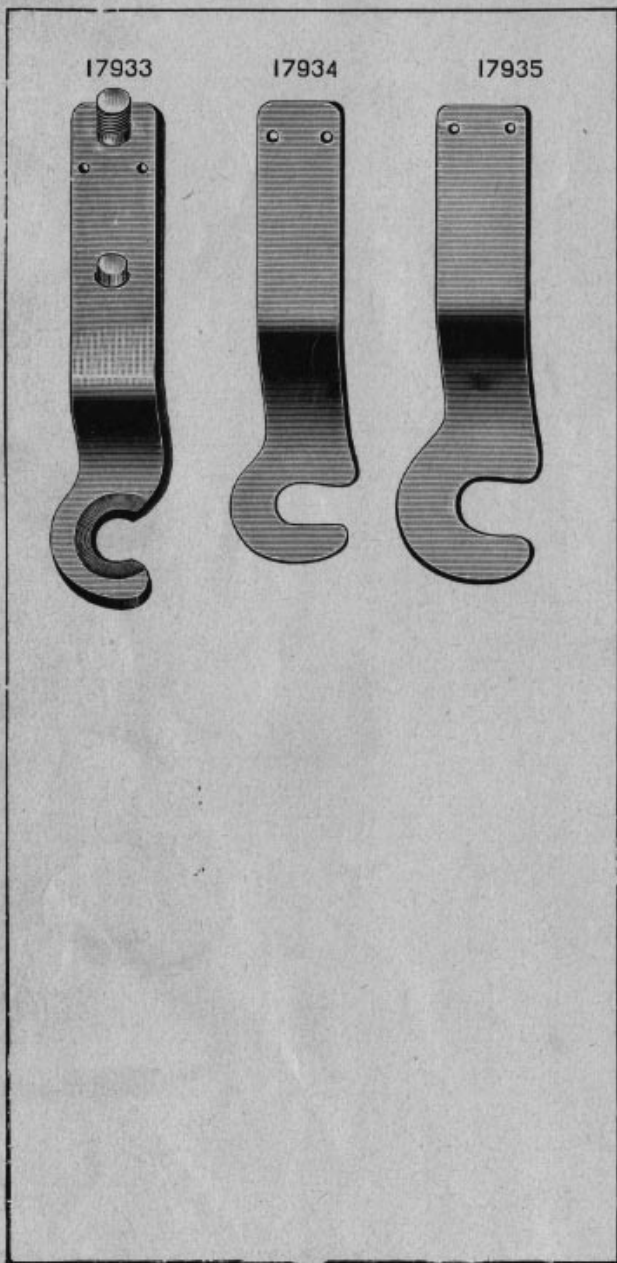

PLATE 3708—FULL SIZE

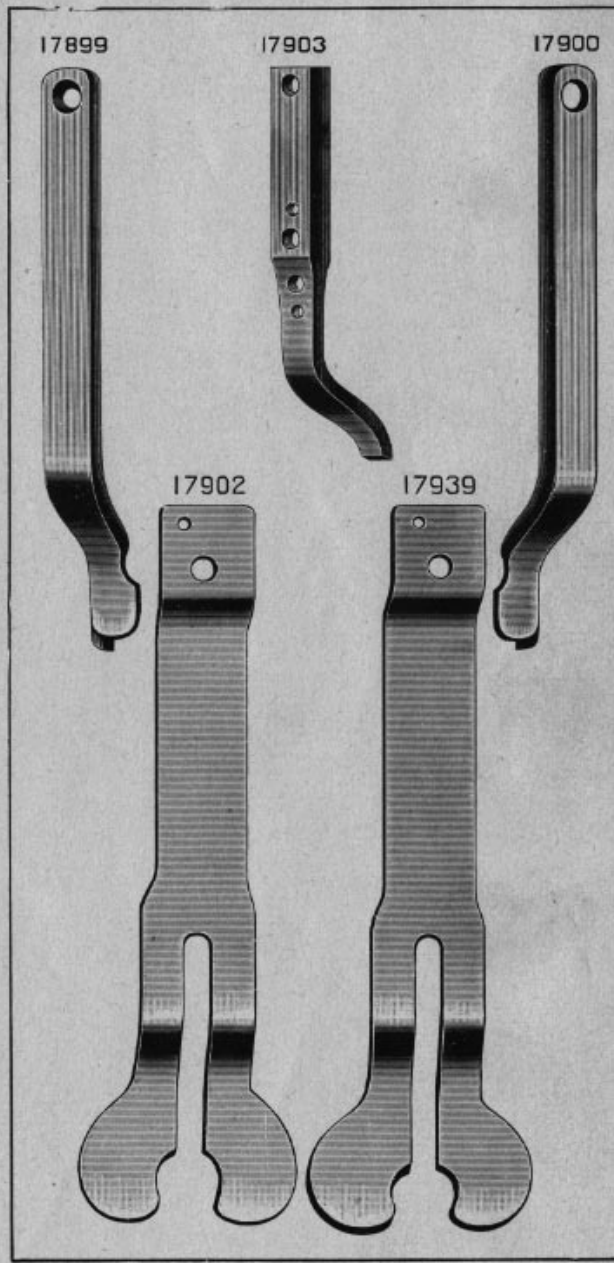

PLATE 3709—FULL SIZE

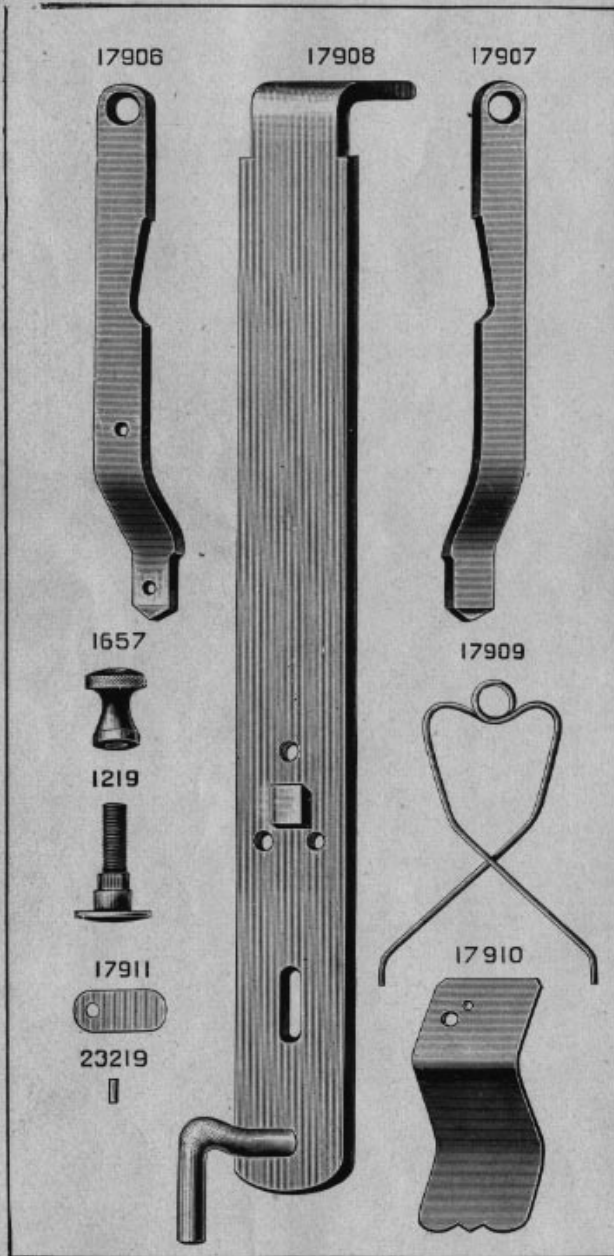
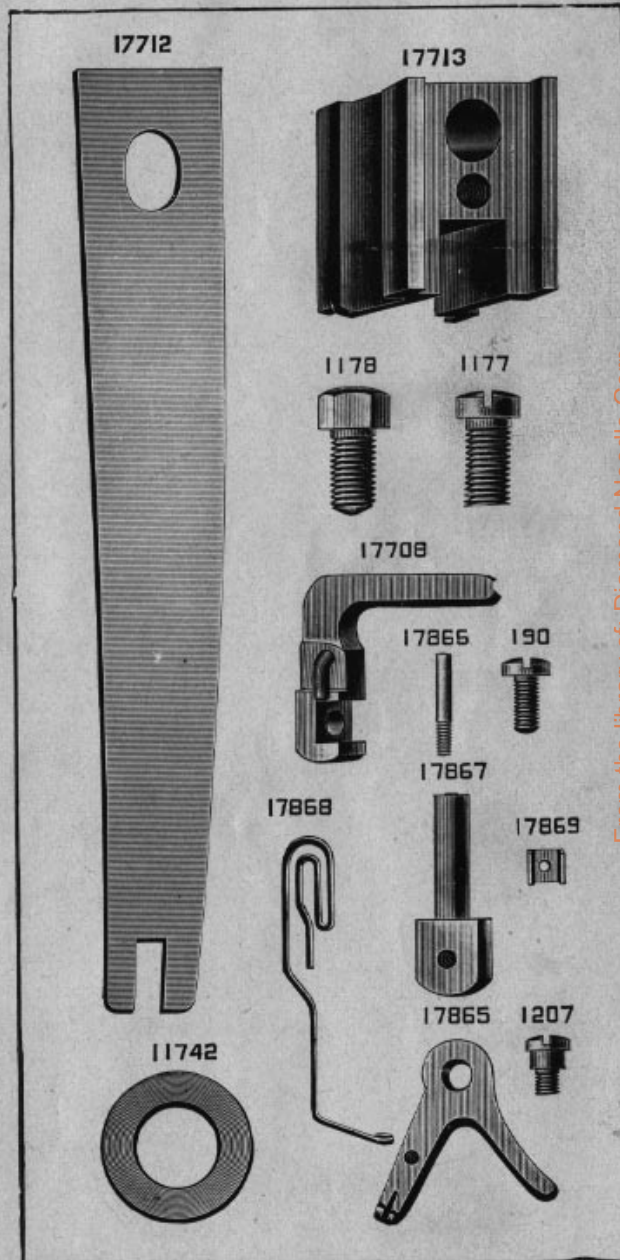

PLATE 3710—FULL SIZE



From the library of: Diamond Needle Corp

PLATE 3711—ONE-HALF SIZE

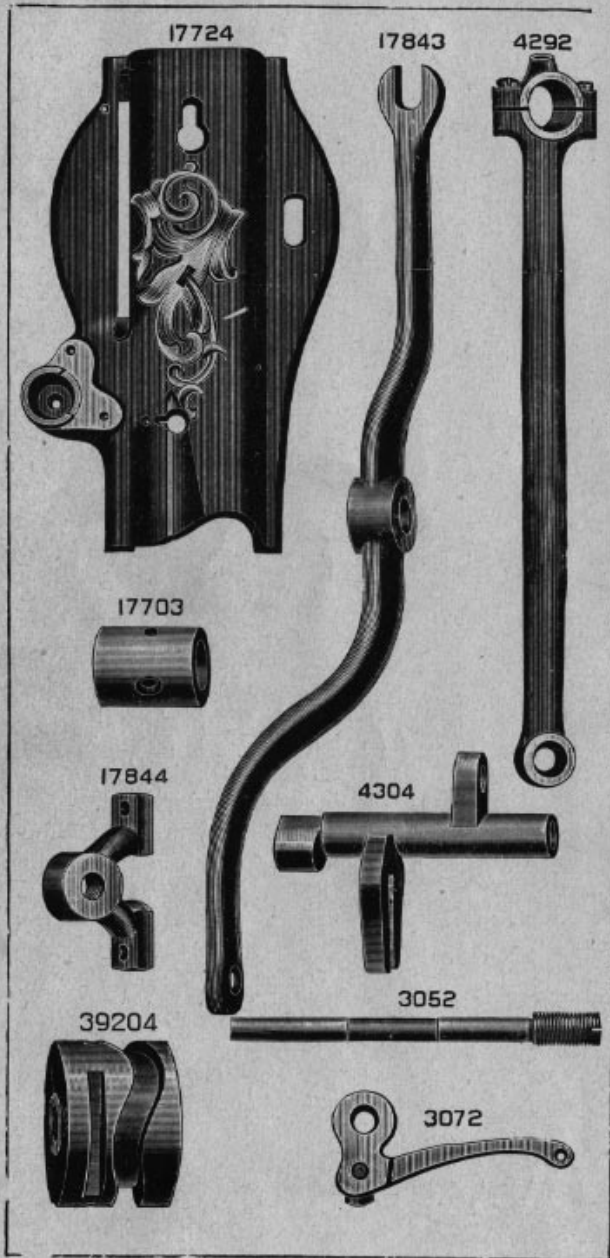
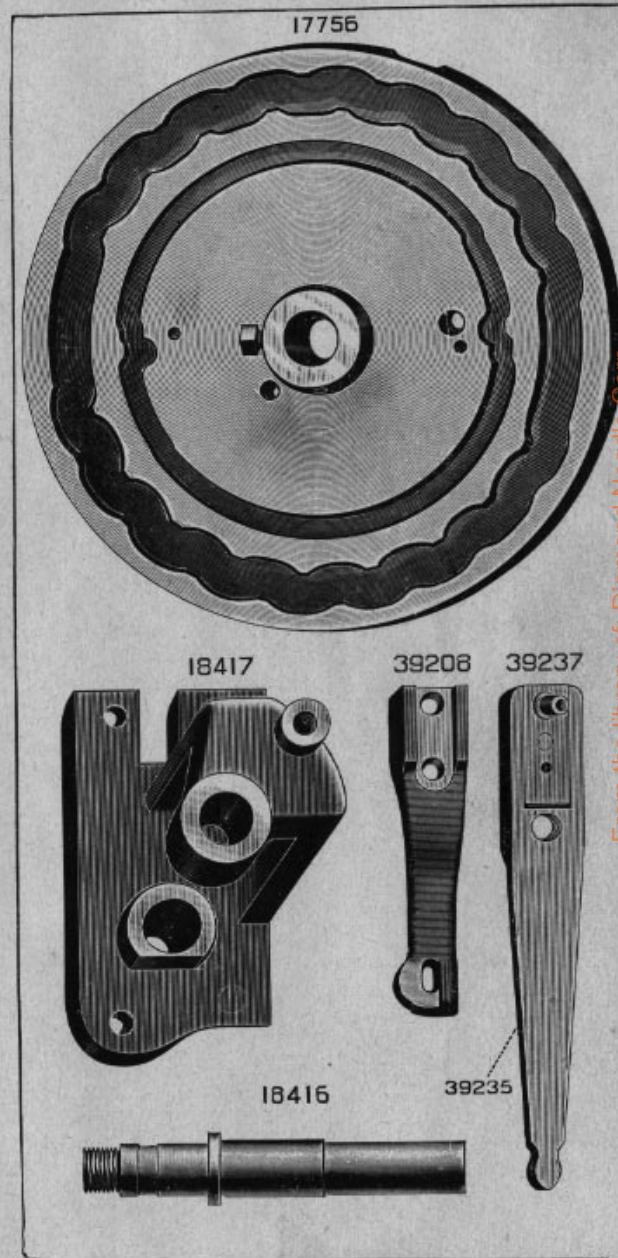

PLATE 3712—ONE-HALF SIZE



From the library of: Diamond Needle Corp

PLATE 3713—ONE-HALF SIZE

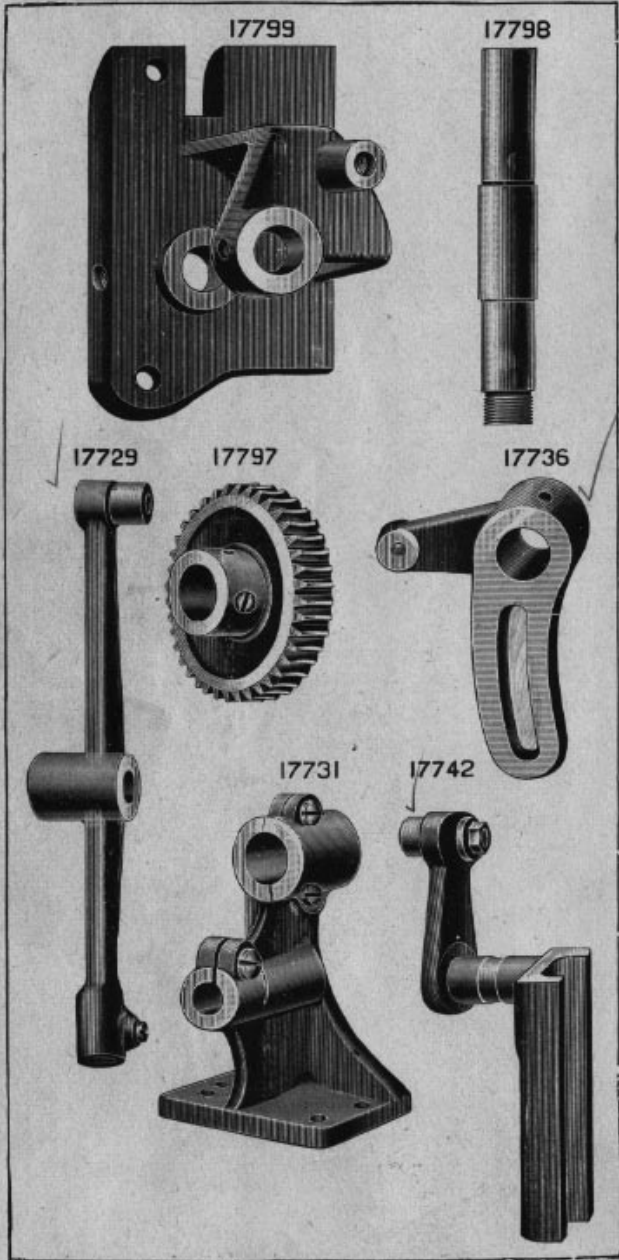
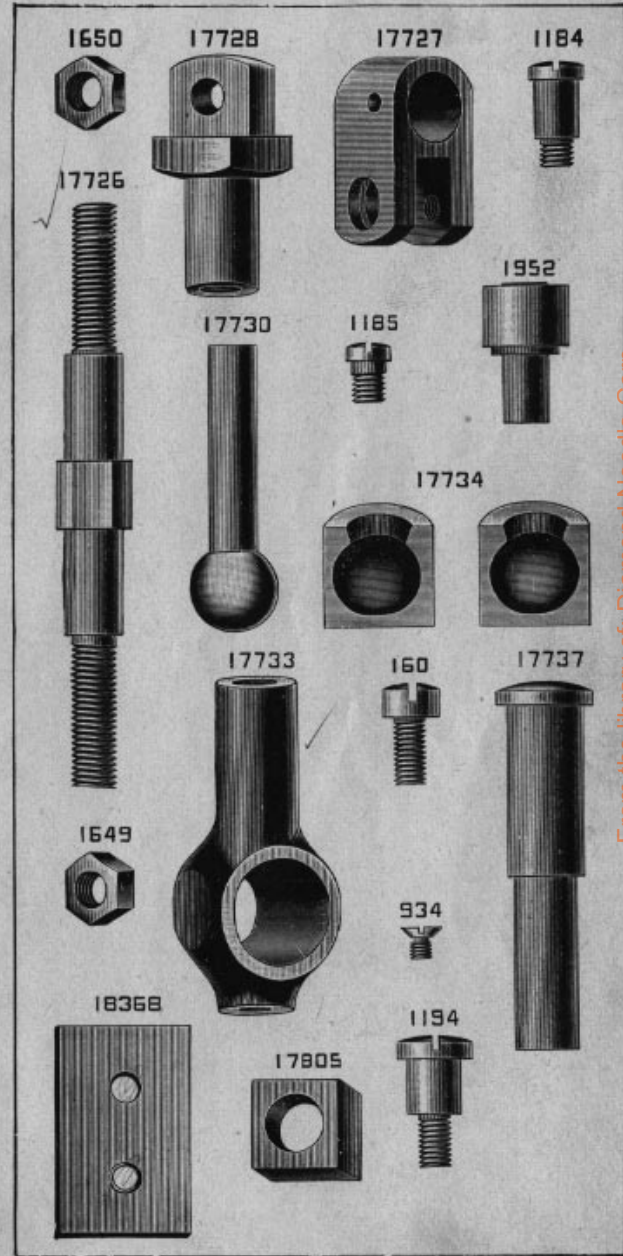

PLATE 3714—FULL SIZE



From the library of Diamond Needle Corp

PLATE 3715—FULL SIZE

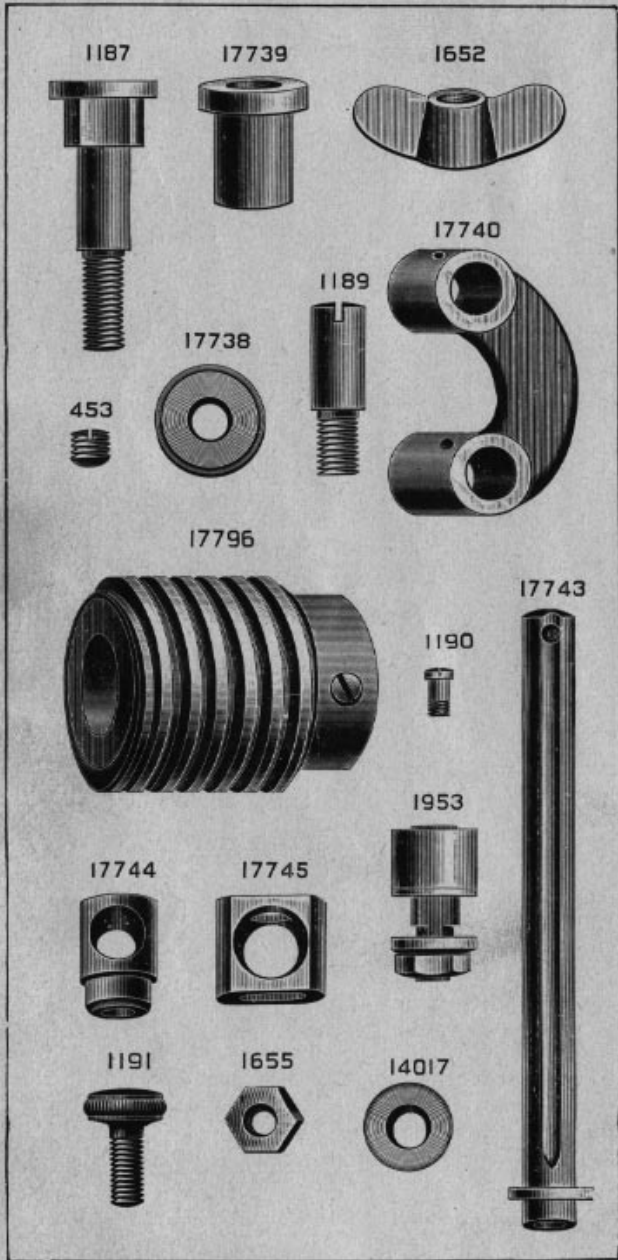
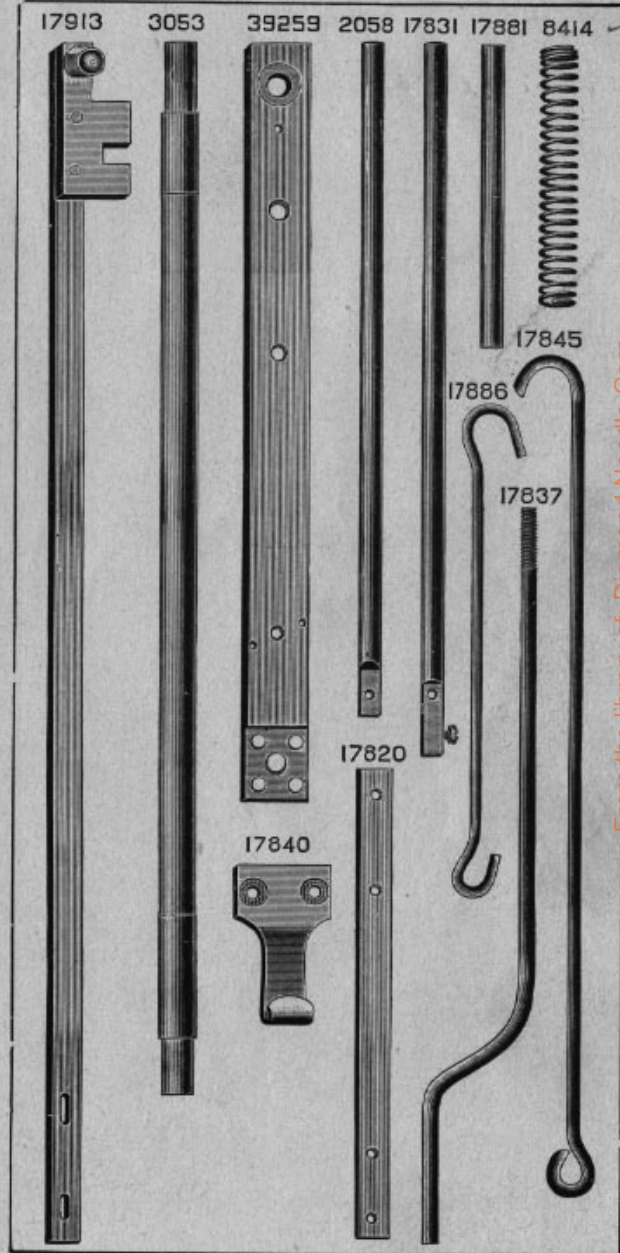

PLATE 3716—ONE-HALF SIZE



From the library of: Diamond Needle Corp

PLATE 3717—FULL SIZE

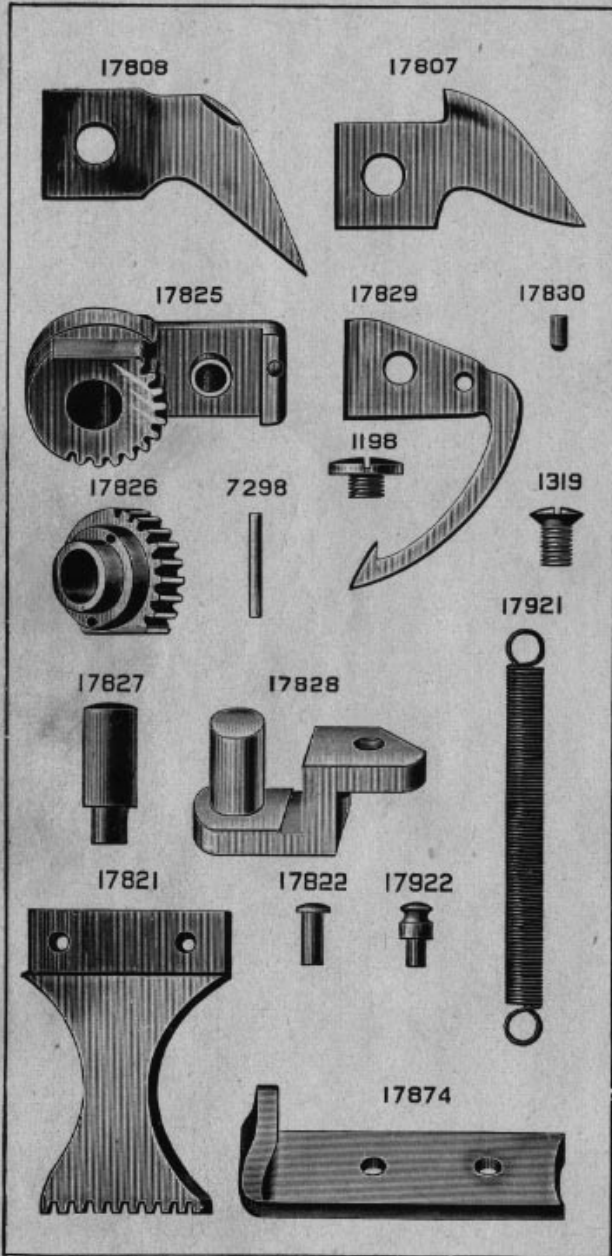

PLATE 3718—FULL SIZE

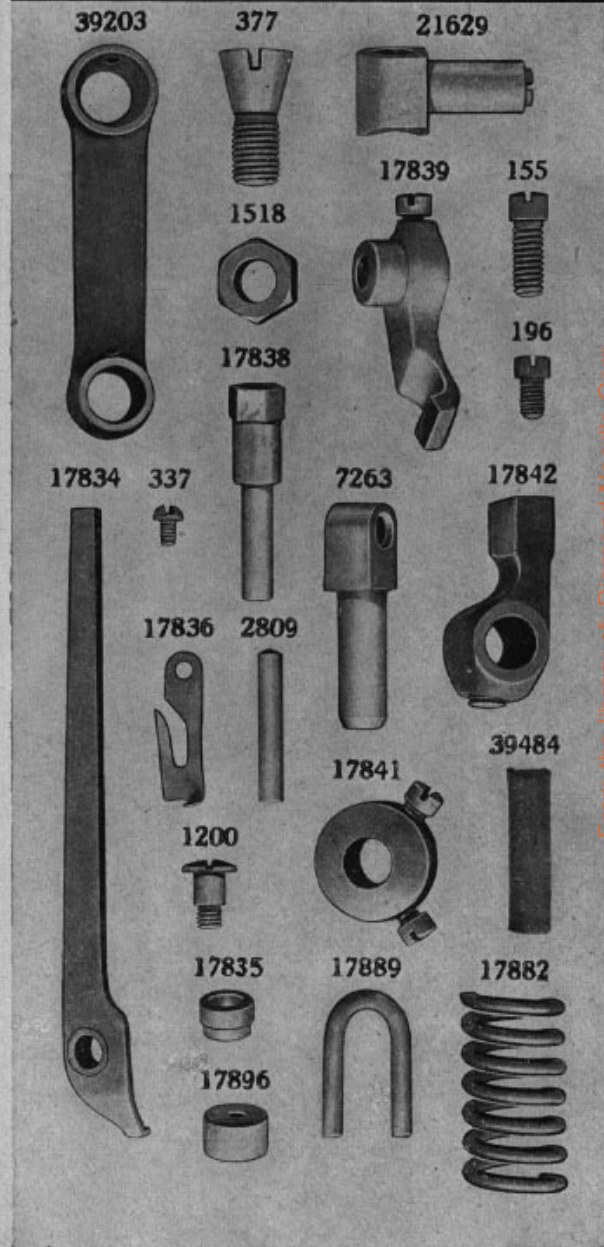

PLATE 3719—FULL SIZE

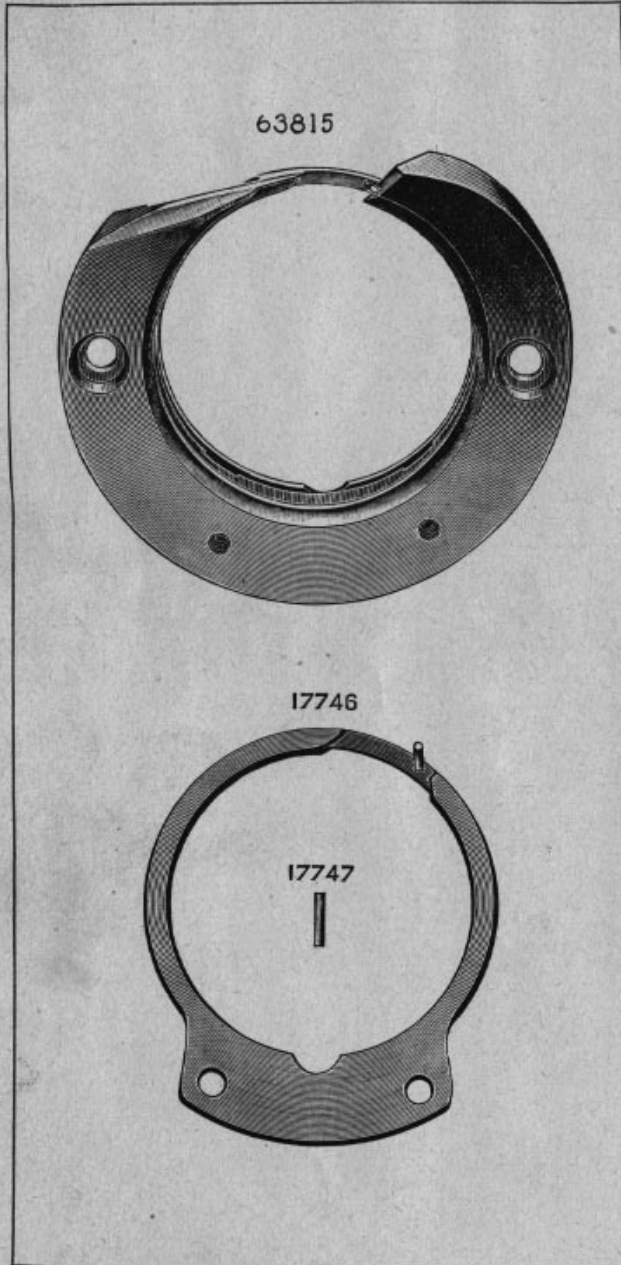
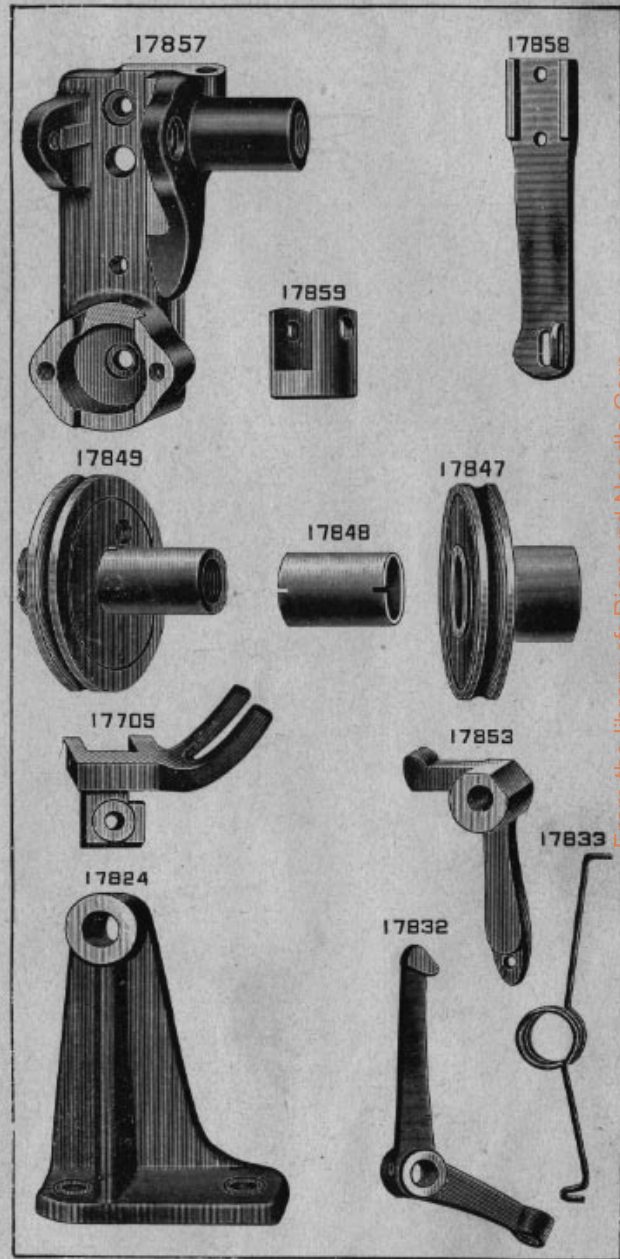

PLATE 3720—ONE-HALF SIZE



From the library of: Diamond Needle Corp

PLATE 3721—FULL SIZE

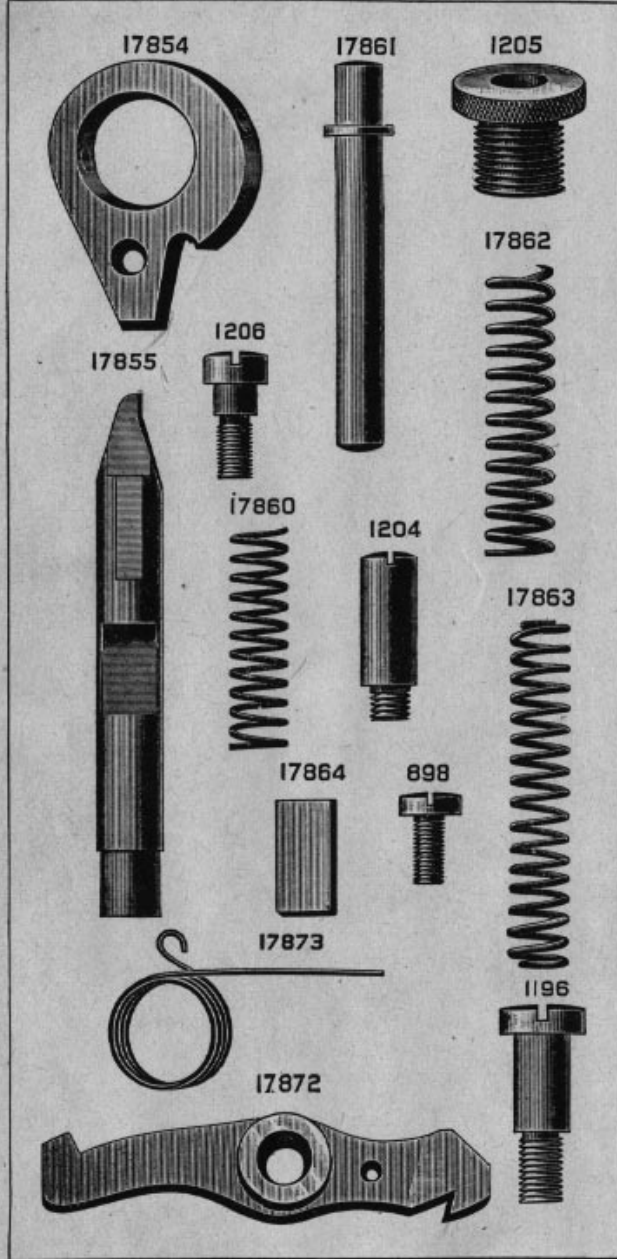
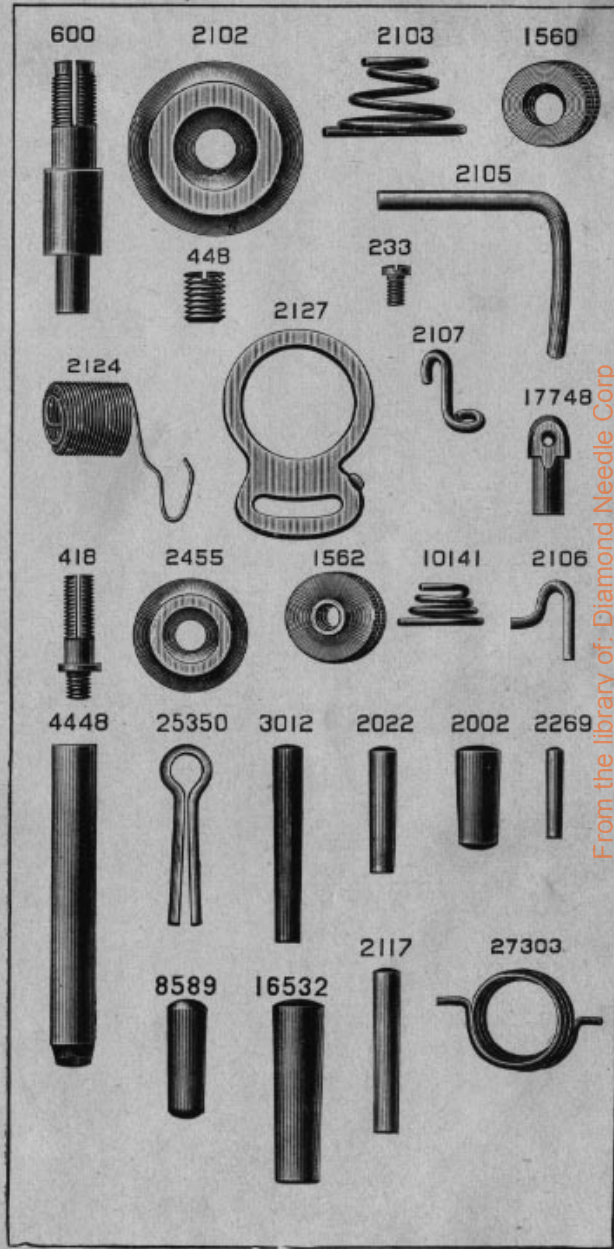

PLATE 3722—FULL SIZE



From the library of: Diamond Needle Corp

PLATE 3723—FULL SIZE

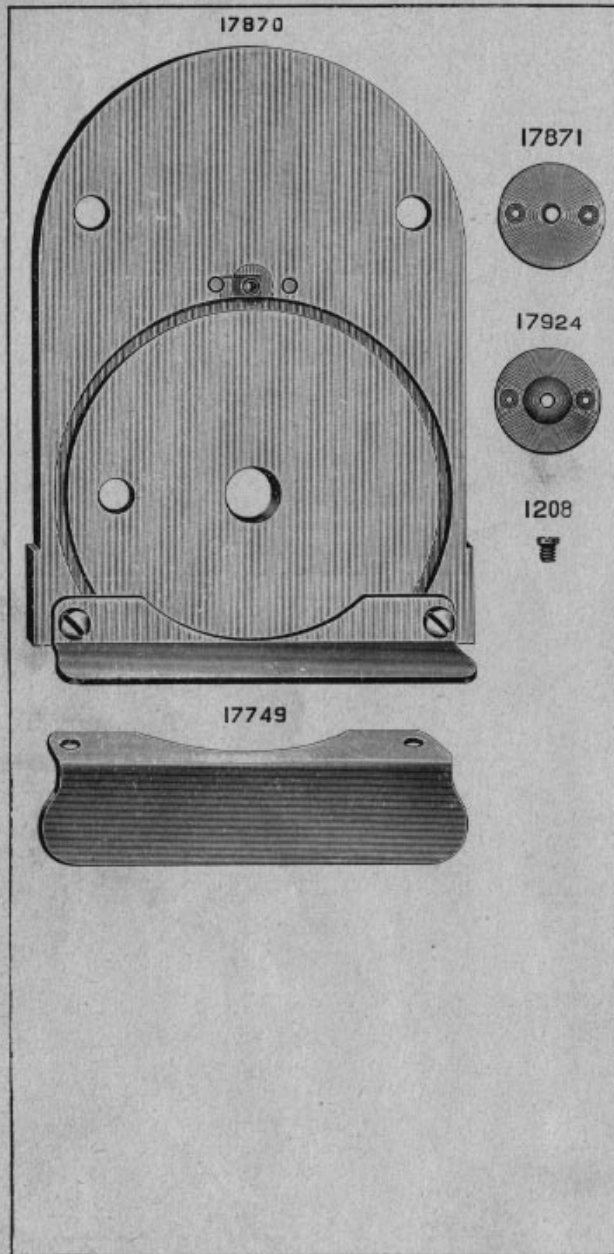
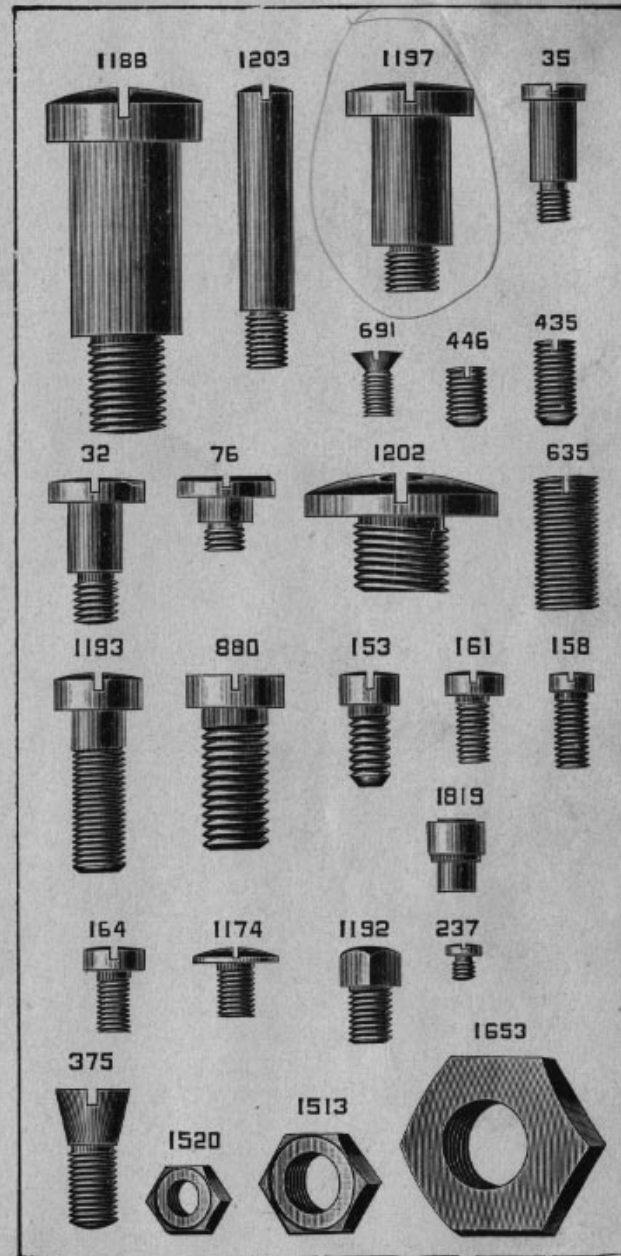

PLATE 3724—FULL SIZE



From the library of Diamond Needle Corp

PLATE 3725—ONE-HALF SIZE

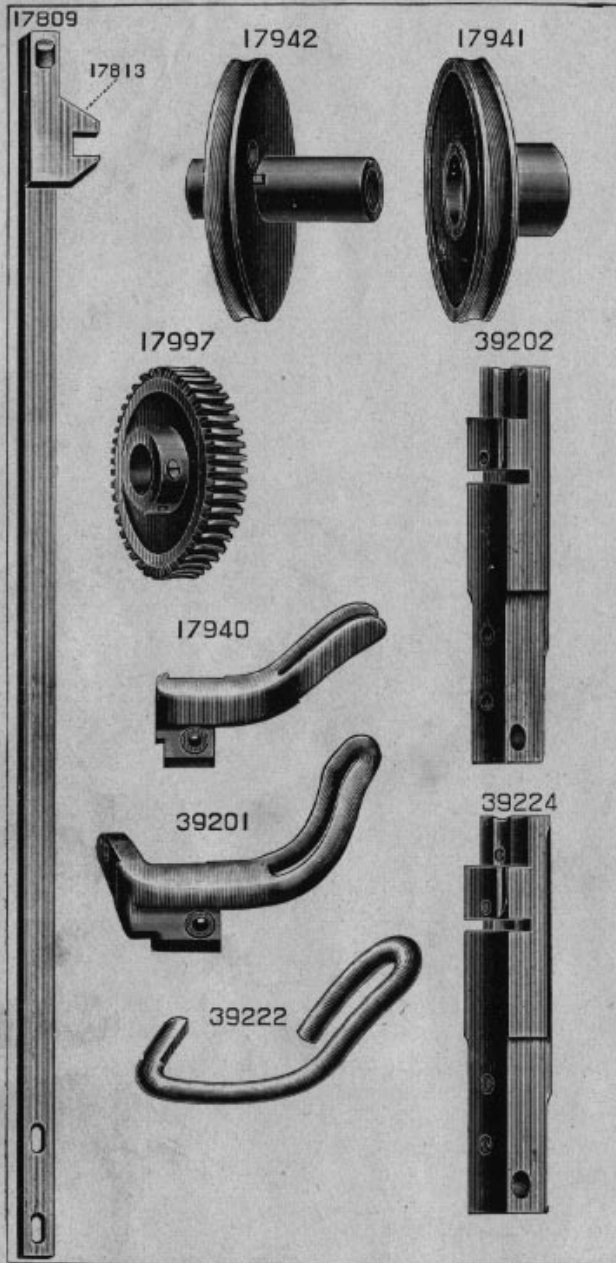
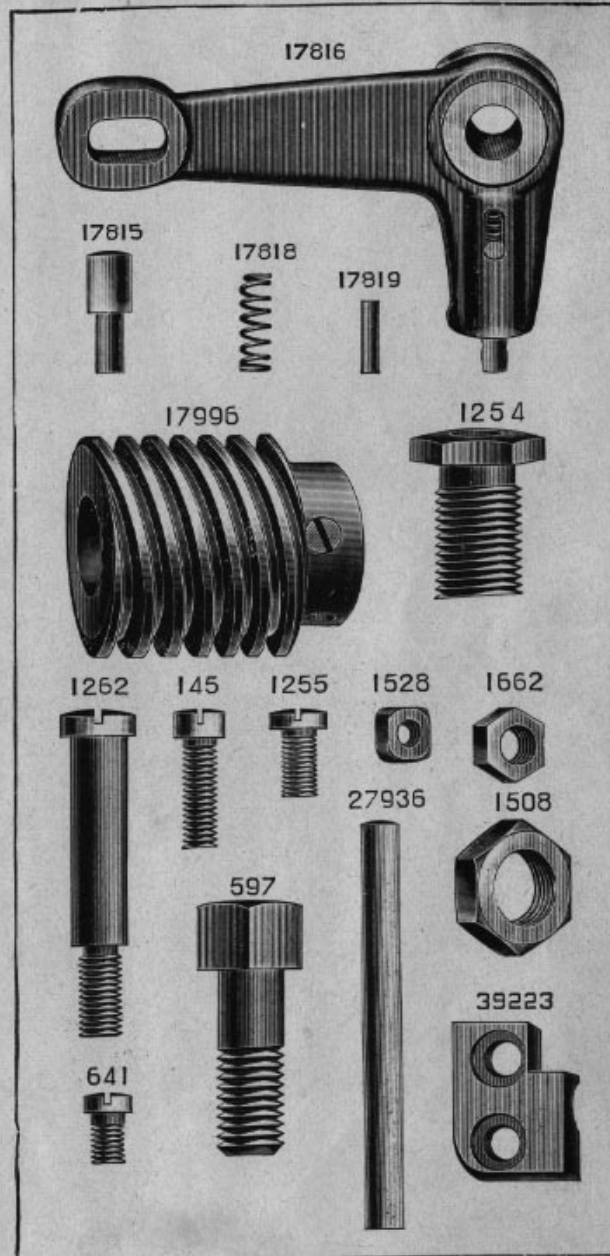

PLATE 3726—FULL SIZE



From the library of: Diamond Needle Corp

PLATE 3727—ONE-HALF SIZE

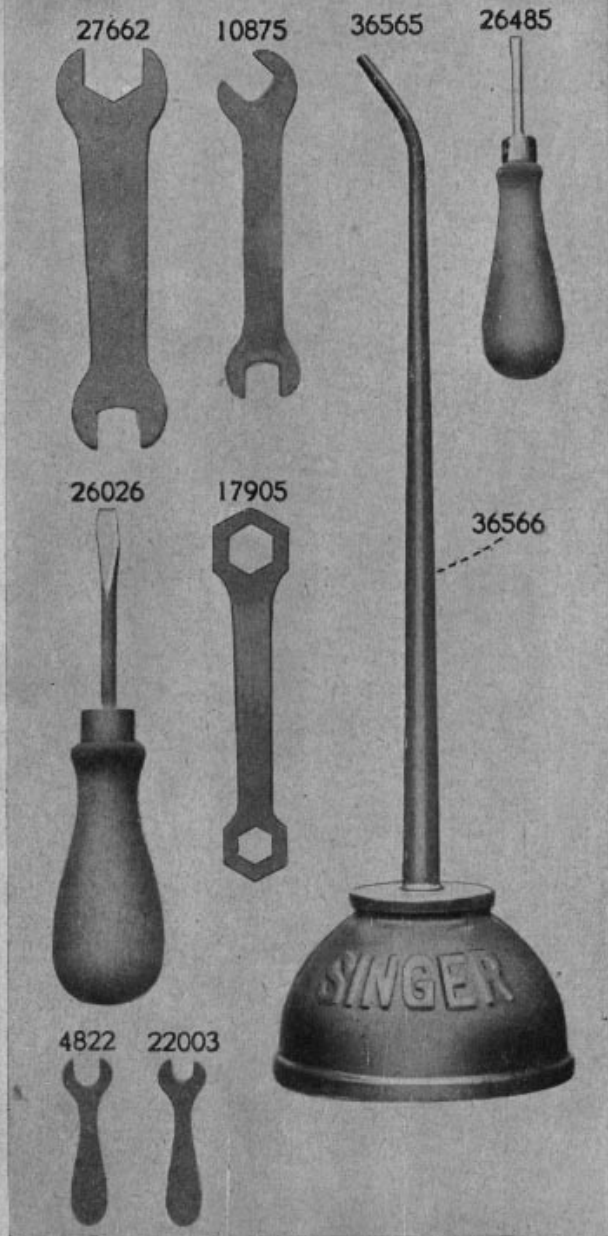
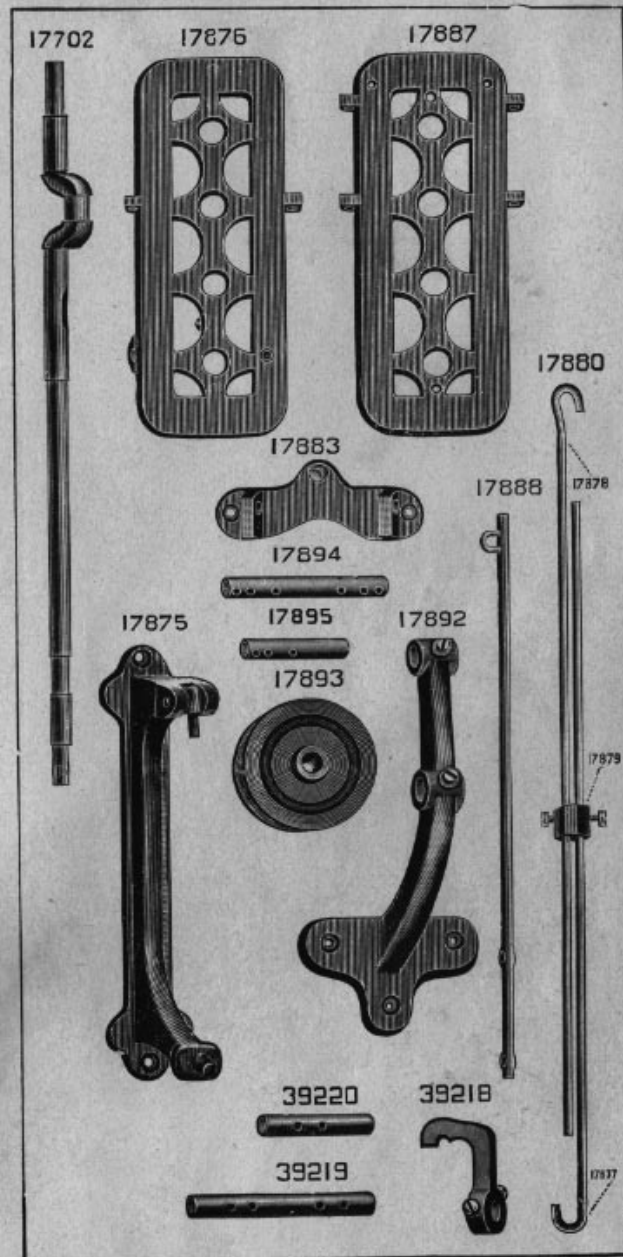

PLATE 3728—ONE-FOURTH SIZE



From the library of: Diamond Needle Corp

PLATE 3729—FULL SIZE

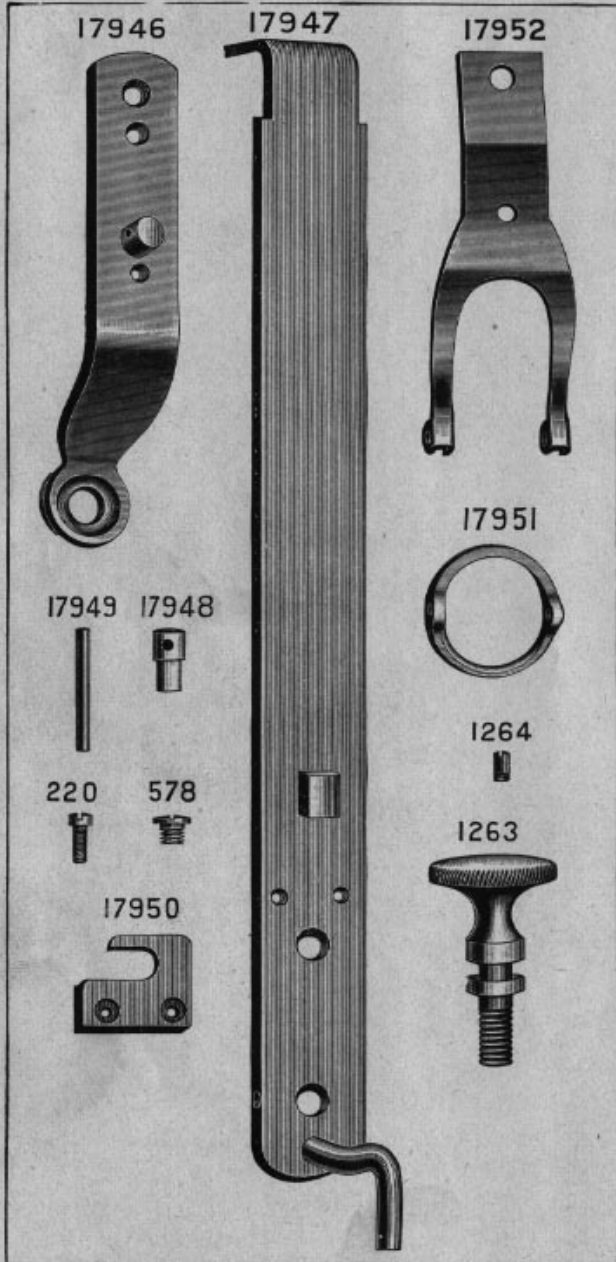
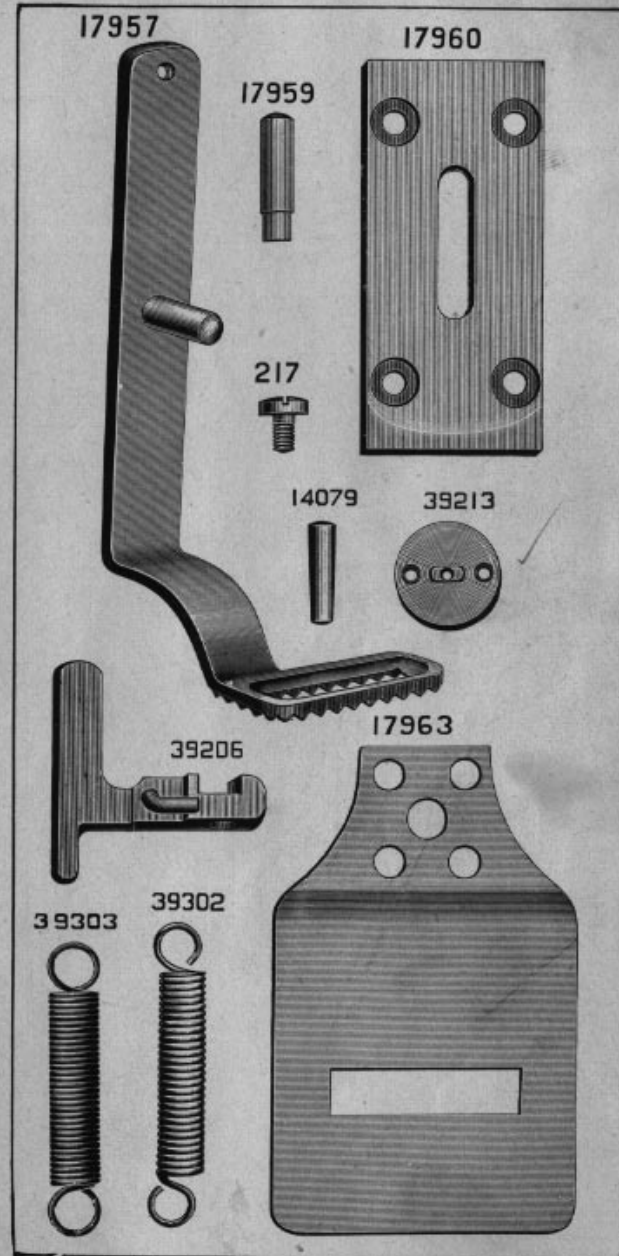

PLATE 3731—FULL SIZE



From the library of: Diamond Needle Corp

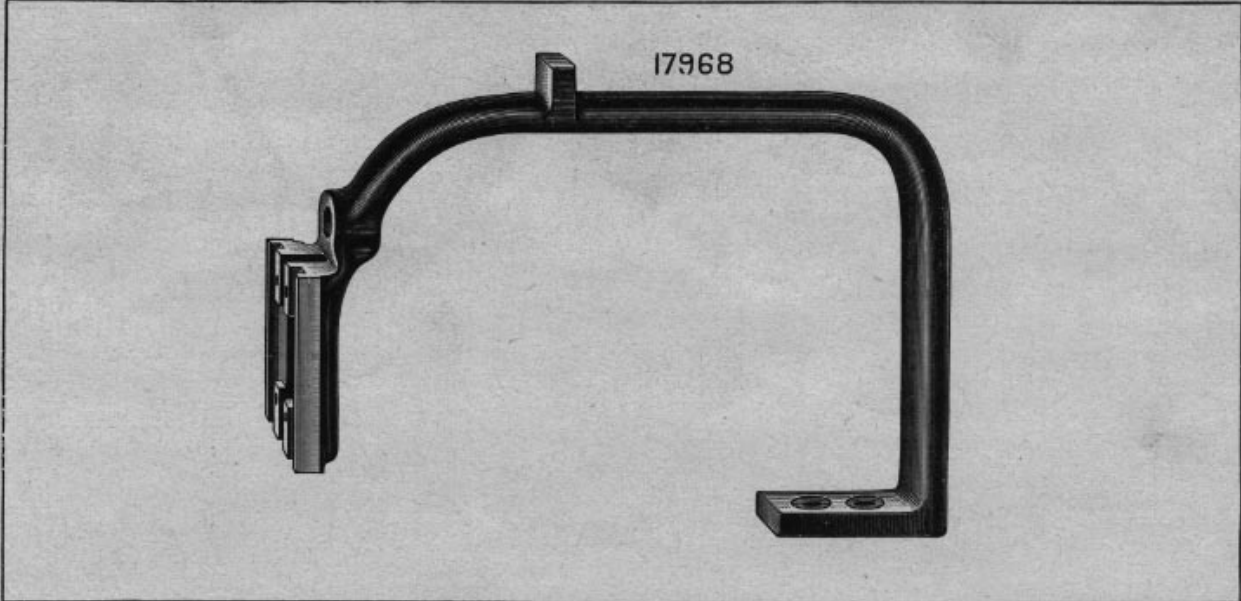

PLATE 3732—ONE-HALF SIZE

PLATE 3733—FULL SIZE

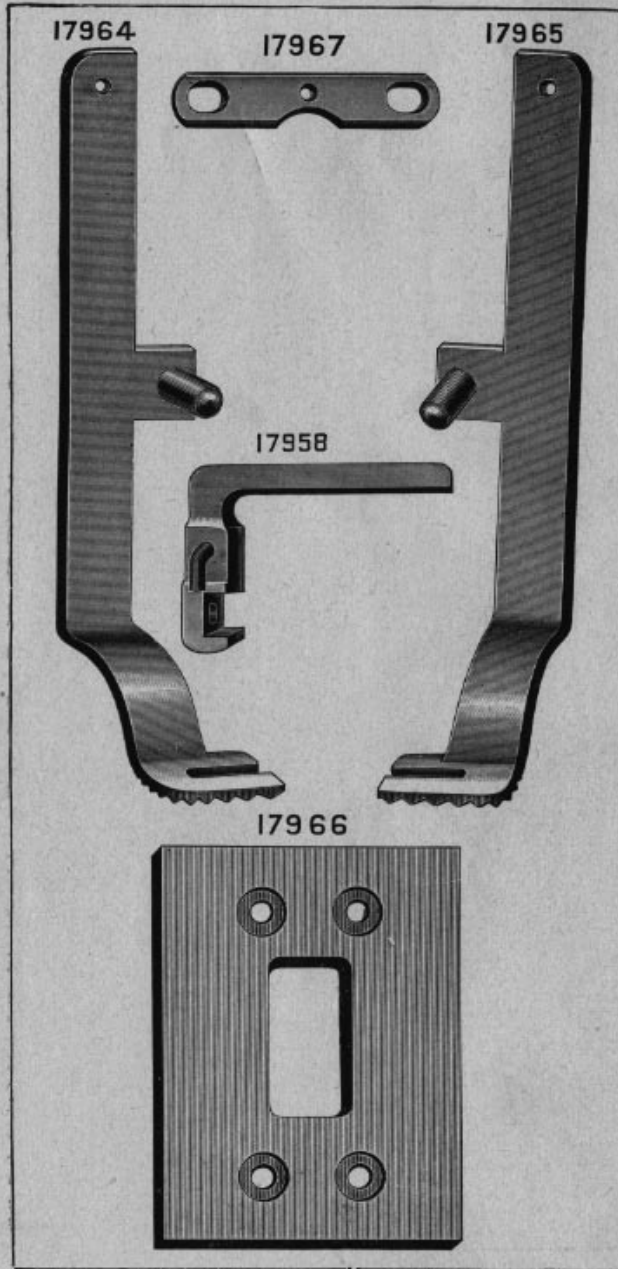

PLATE 3735—FULL SIZE

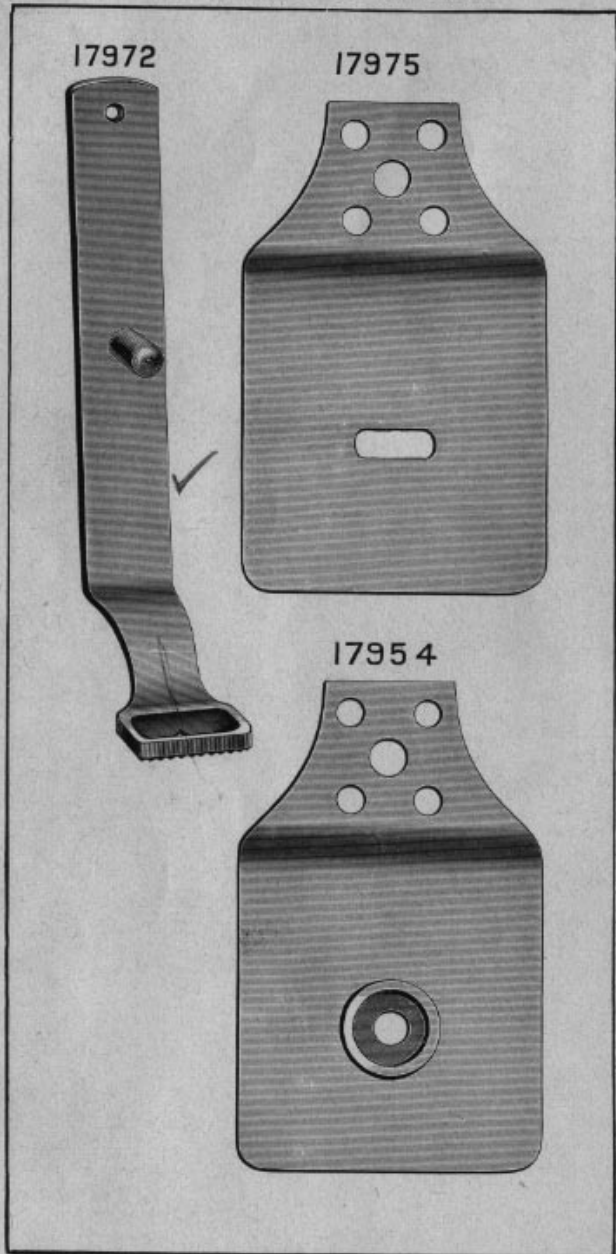

PLATE 3736—ONE-HALF SIZE

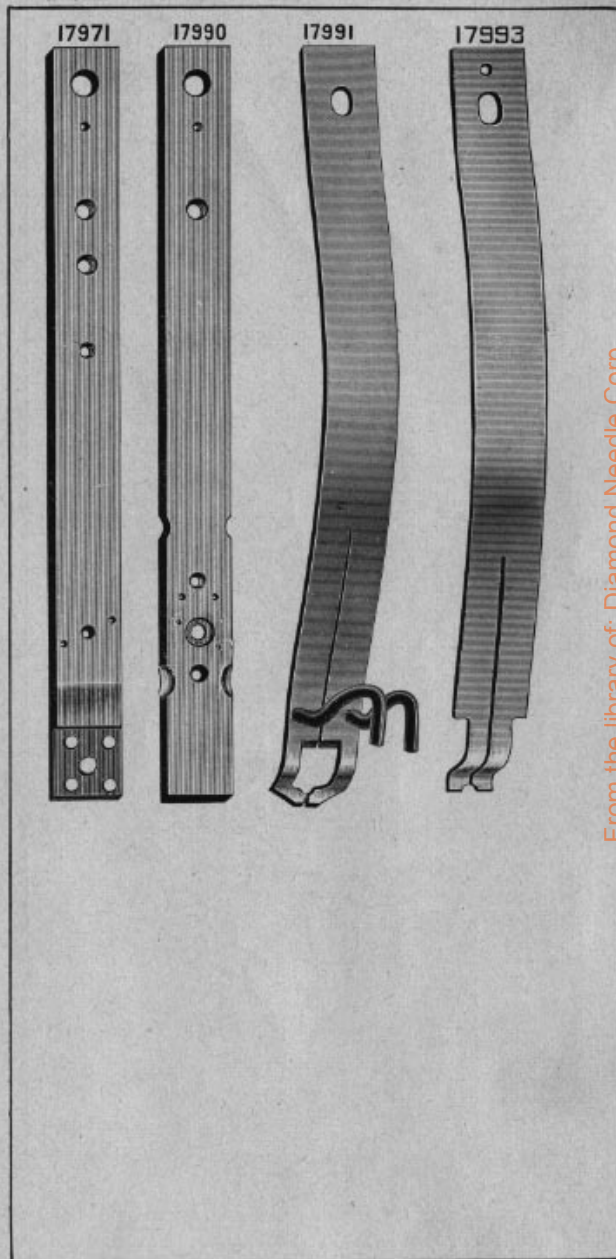

PLATE 3737—FULL SIZE

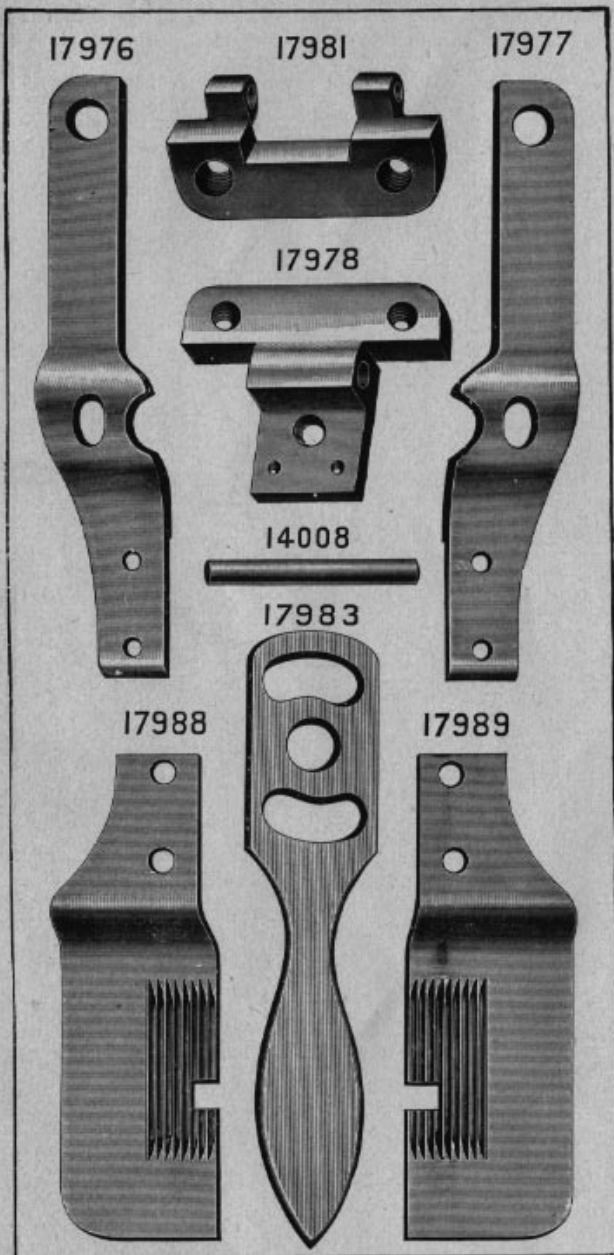
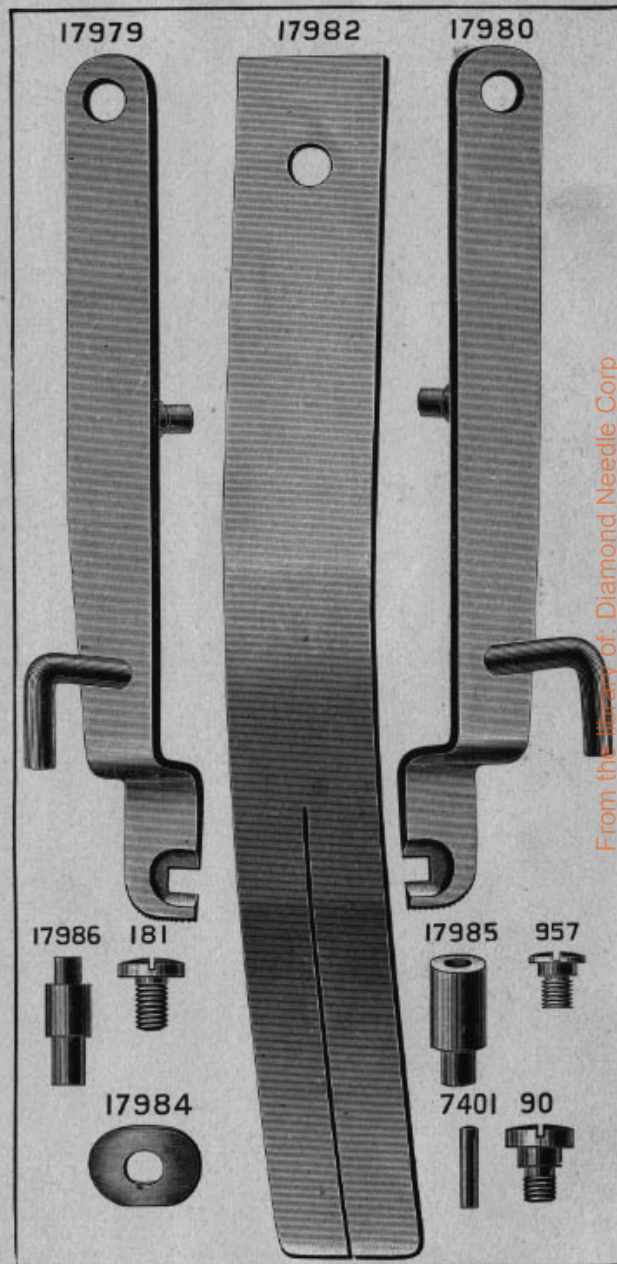

PLATE 3738—FULL SIZE



From the library of: Diamond Needle Corp

PLATE 3739—ONE-HALF SIZE

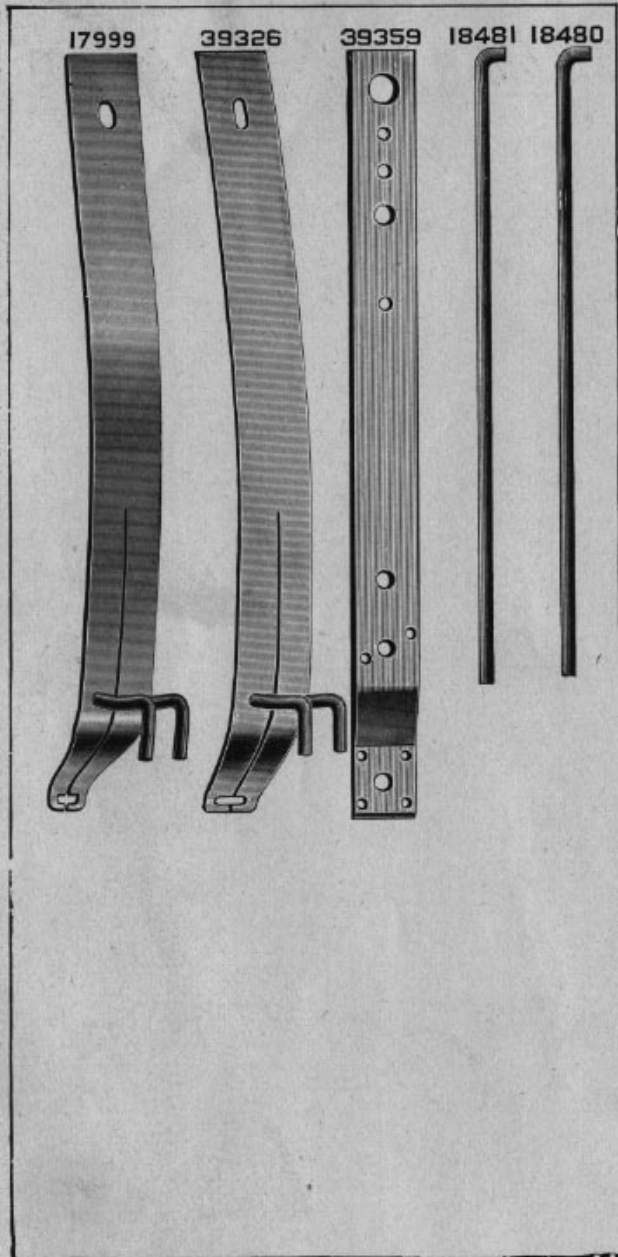

PLATE 3740—FULL SIZE

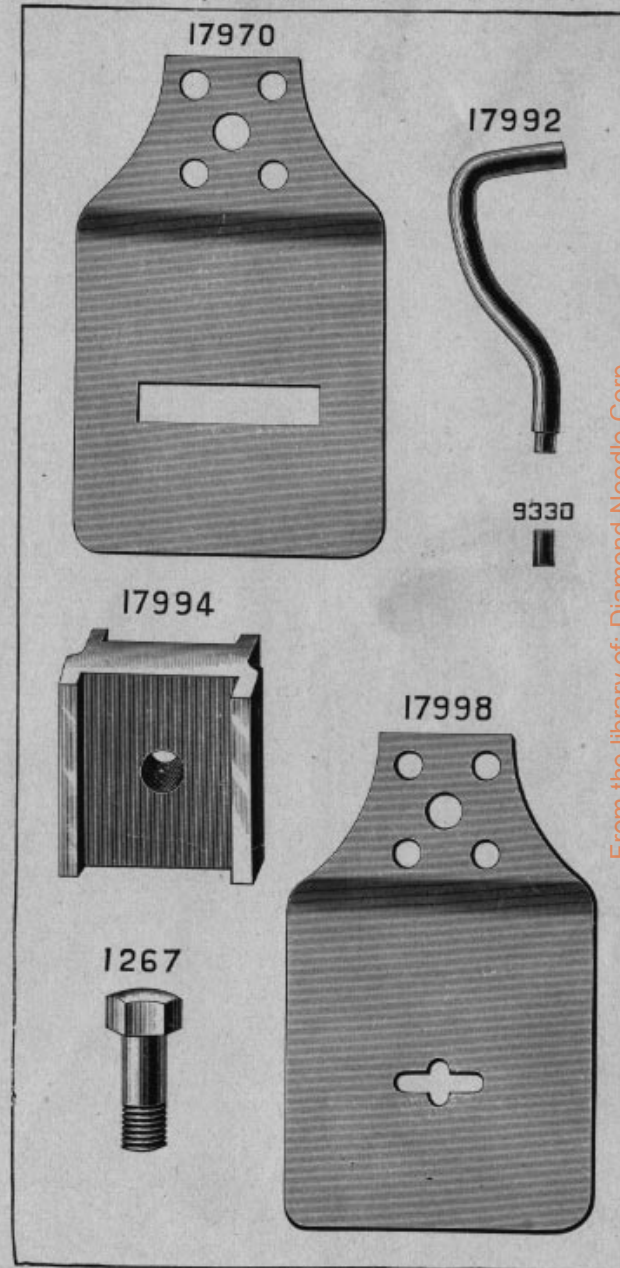
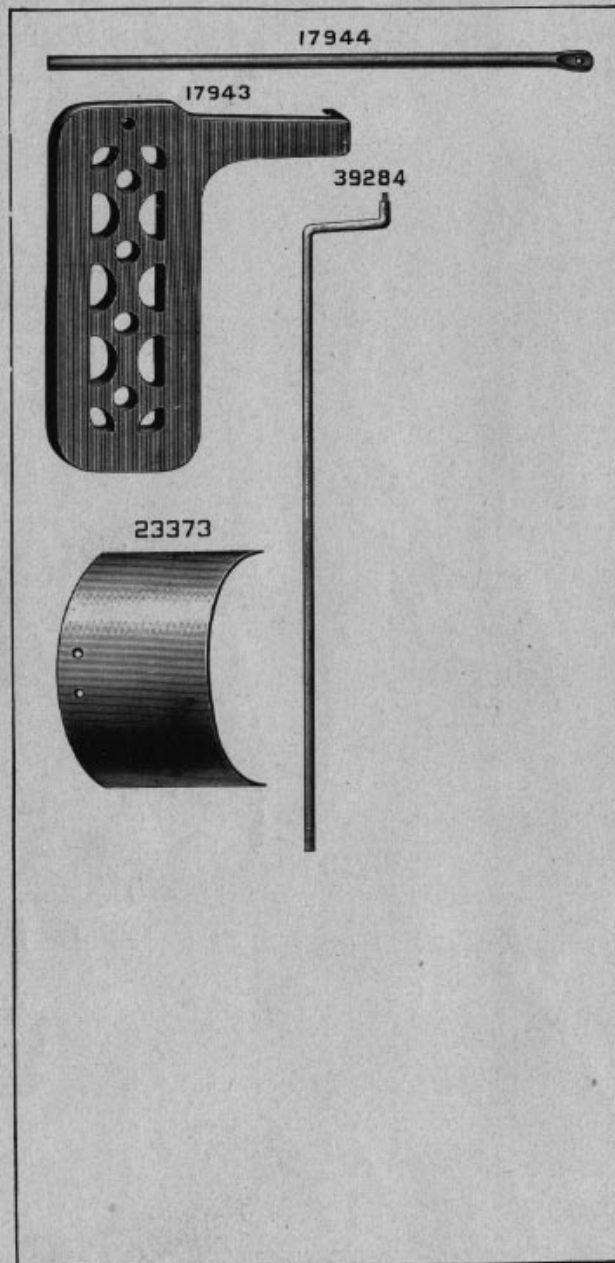

PLATE 3741—ONE-FOURTH SIZE



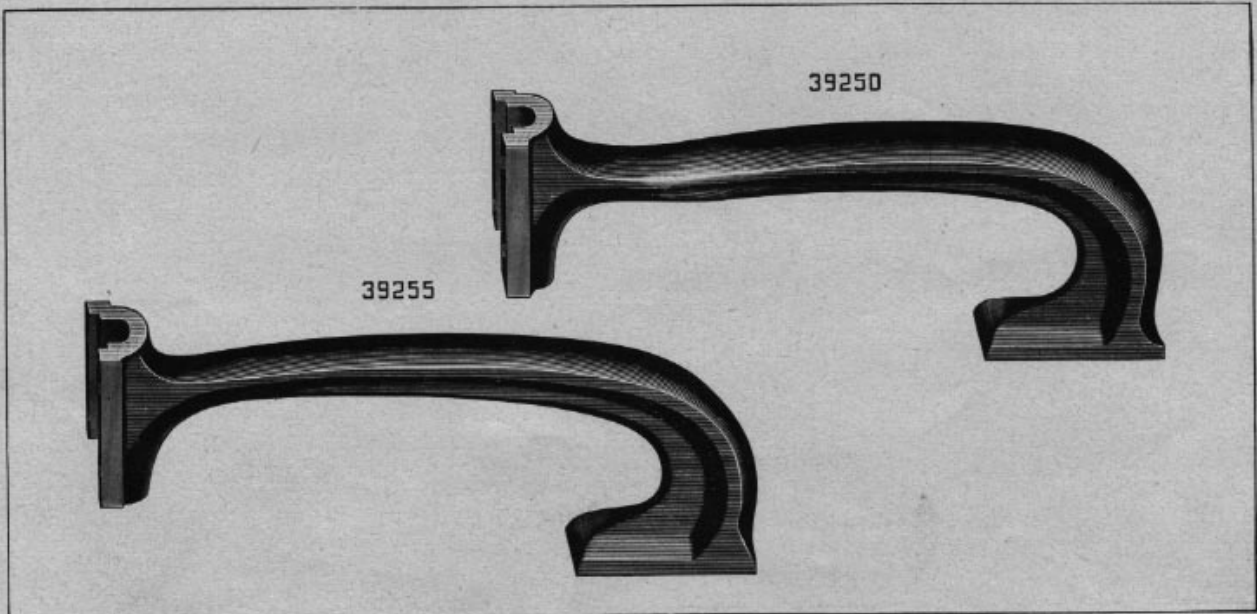

PLATE 3742—ONE-HALF SIZE

PLATE 3743—ONE-HALF SIZE

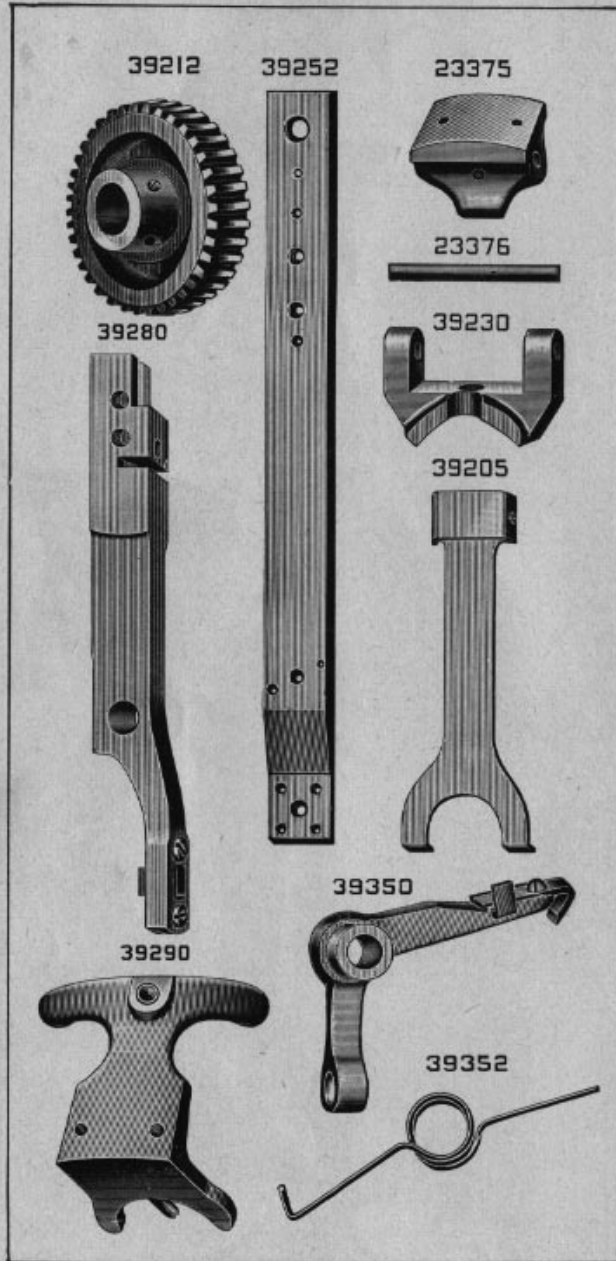

PLATE 3744—FULL SIZE

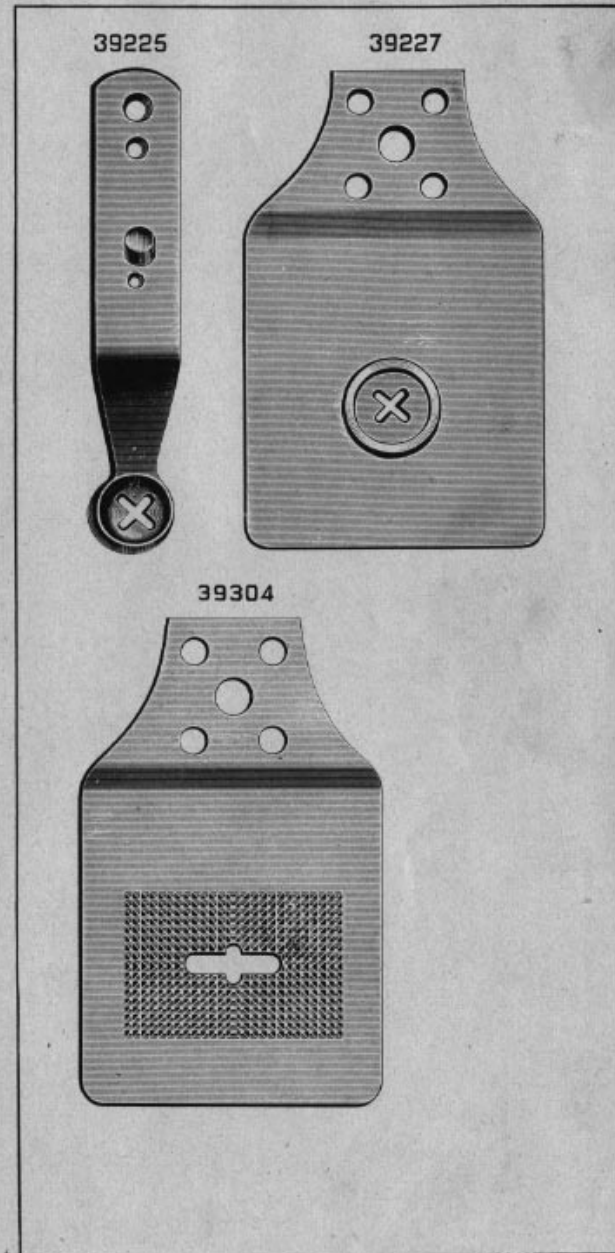

PLATE 3745—FULL SIZE

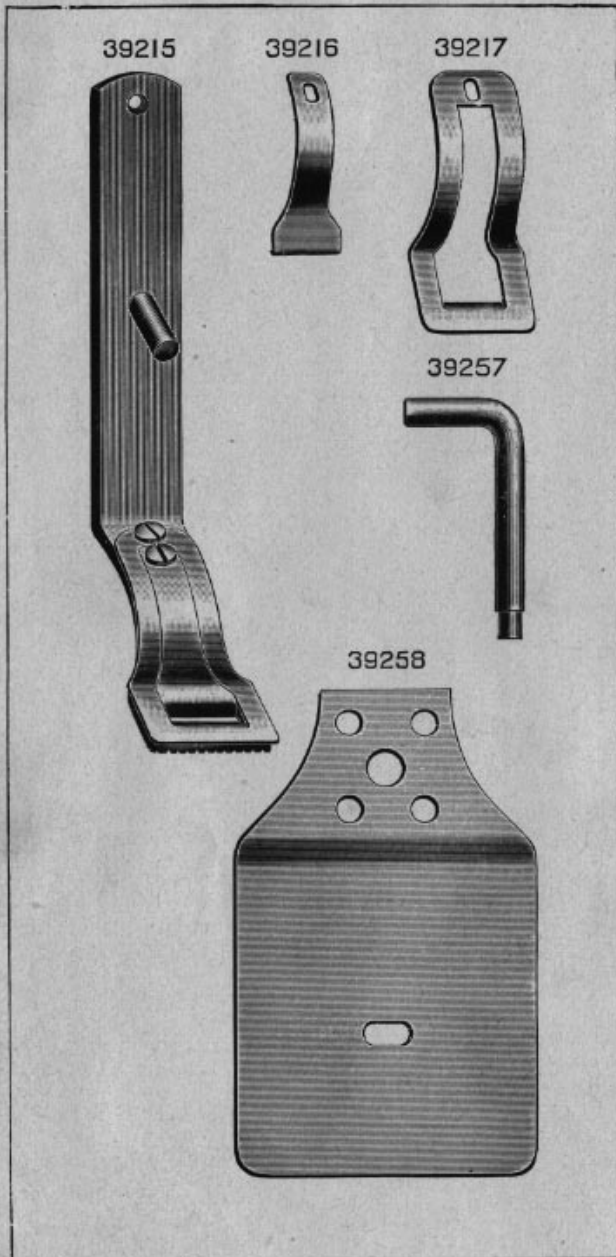
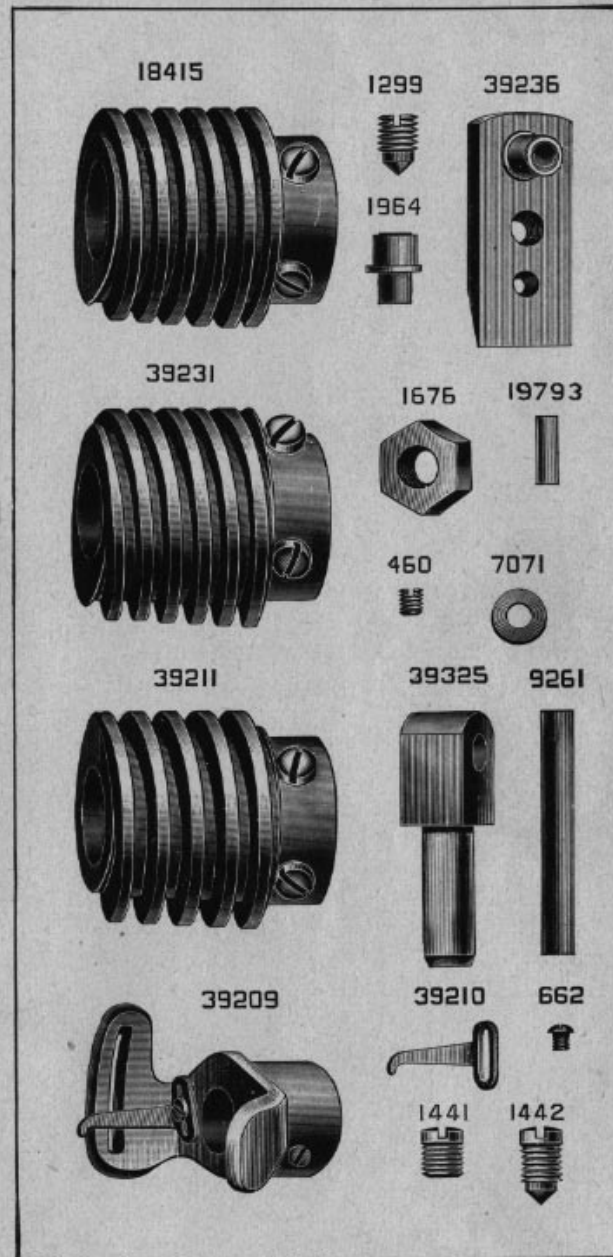

PLATE 3746—FULL SIZE



From the library of: Diamond Needle Corp

PLATE 3747—FULL SIZE

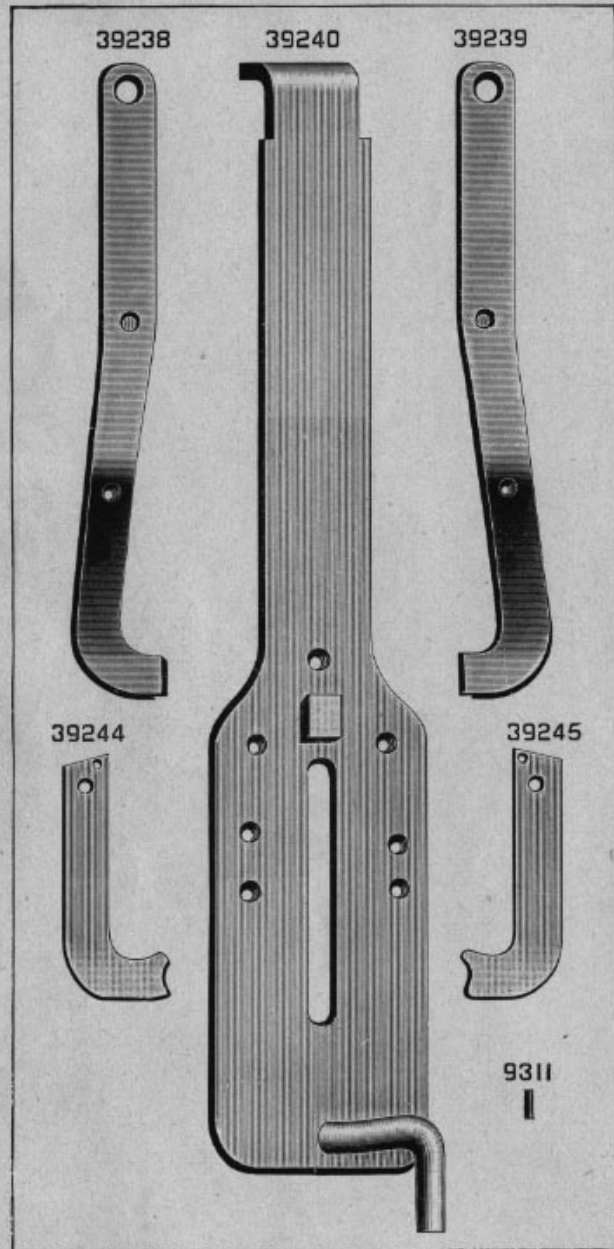

PLATE 3748—FULL SIZE

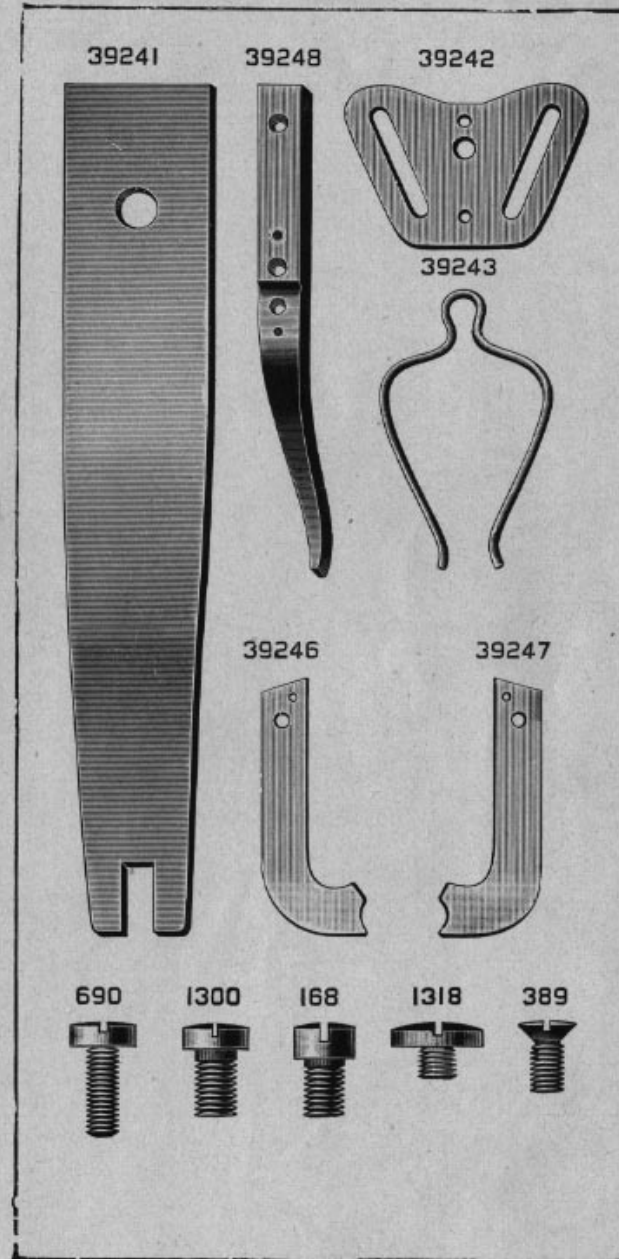
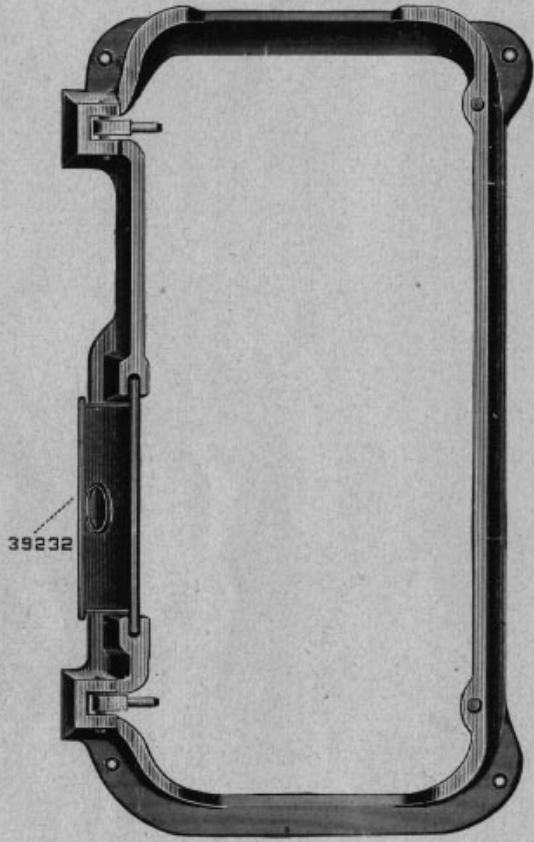

PLATE 3749—ONE-FOURTH SIZE

39233



39232

PLATE 3750—ONE-FOURTH SIZE

39234



PLATE 3752—ONE-HALF SIZE

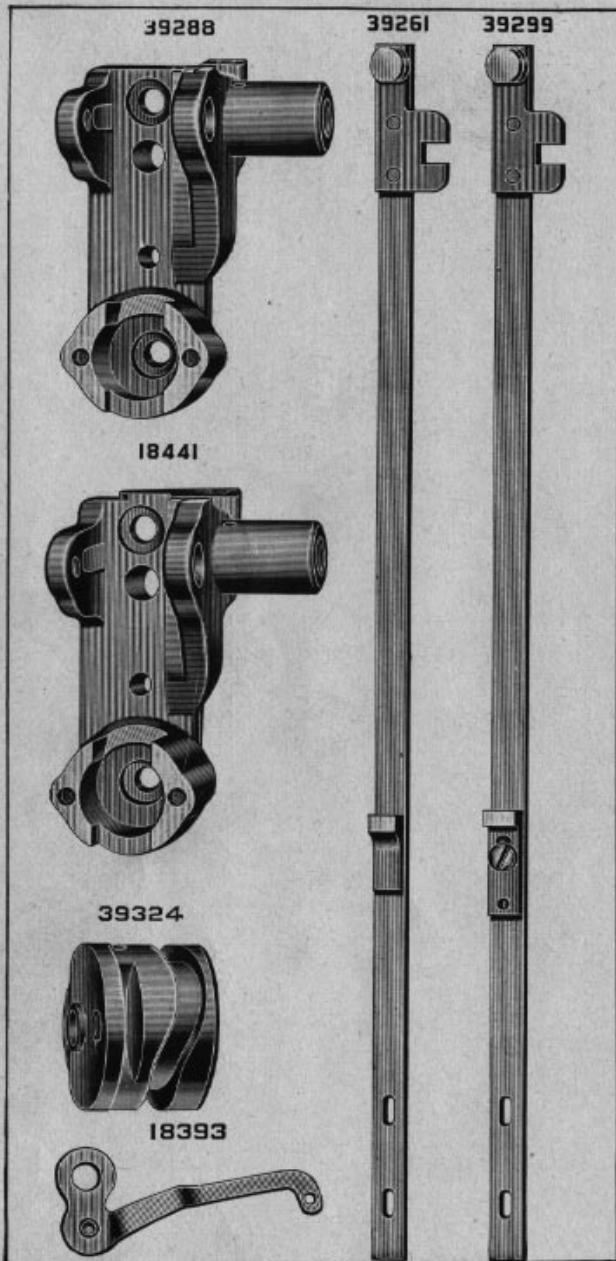
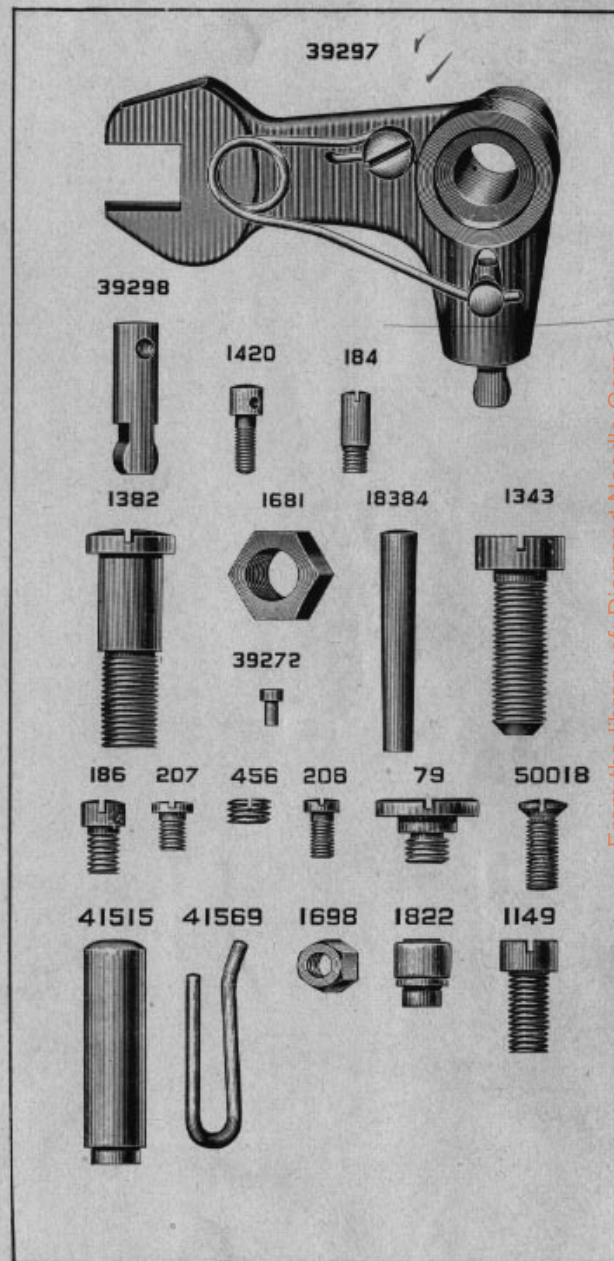

PLATE 3753—FULL SIZE



From the library of: Diamond Needle Corp

PLATE 3754—FULL SIZE

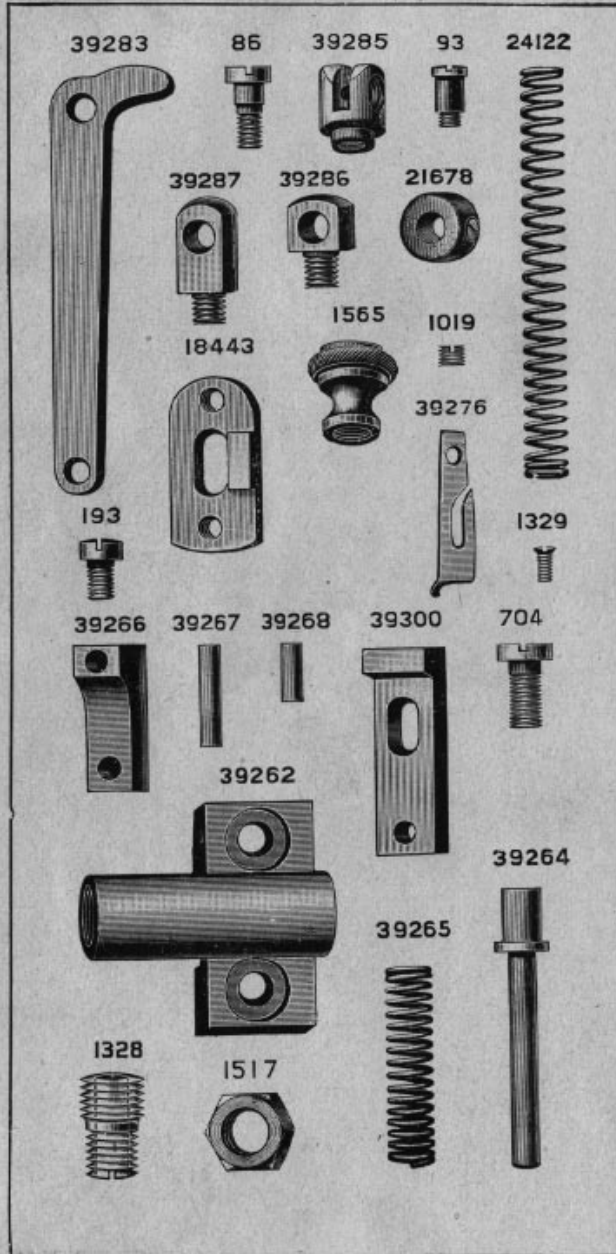

PLATE 3755—FULL SIZE

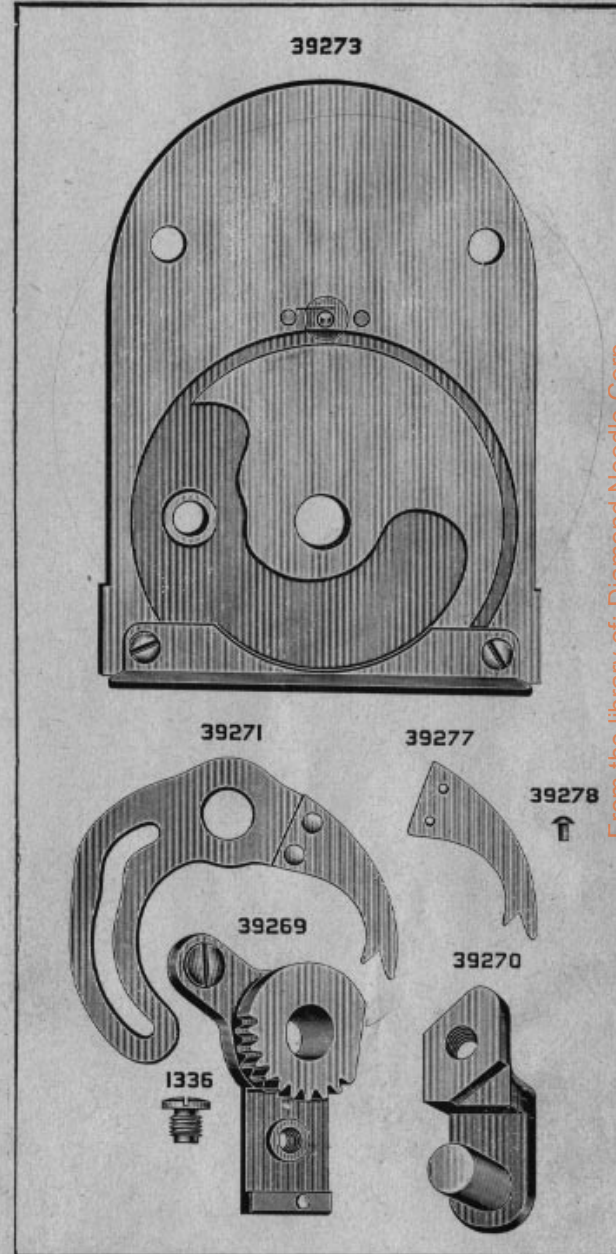
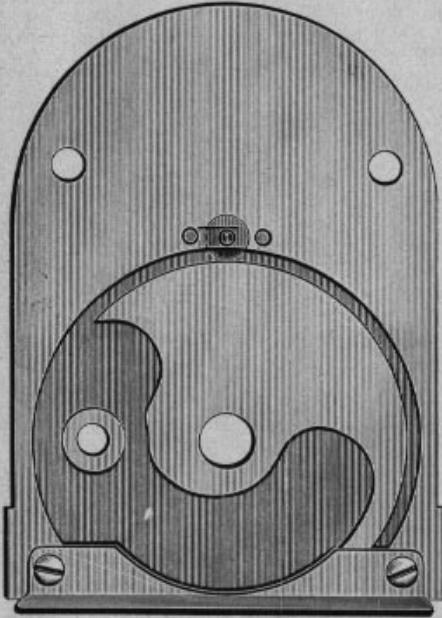

PLATE 3756—FULL SIZE

39292



39291

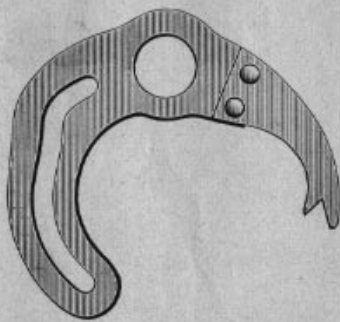
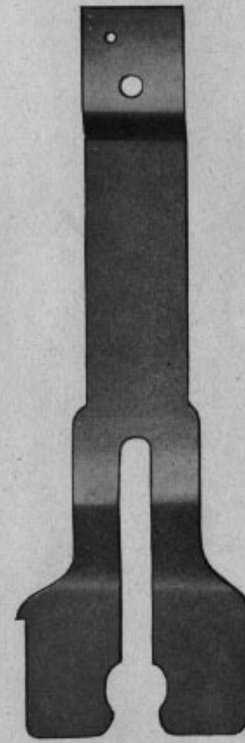

PLATE 3757—FULL SIZE

39340



39315



39314



39317



9558



39316



39342

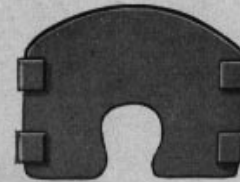

39318



PLATE 3758—ONE-HALF SIZE

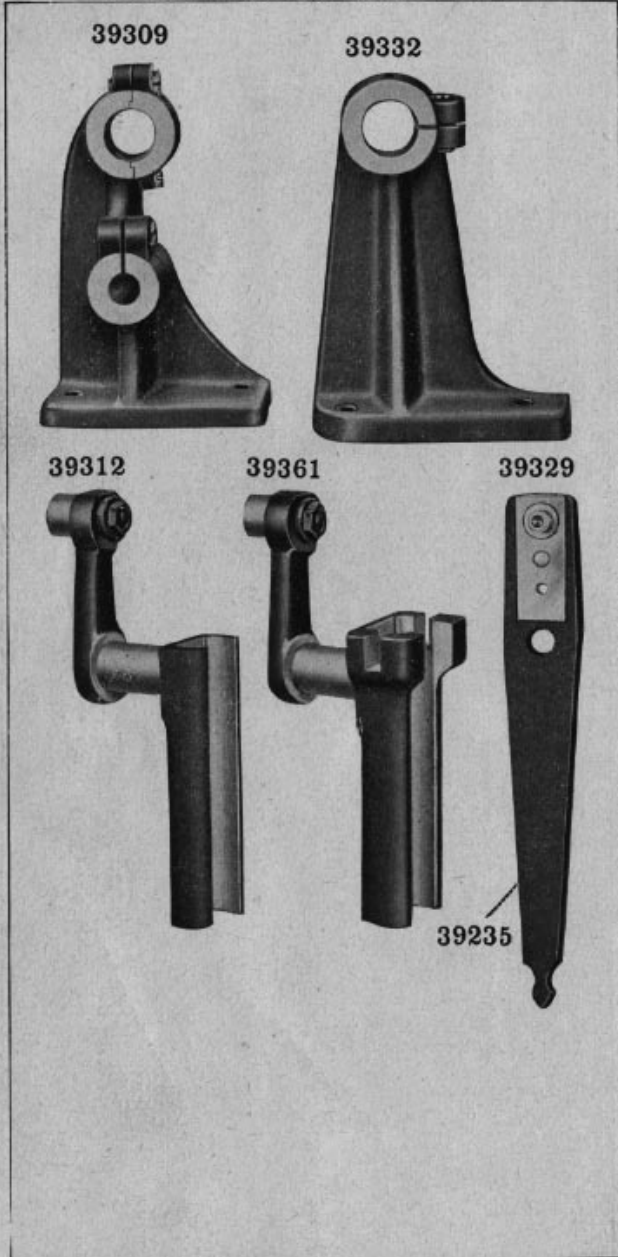
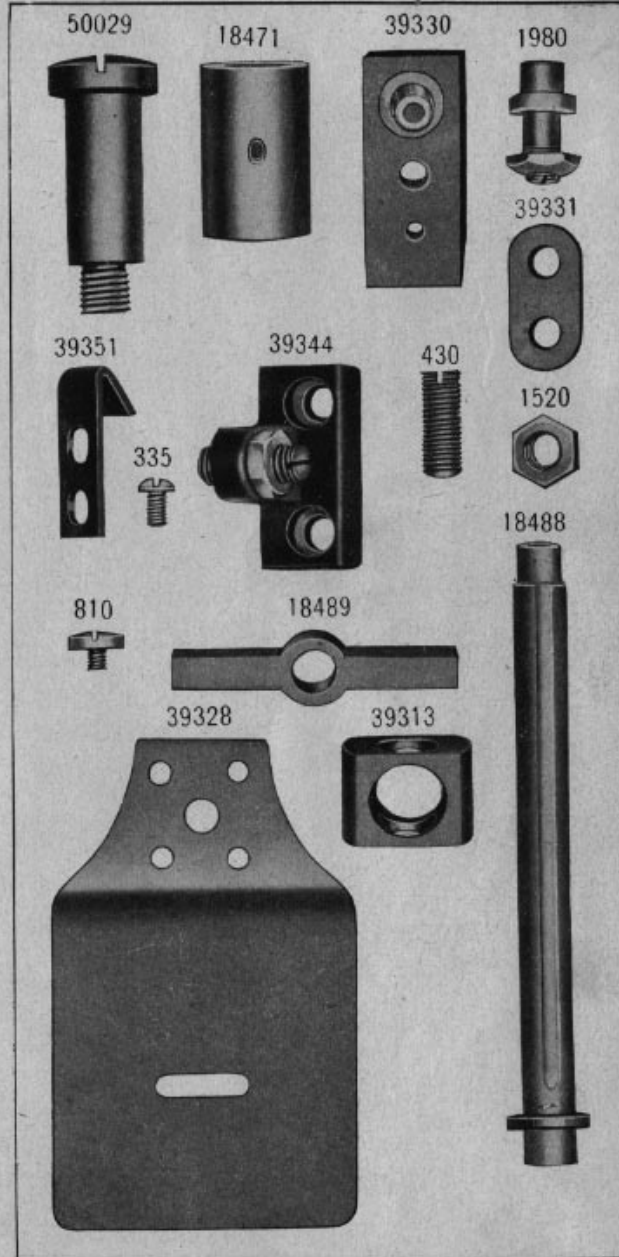

PLATE 3759—FULL SIZE



From the library of: Diamond Needle Corp

PLATE 3760—ONE-HALF SIZE

39346

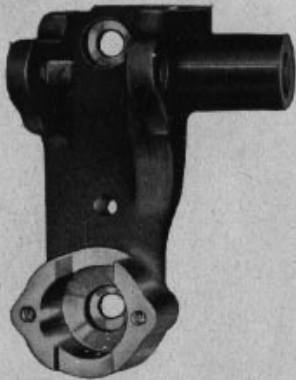

39345

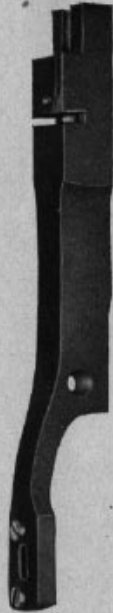

39348

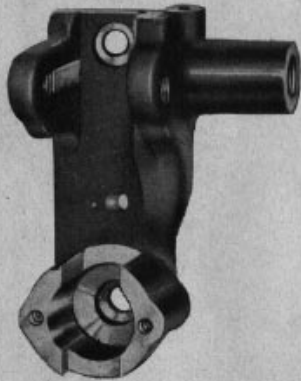

39343



PLATE 3761—FULL SIZE

39336

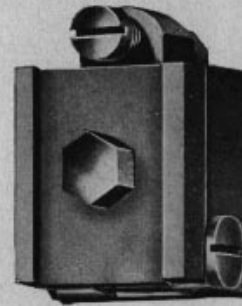

39333



39334



39335

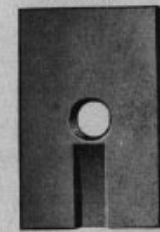

50048

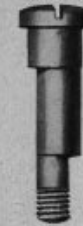

129



1178



1300



1654



From the library of: Diamond Needle Corp

PLATE 3762—FULL SIZE

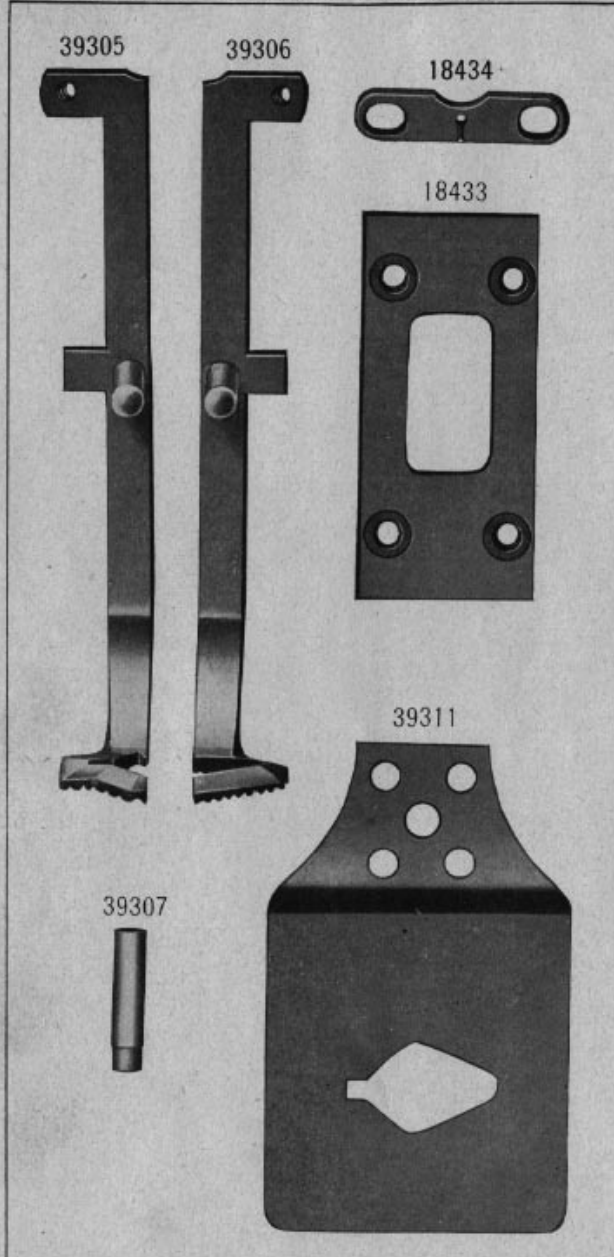

PLATE 3764—FULL SIZE

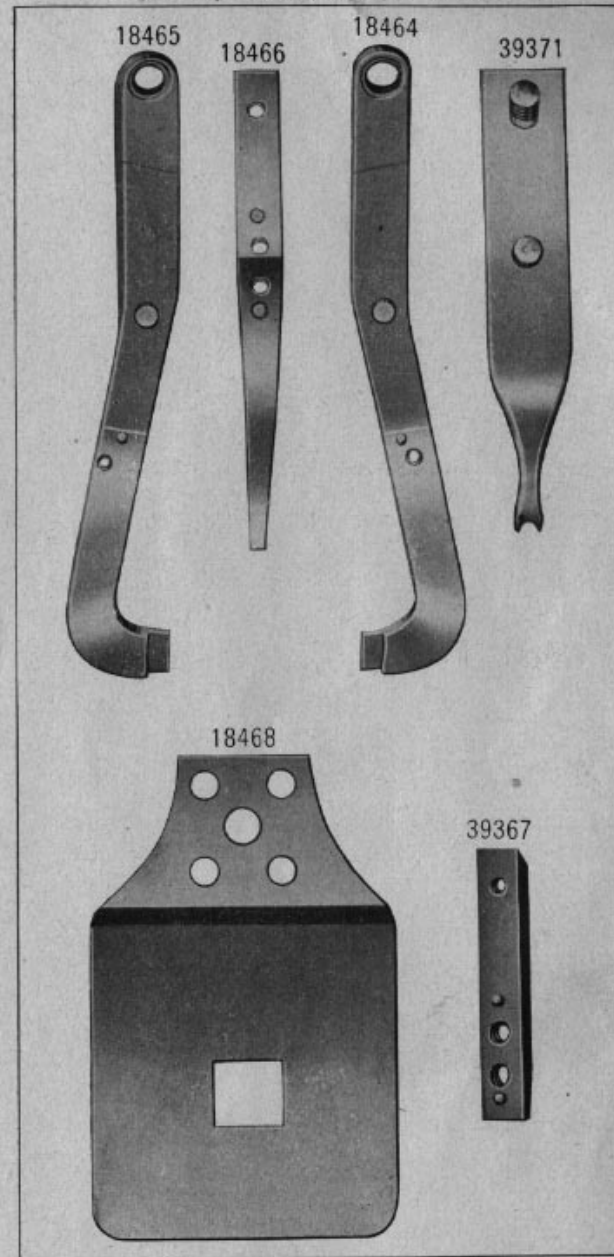

PLATE 3765—FULL SIZE

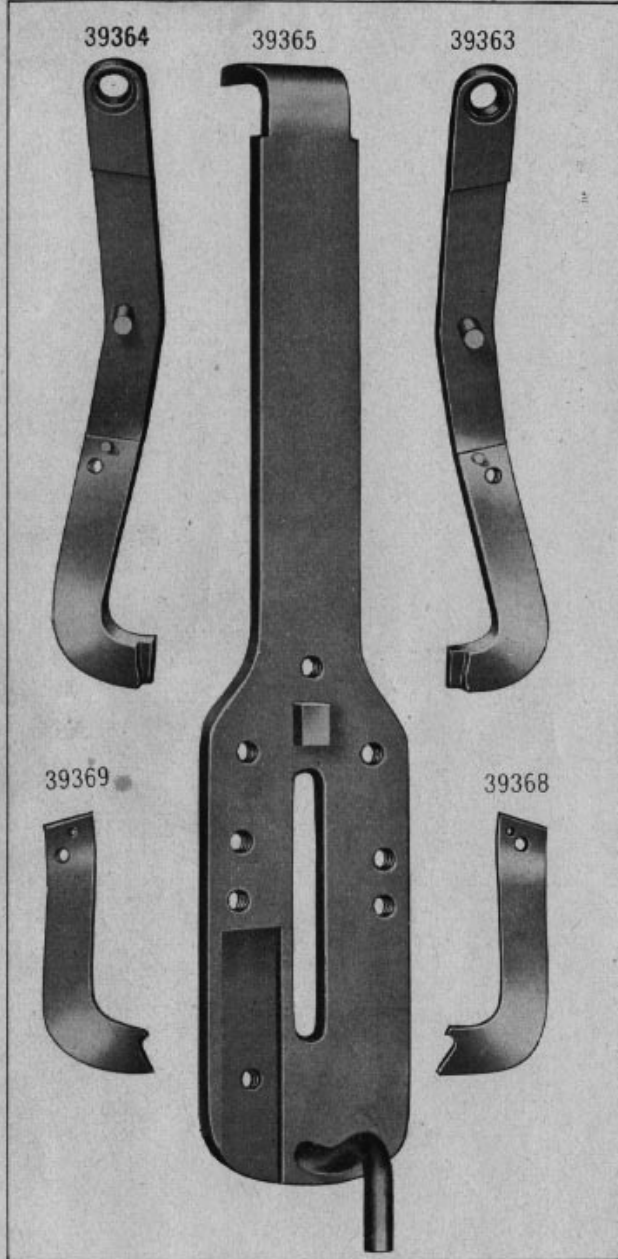
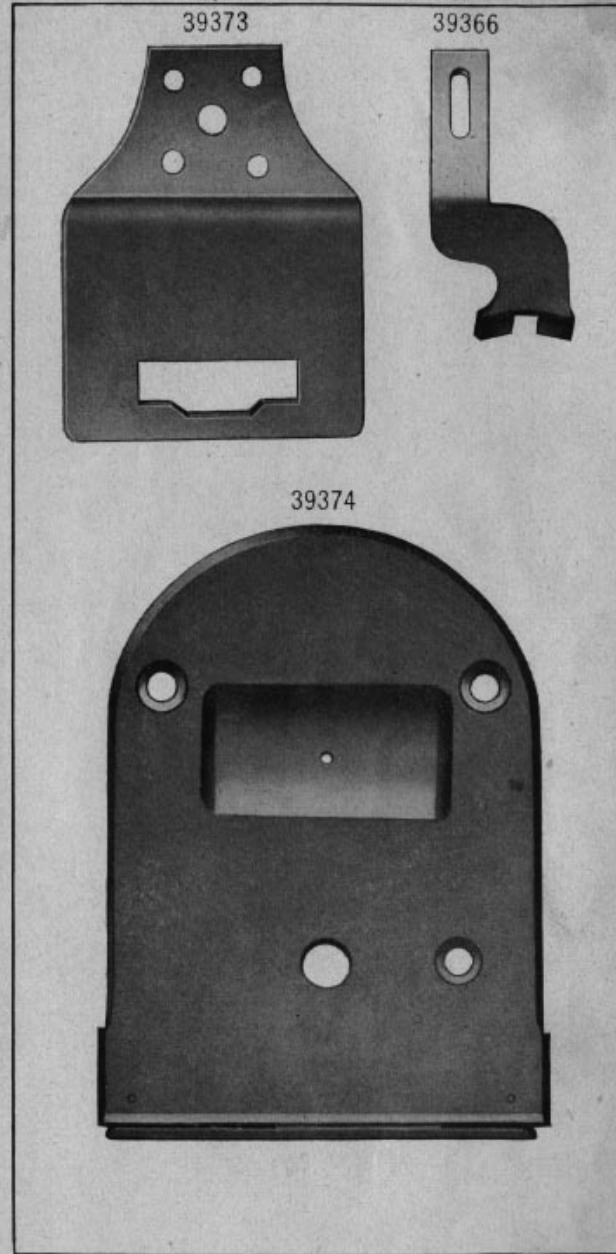

PLATE 3766—FULL SIZE



From the library of: Diamond Needle Corp

PLATE 3767—FULL SIZE

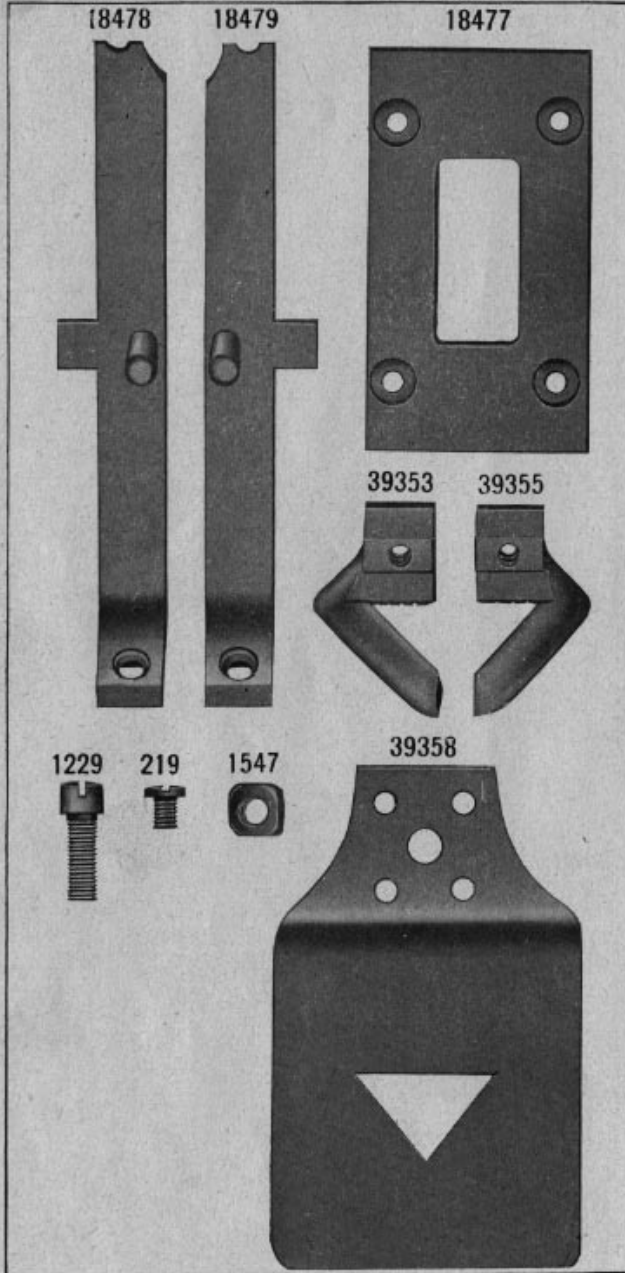
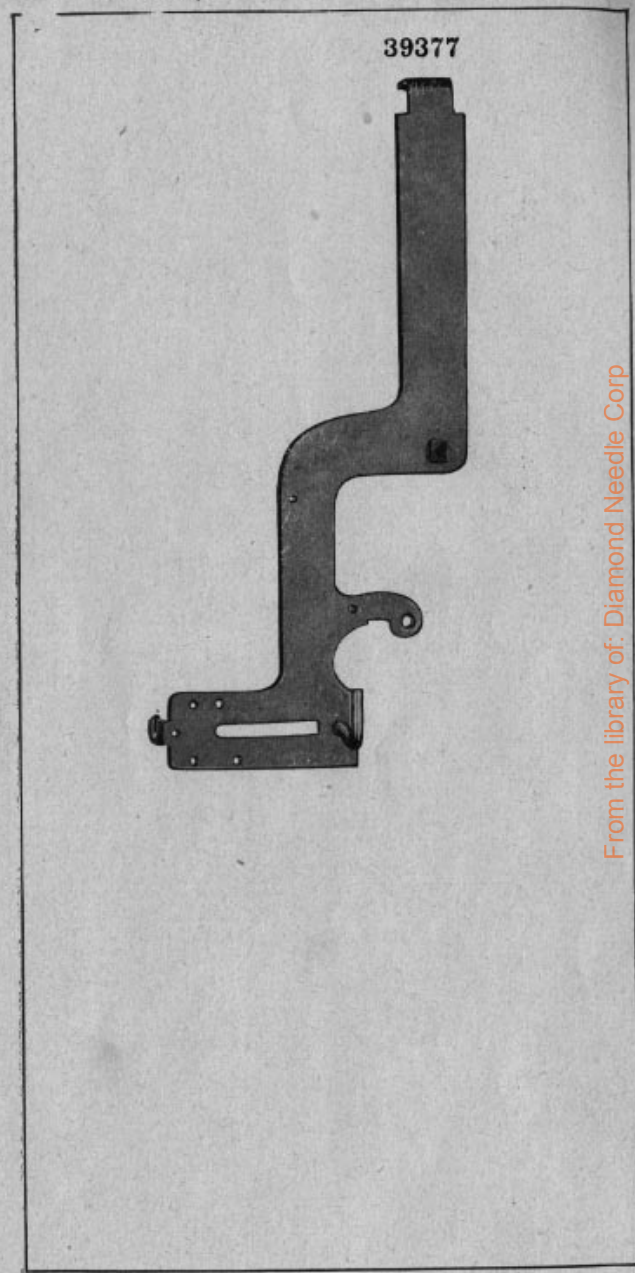

PLATE 3768—ONE-HALF SIZE



From the library of: Diamond Needle Corp

PLATE 3769—FULL SIZE

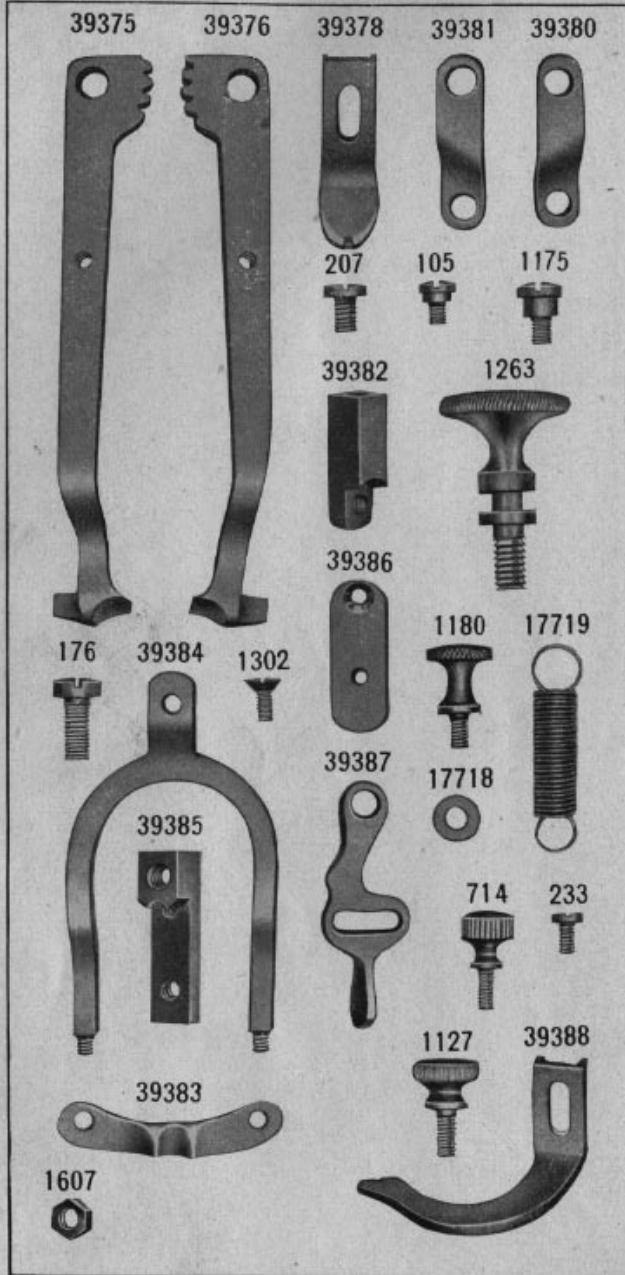
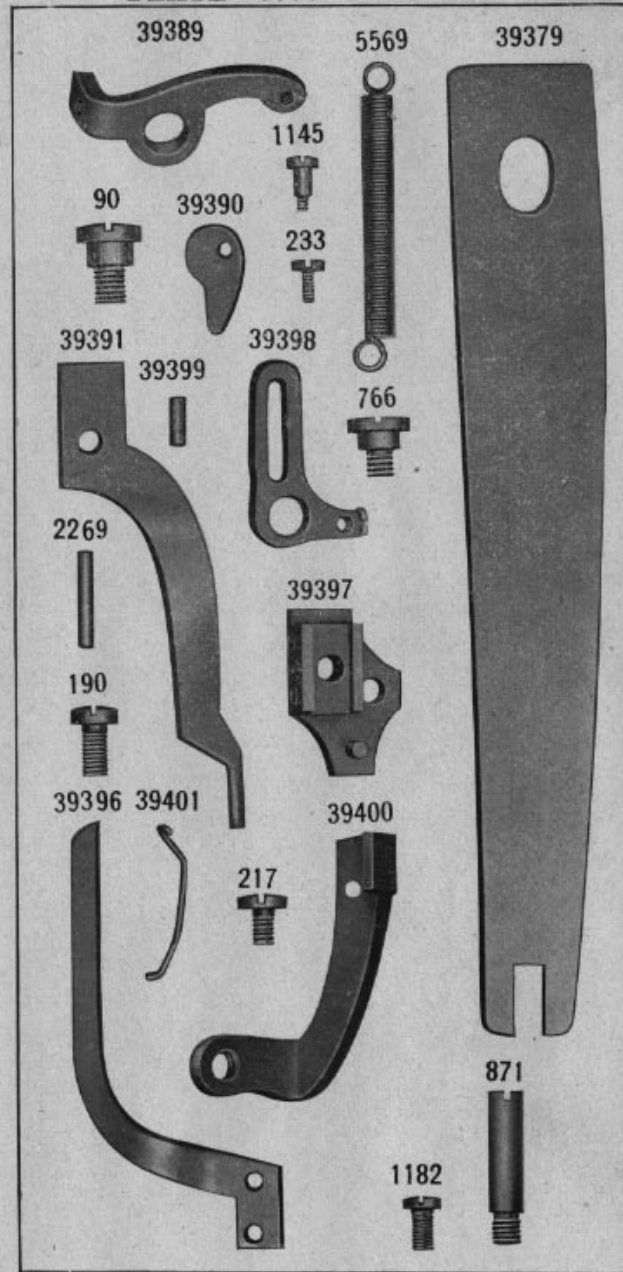

PLATE 3770—FULL SIZE



From the library of: Diamond Needle Corp

PLATE 3771—FULL SIZE

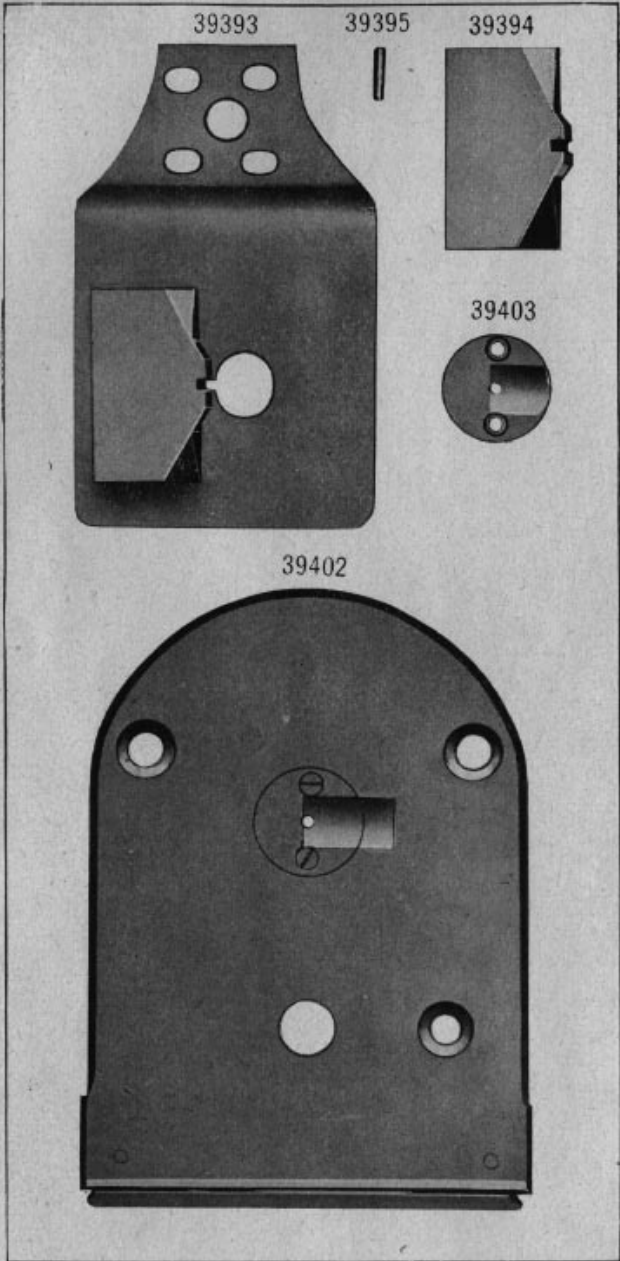
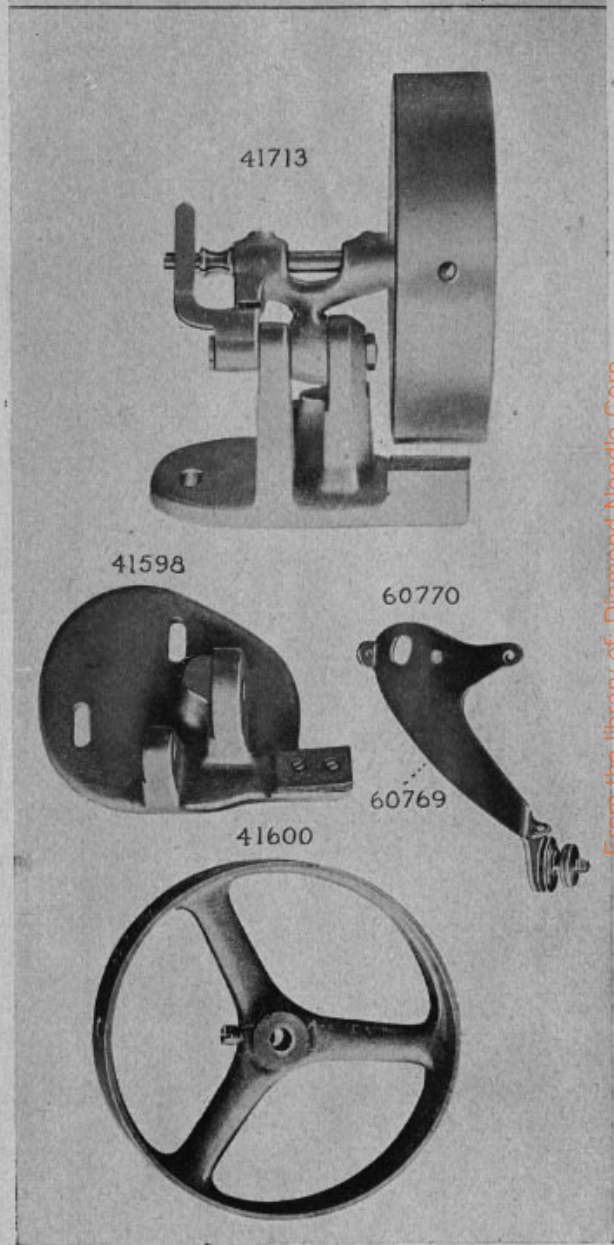

PLATE 3780—ONE-HALF SIZE



From the library of: Diamond Needle Corp

PLATE 3781—FULL SIZE

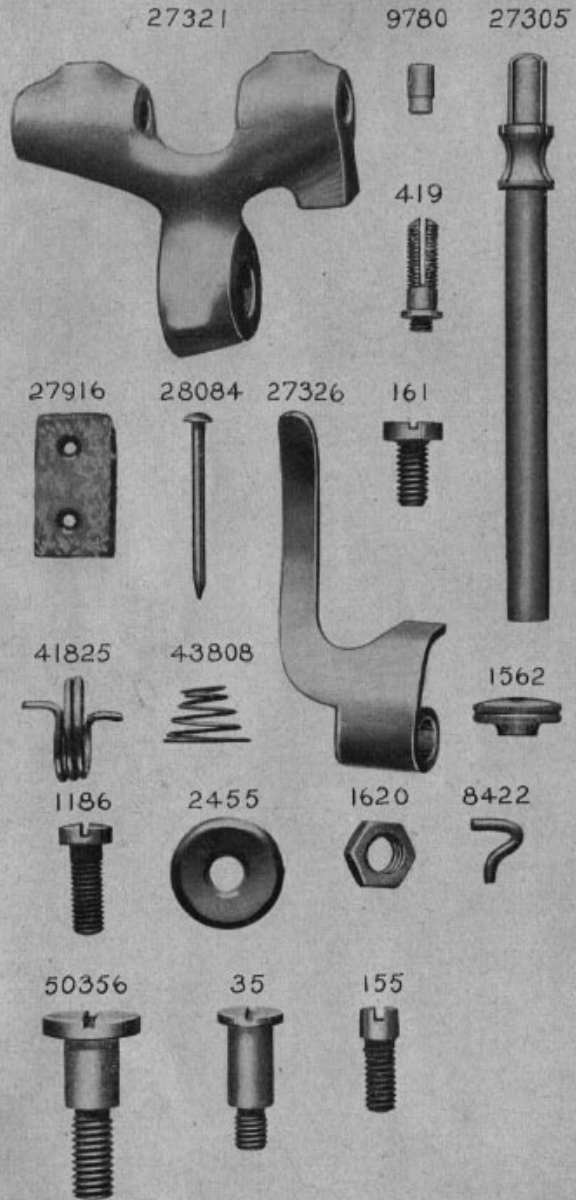

PLATE 3785—FULL SIZE

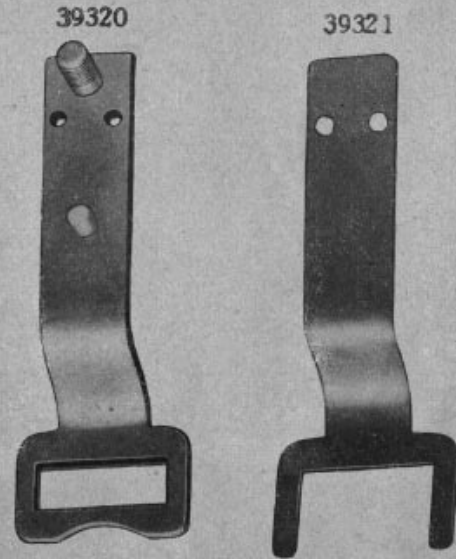

PLATE 3786—FULL SIZE

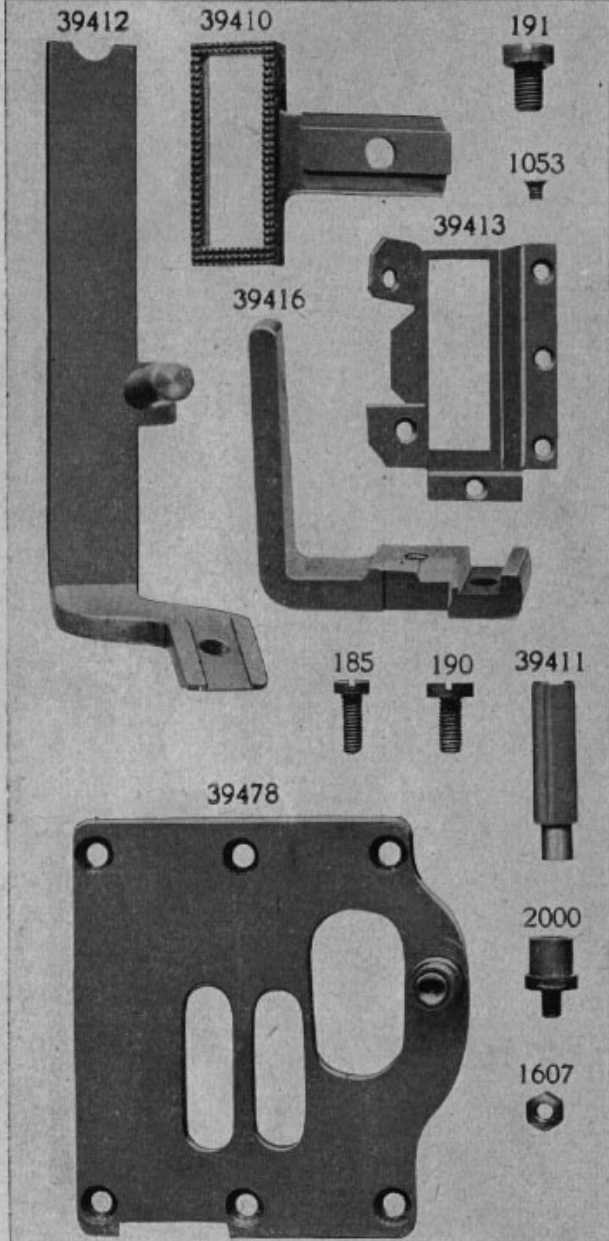
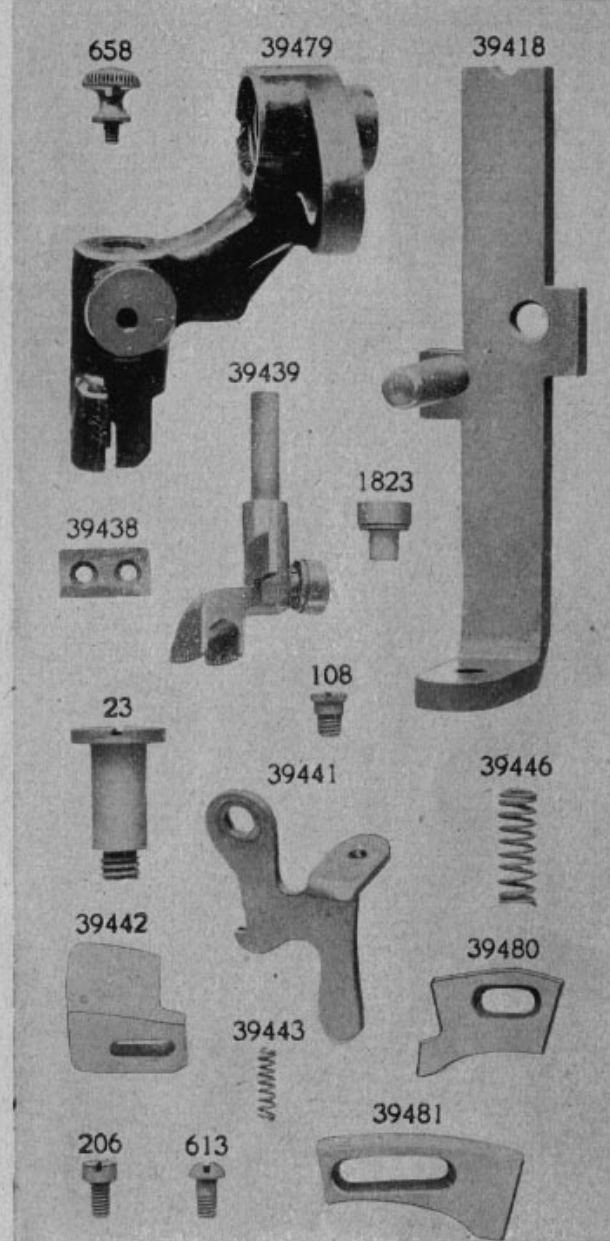
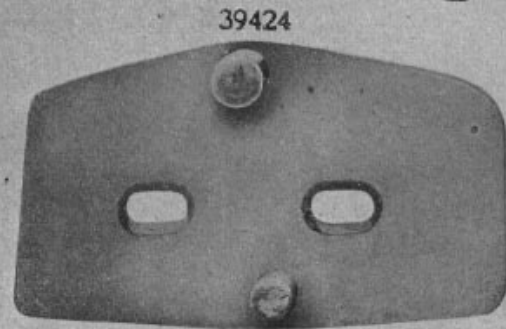
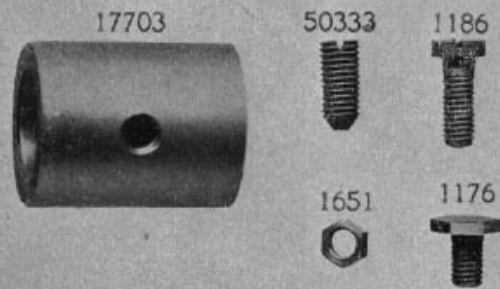
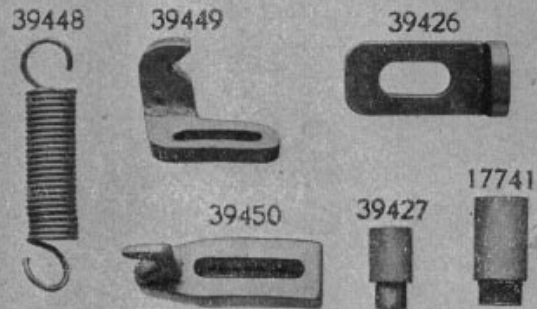
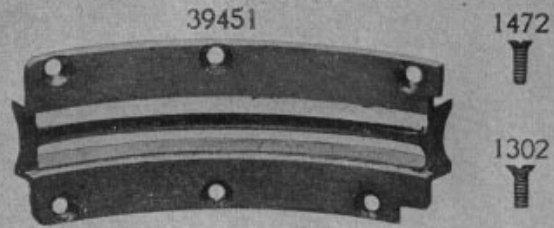

PLATE 3787—FULL SIZE



From the library of: Diamond Needle Corp

PLATE 3788—FULL SIZE



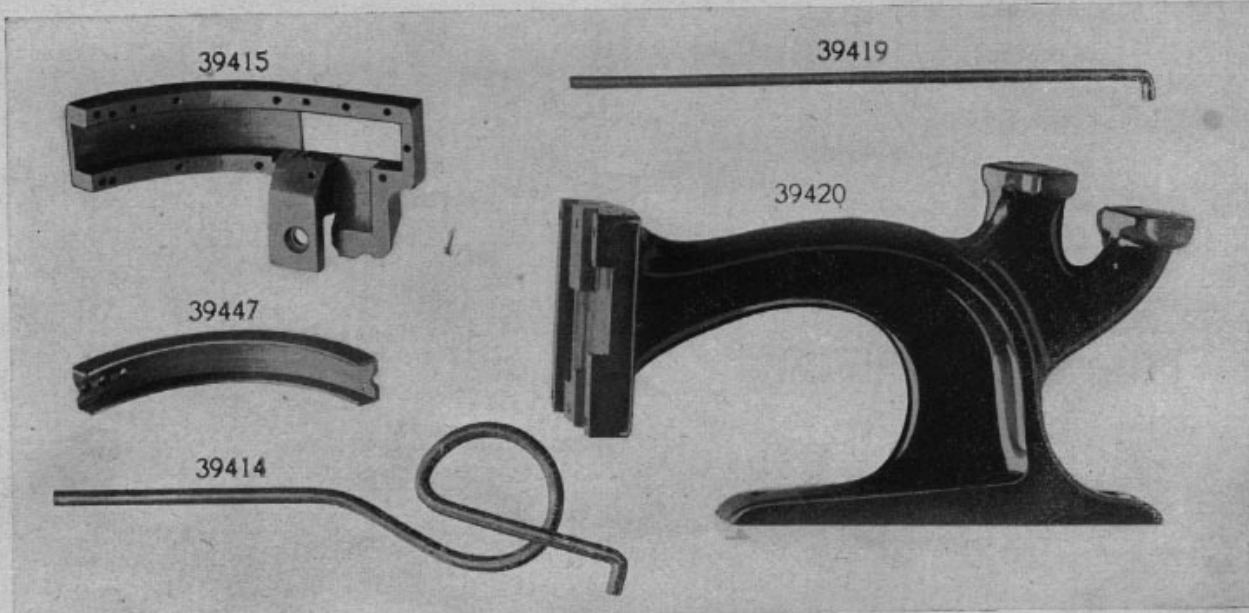

PLATE 3789—ONE-HALF SIZE

PLATE 3791—ONE-HALF SIZE

39430

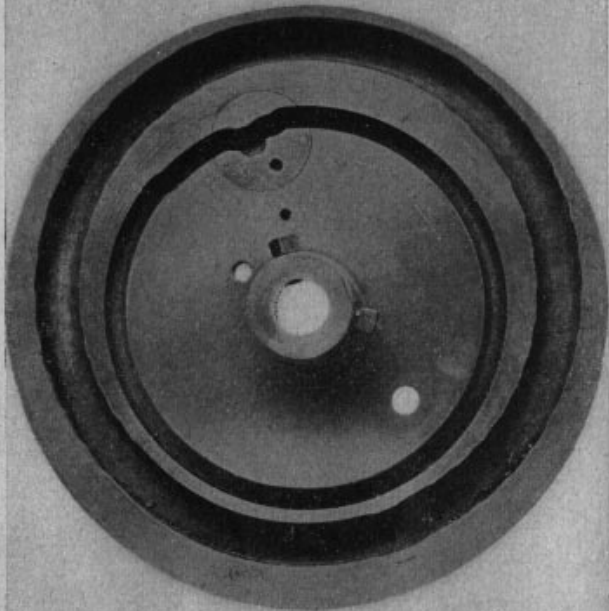
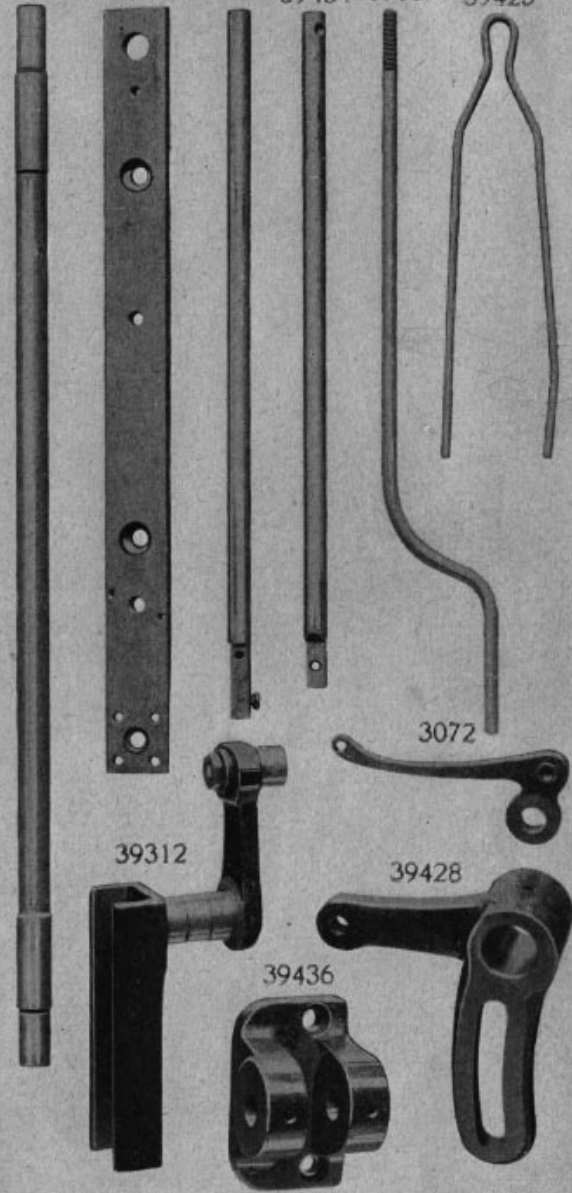

PLATE 3792—ONE-HALF SIZE

3053 39432 17831 39434 17837 39425



From the library of: Diamond Needle Corp

PLATE 3793—FULL SIZE

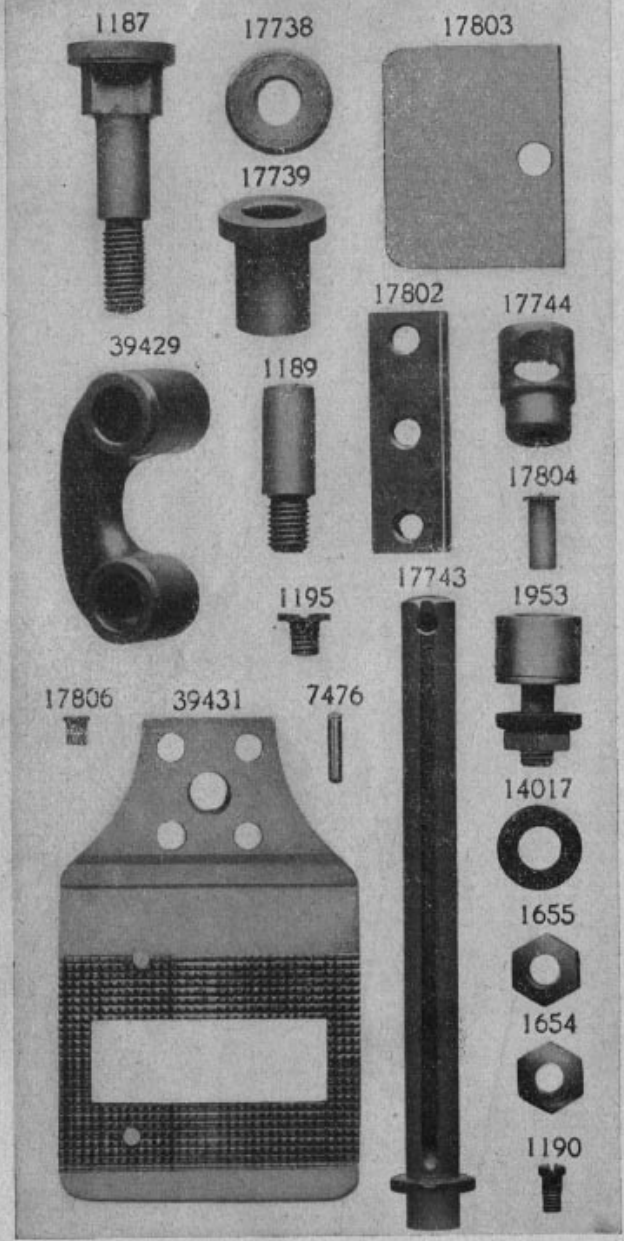

PLATE 3796—FULL SIZE



From the library of: Diamond Needle Corp

PLATE 3797—FULL SIZE

39457

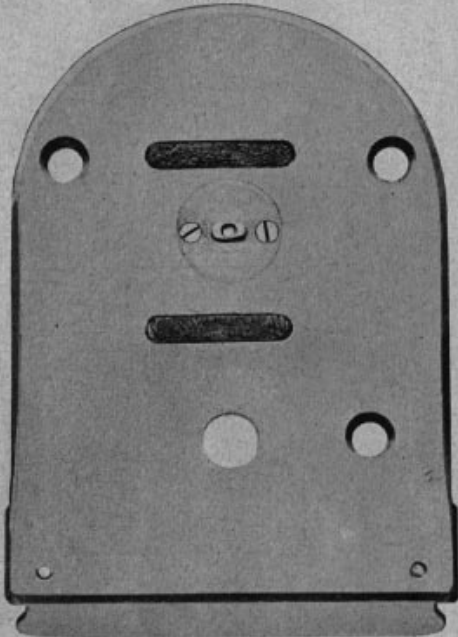

17749



39213



1208



39458



PLATE 3798—FULL SIZE

492

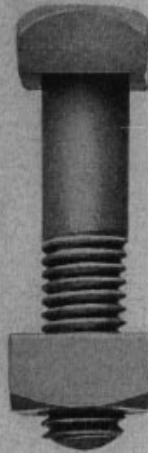

494



1385



1177



1229



168



181



1182



1318



1198



442



858



453



286



1522



1524



1547



From the library of: Diamond Needle Corp

PLATE 3799—ONE-HALF SIZE

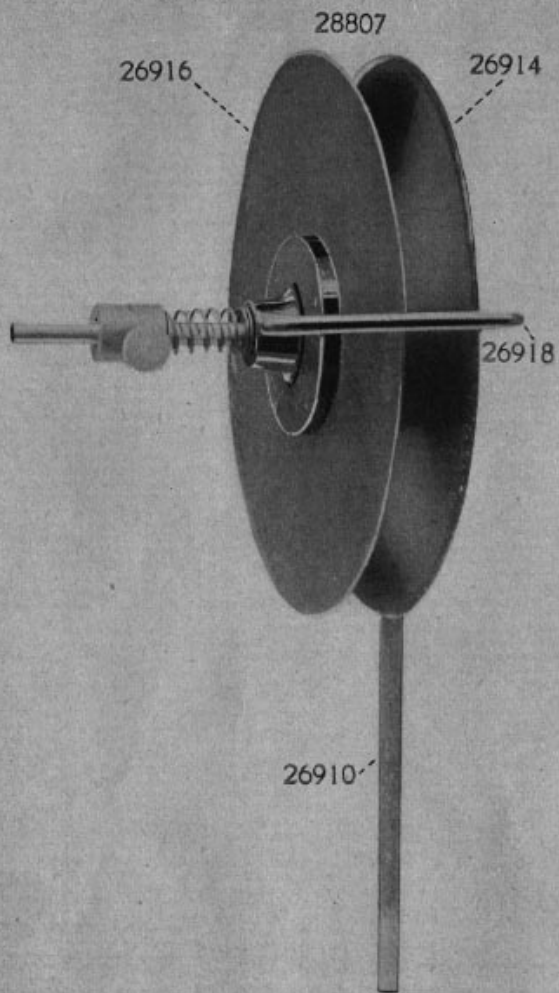

PLATE 4079—ONE-HALF SIZE

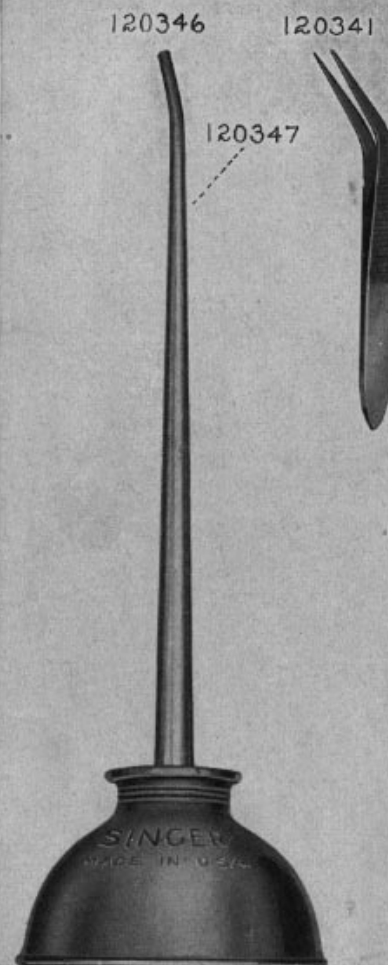
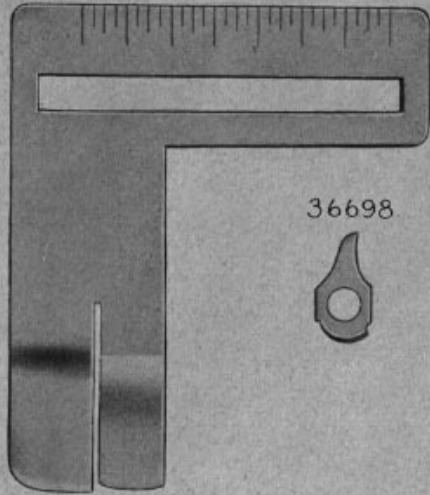

PLATE 5697—FULL SIZE

36697

2049



36698



PLATE 7008—ONE-HALF SIZE

39494

39496

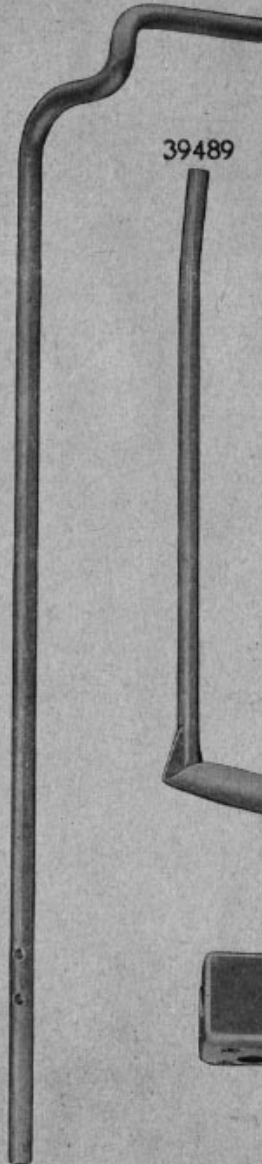

39489

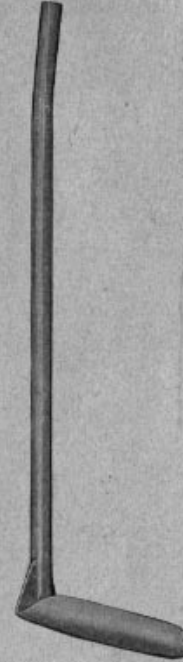

39491



From the library of: Diamond Needle Corp

PLATE 7009—FULL SIZE

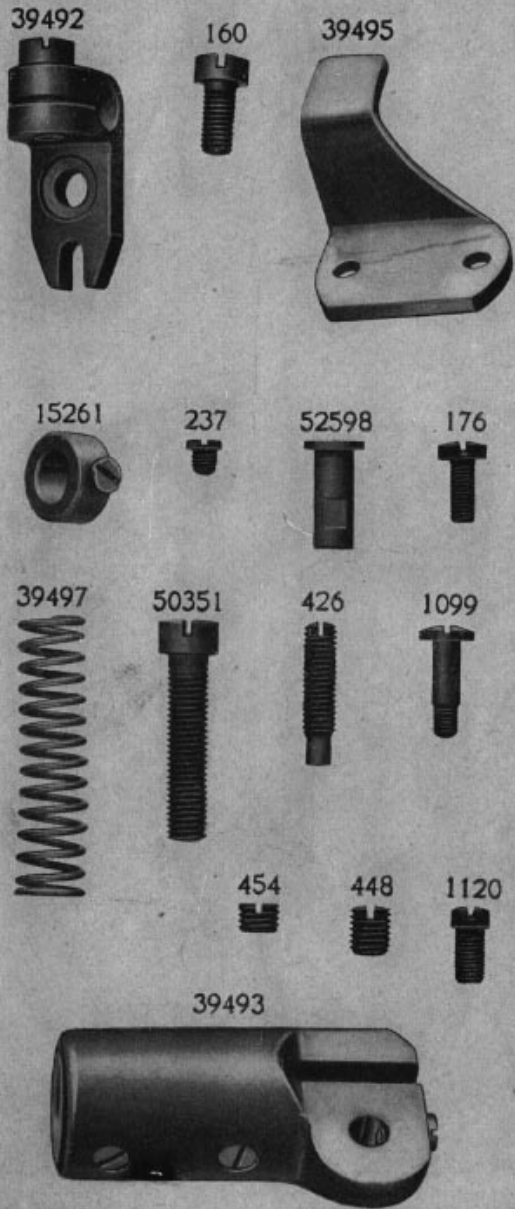

PLATE 7200—ONE-HALF SIZE



From the library of: Diamond Needle Corp

PLATE 7202—ONE-FOURTH SIZE

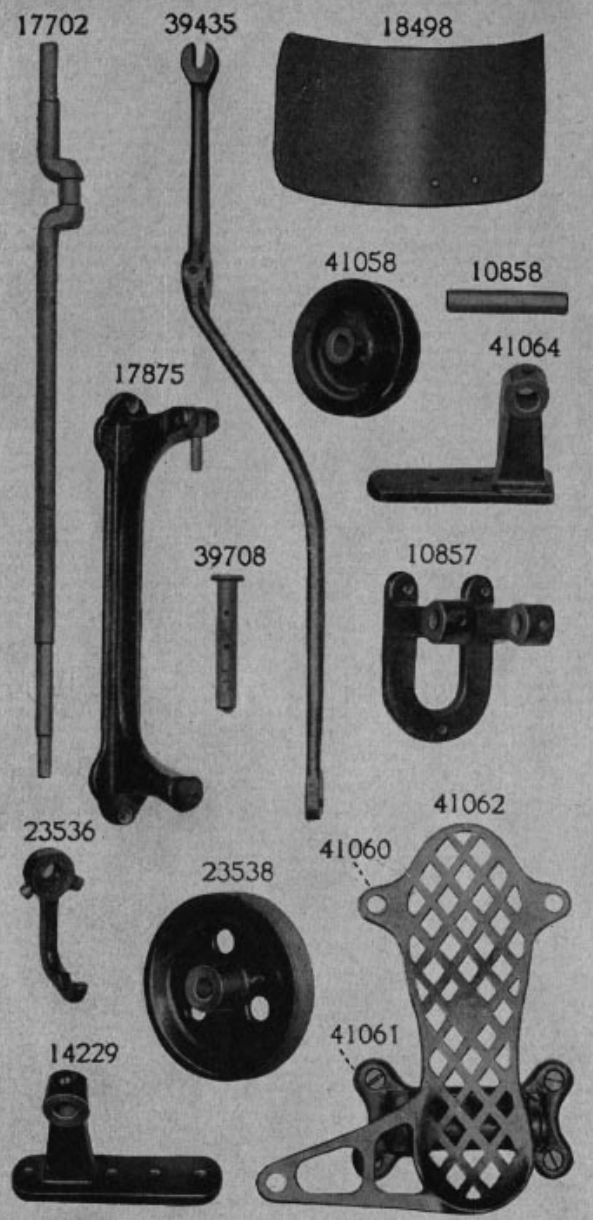
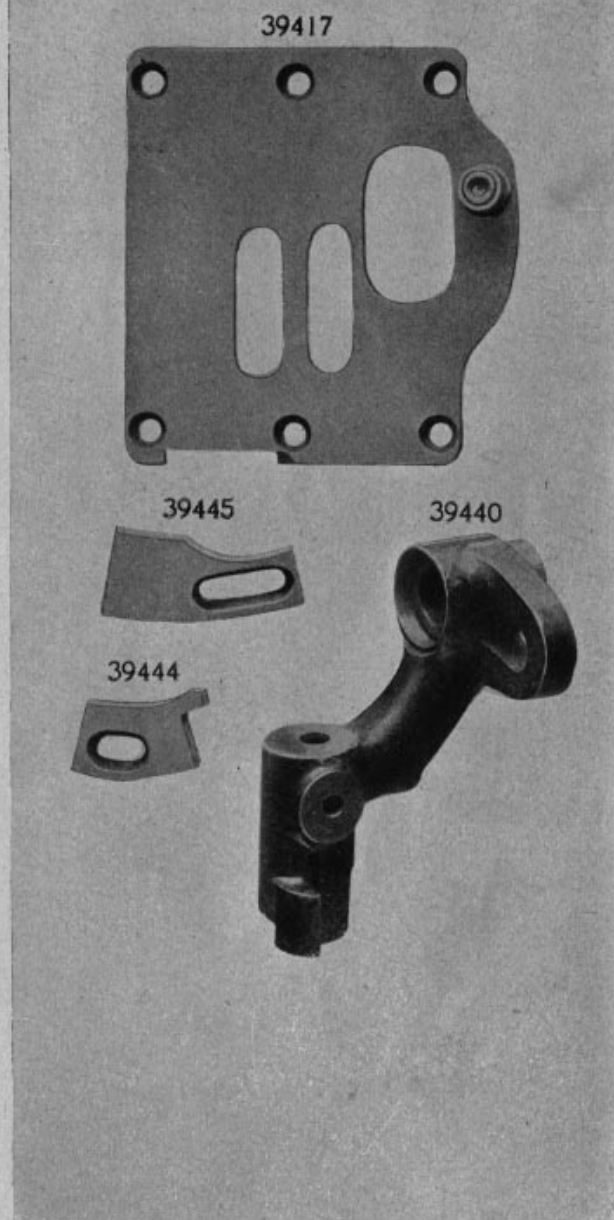

PLATE 7204—FULL SIZE



From the library of: Diamond Needle Corp

PLATE 7205—ONE-HALF SIZE

63811

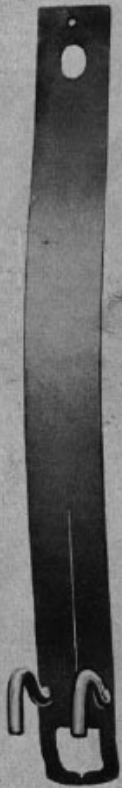

63812



63927



63788

PLATE 7206—FULL SIZE

63724



63725



63731



63732



63808



63810



63726



63757

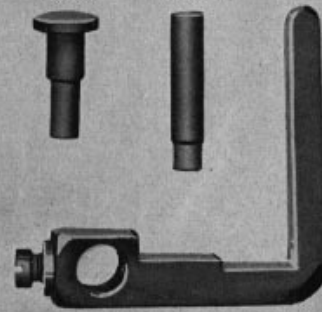

1340



From the library of: Diamond Needle Corp

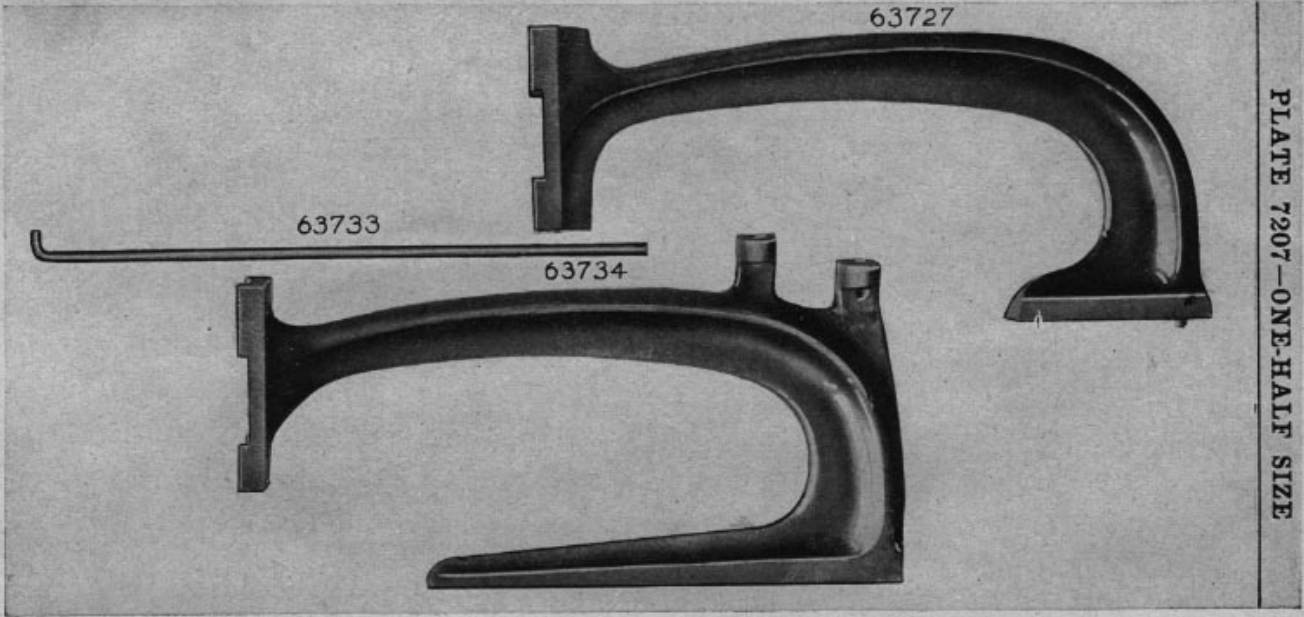
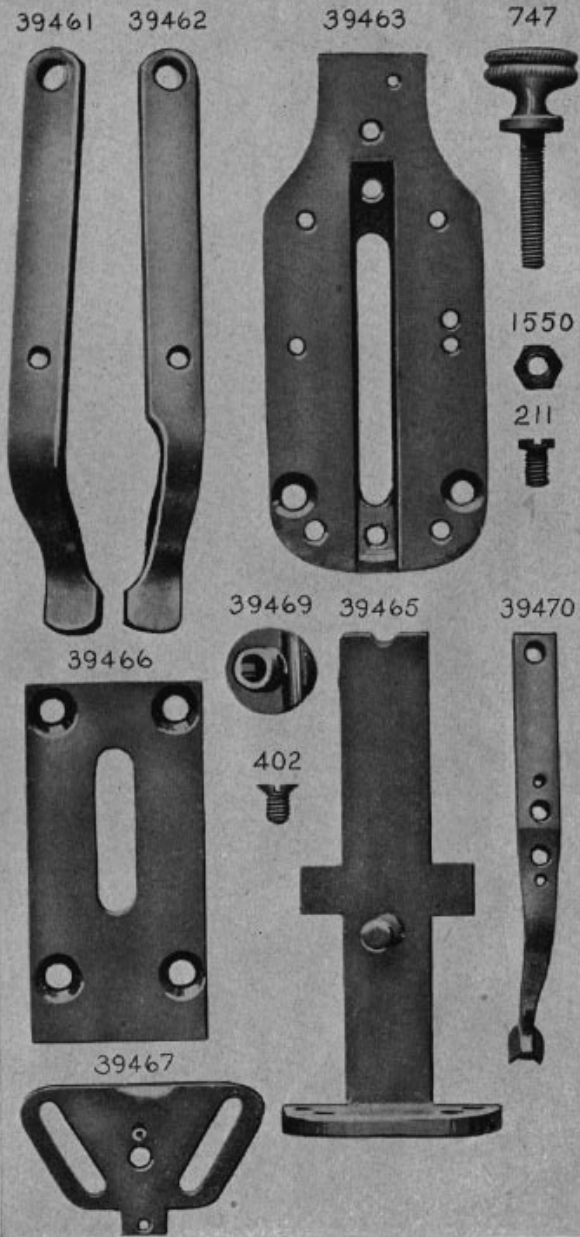

PLATE 7207—ONE-HALF SIZE

PLATE 7208—FULL SIZE



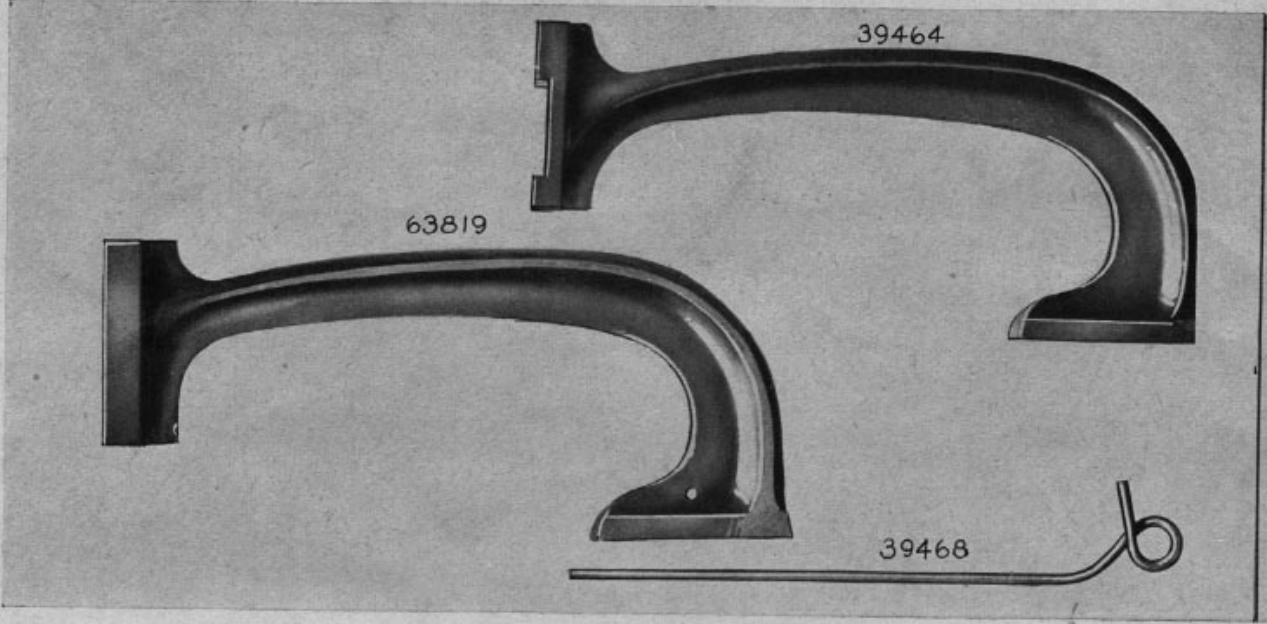
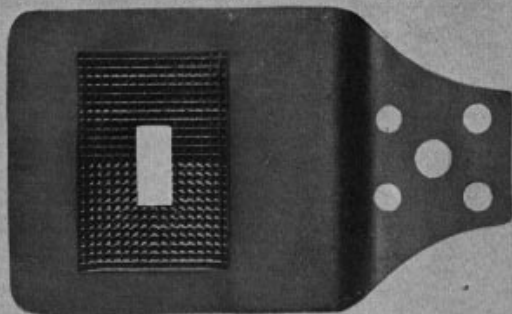

PLATE 7209—ONE-HALF SIZE

PLATE 7210—FULL SIZE

18459



63701

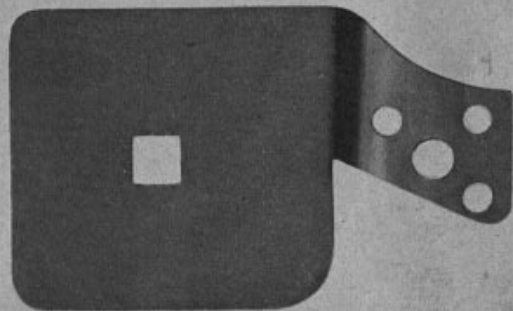

63831

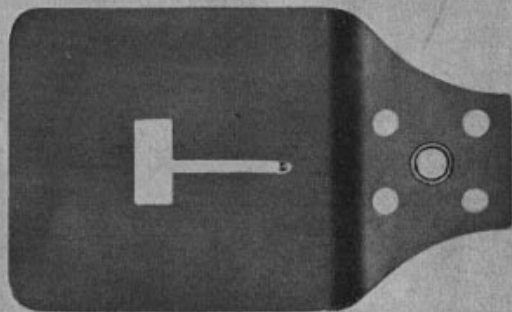

PLATE 7211—ONE-HALF SIZE

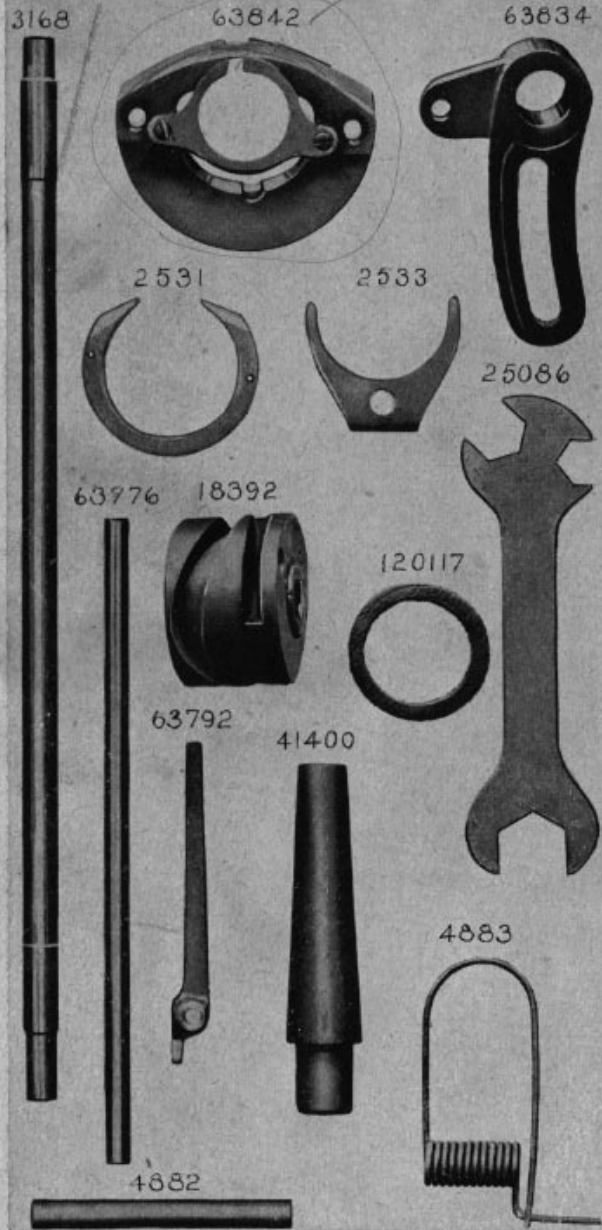
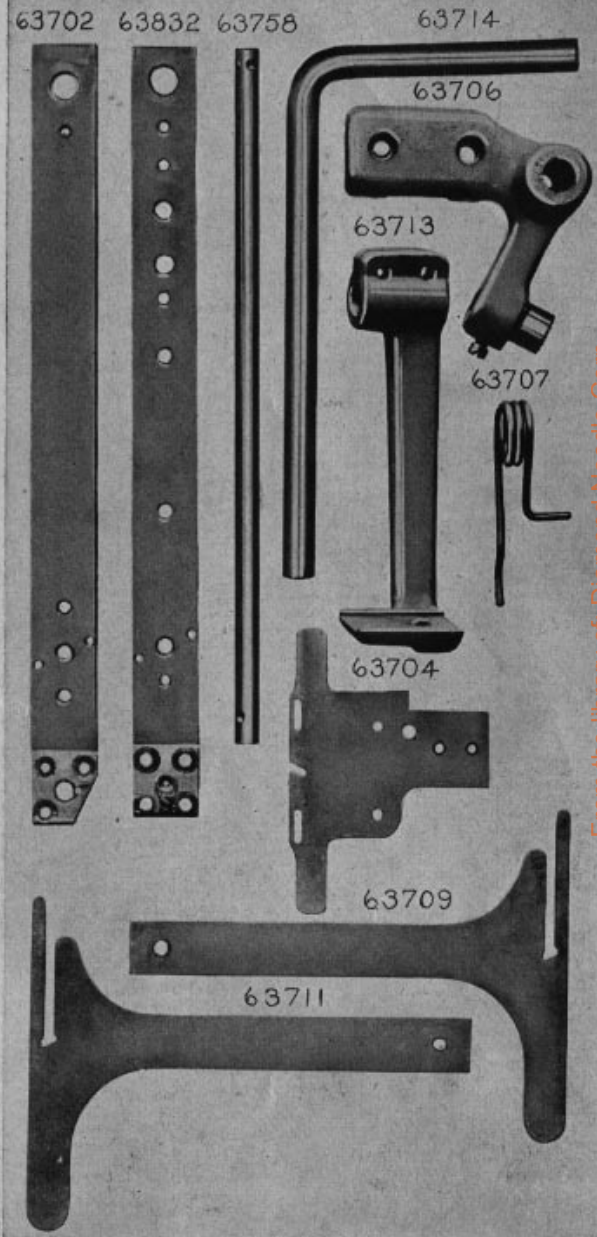

PLATE 7212—ONE-HALF SIZE



From the library of Diamond Needle Corp

PLATE 7213—FULL SIZE

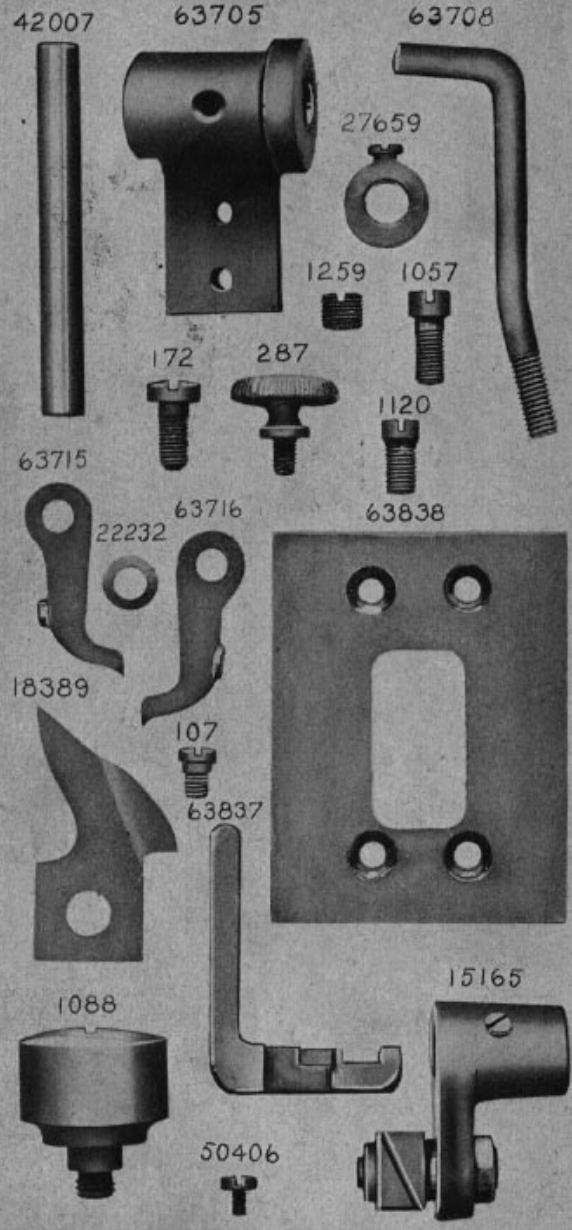
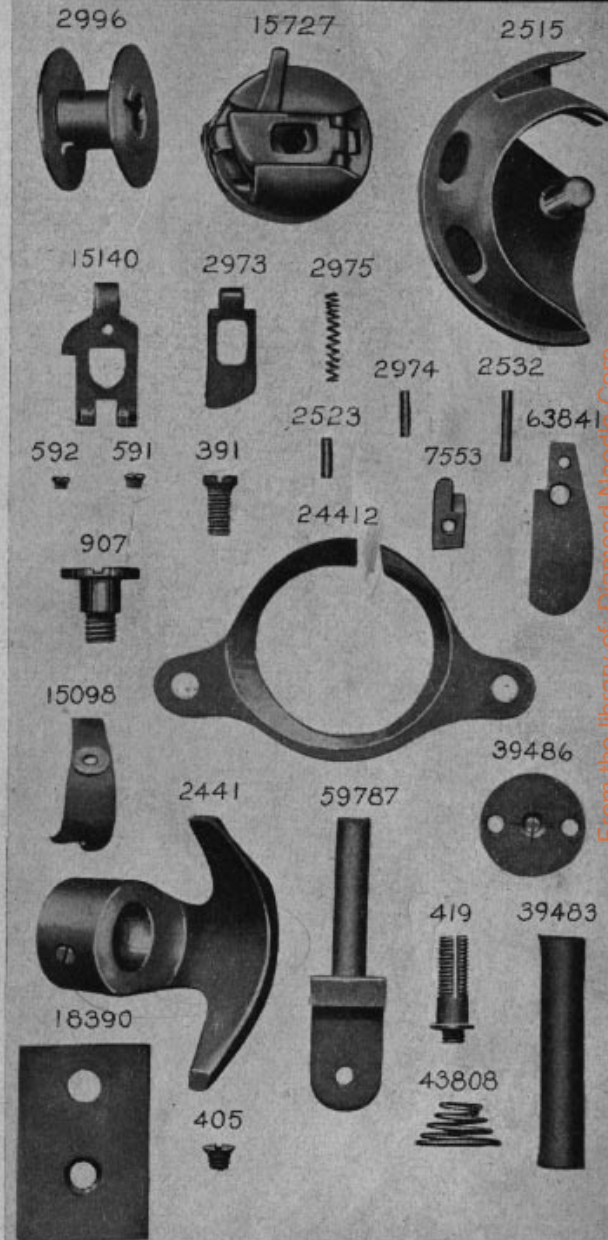

PLATE 7214—FULL SIZE



From the library of: Diamond Needle Corp

PLATE 7215—FULL SIZE

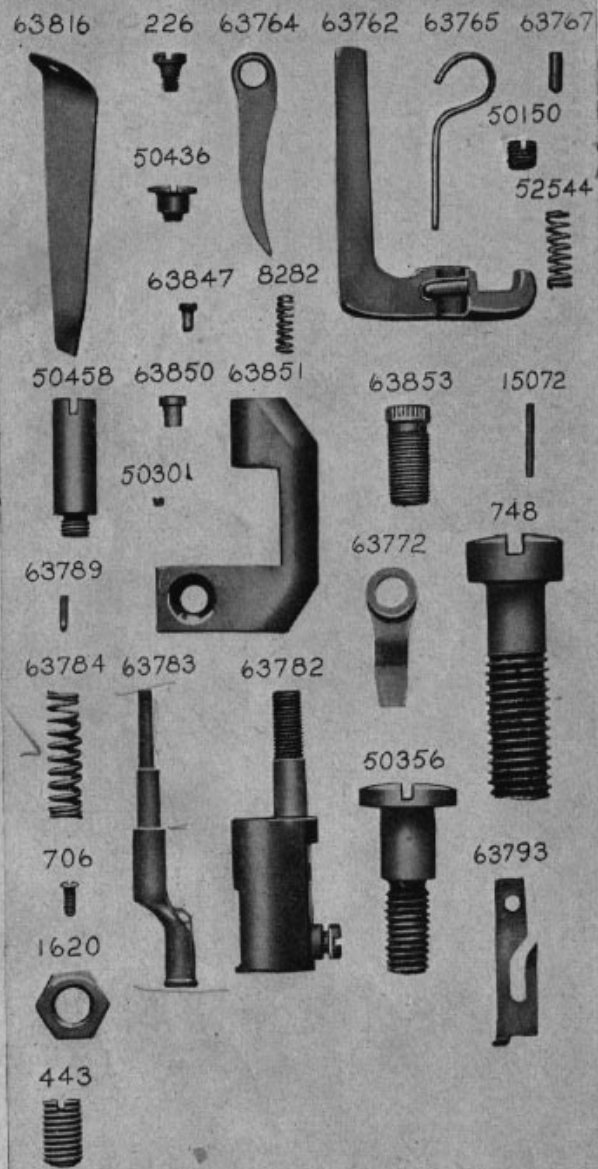
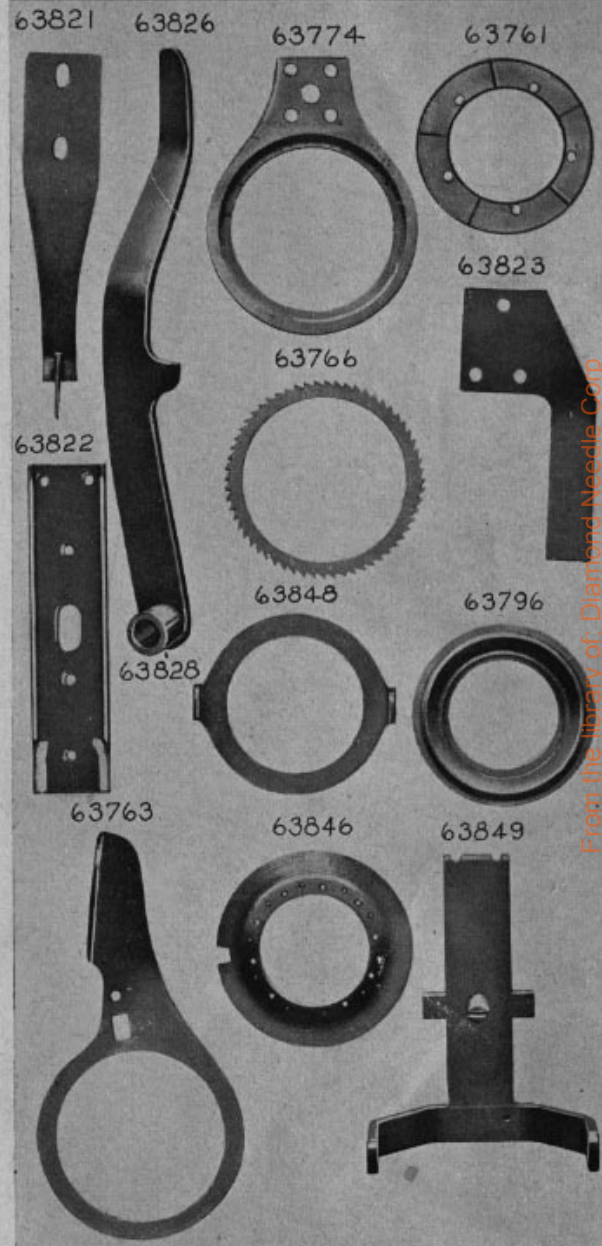

PLATE 7216—ONE-HALF SIZE



From the library of: Diamond Needle Corp

PLATE 7217—FULL SIZE

63791

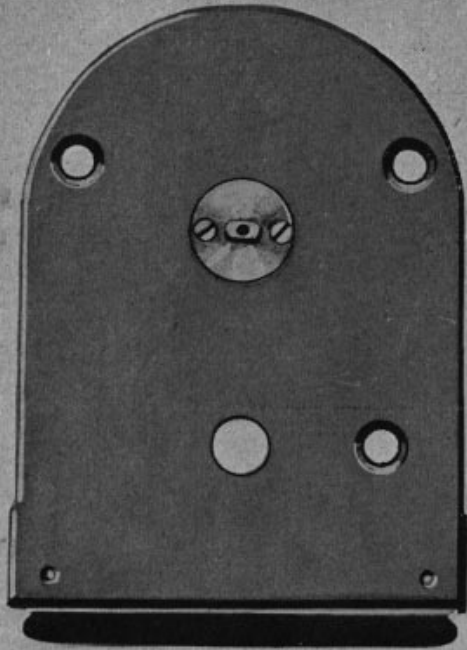

63790

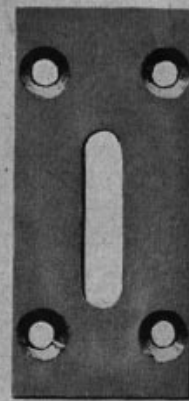

PLATE 7218—FULL SIZE

63817



63818



63827



199



63836

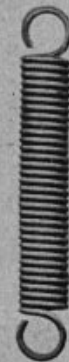

63824



50130



63825



63829



780



1600



From the library of: Diamond Needle Corp

PLATE 7234—ONE-HALF SIZE

27739



225390

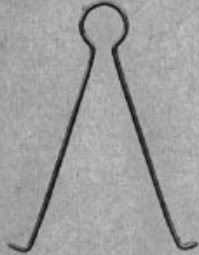
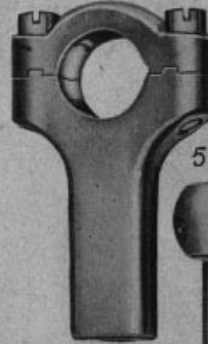

PLATE 7235—FULL SIZE

63940



896



63942



55381



63944



63976

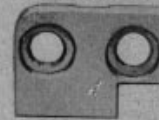

50599



50682



46244

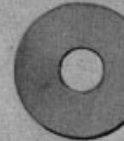

33942



15278



1114



56865



201018



200383



201696



225393



From the library of: Diamond Needle Corp

PLATE 7236—ONE-HALF SIZE

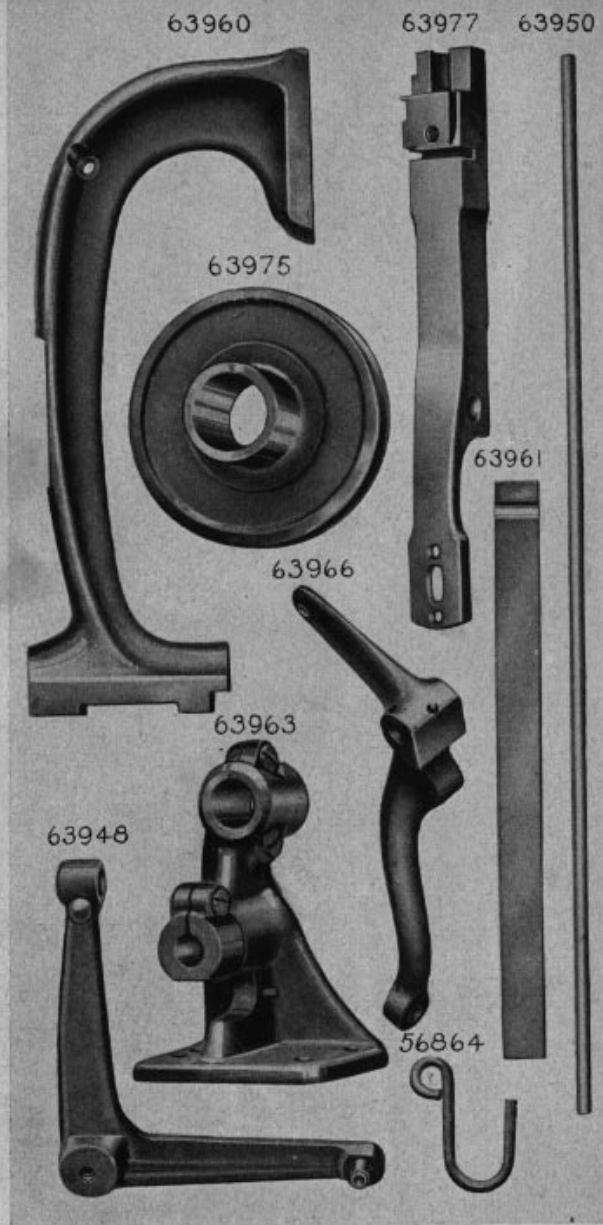
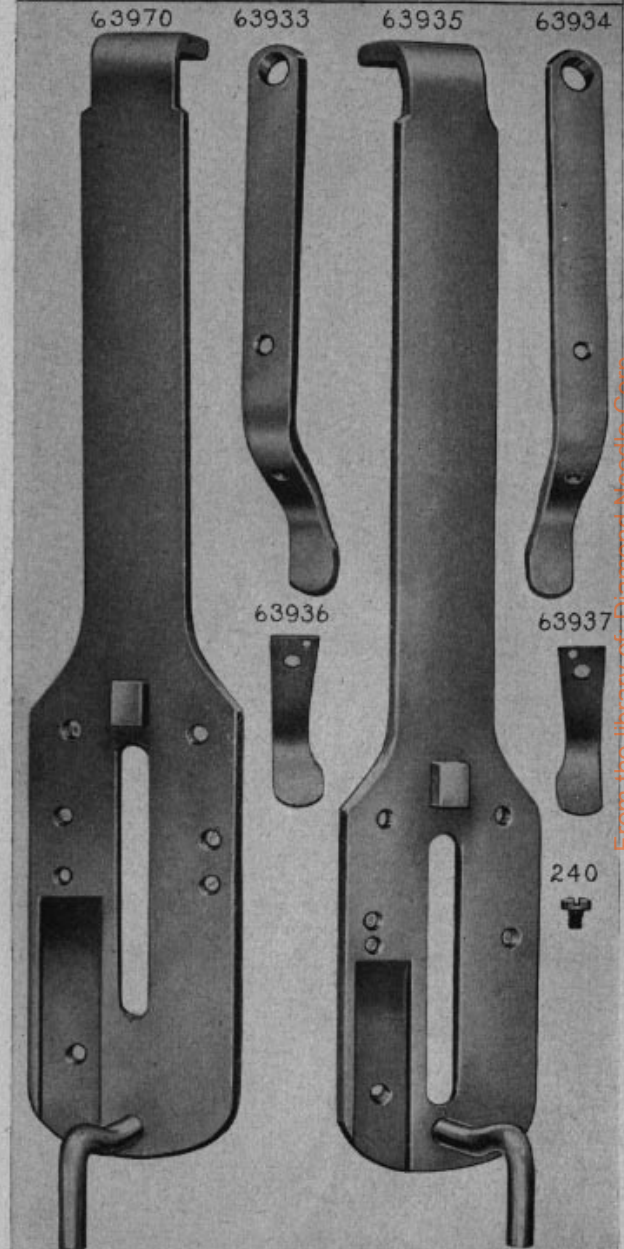

PLATE 7237—FULL SIZE



From the library of: Diamond Needle Corp

PLATE 7238—FULL SIZE

63930

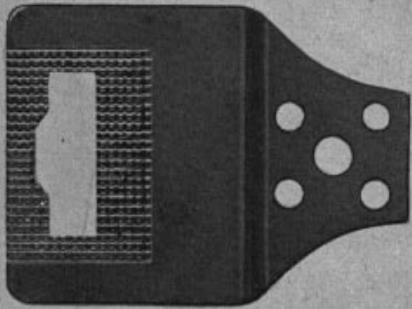

63931

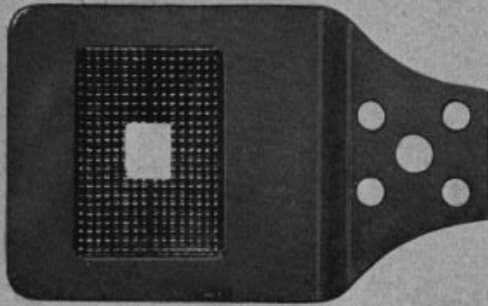

63932

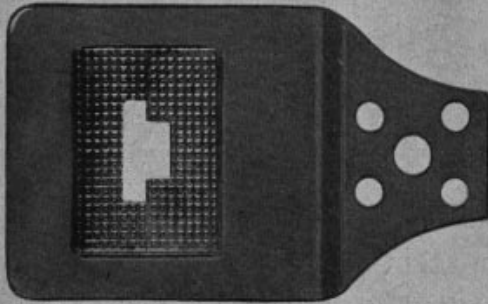
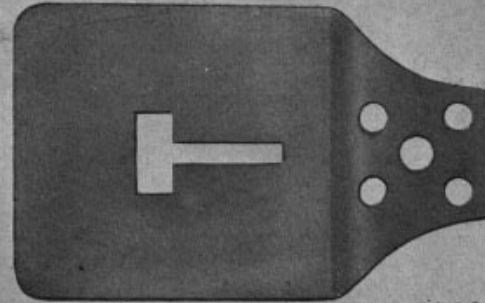

PLATE 7239—FULL SIZE

63965



63938



63947

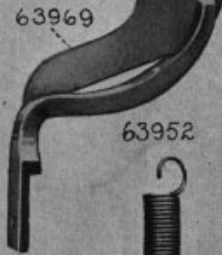

63969

63952

63949

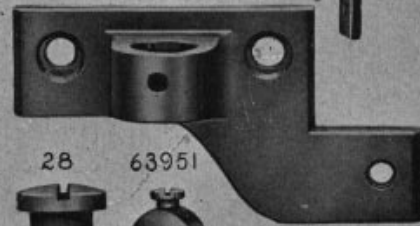

28



63951



9281

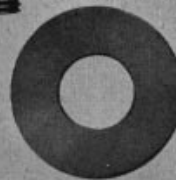

51853



63979



183



63980



From the library of: Diamond Needle Corp

PLATE 7240—FULL SIZE

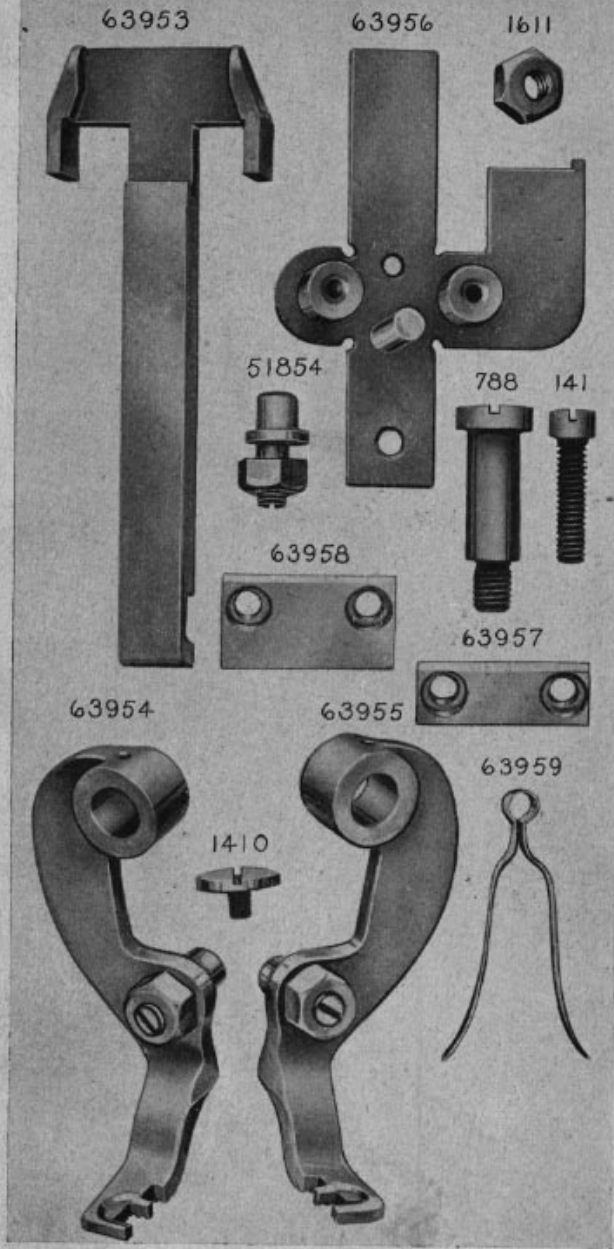
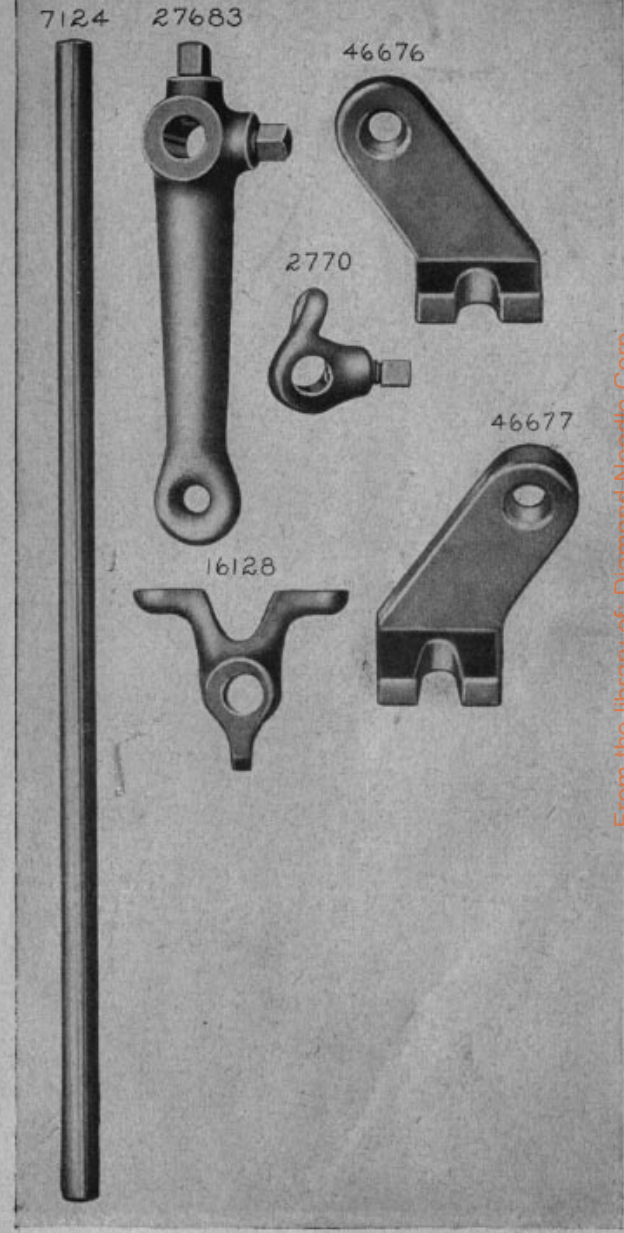

PLATE 7242—ONE-HALF SIZE



From the library of: Diamond Needle Corp

PLATE 20333—FULL SIZE

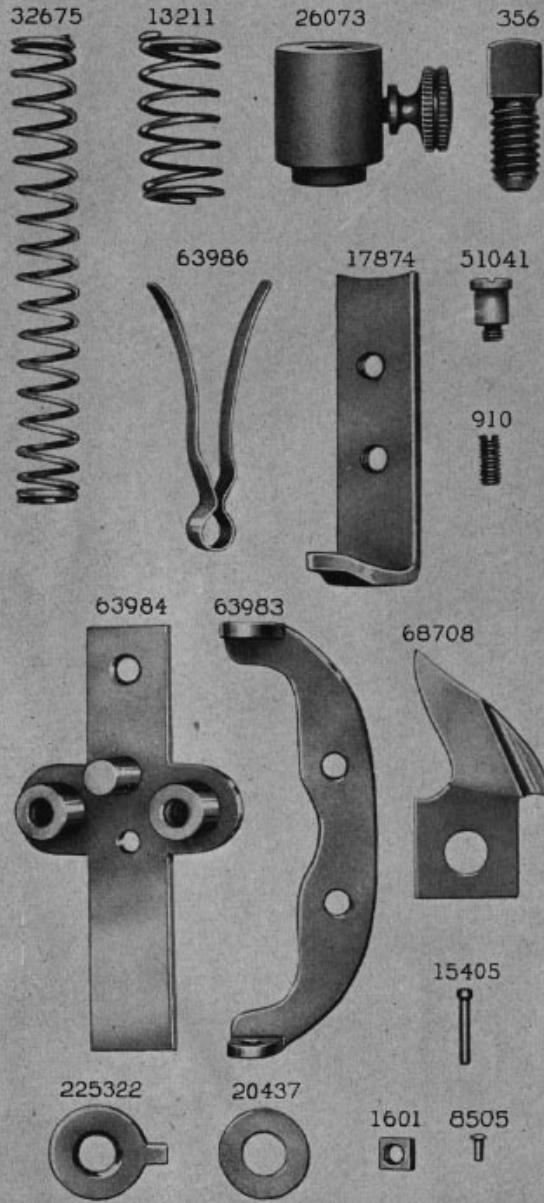

PLATE 20334—ONE-HALF SIZE

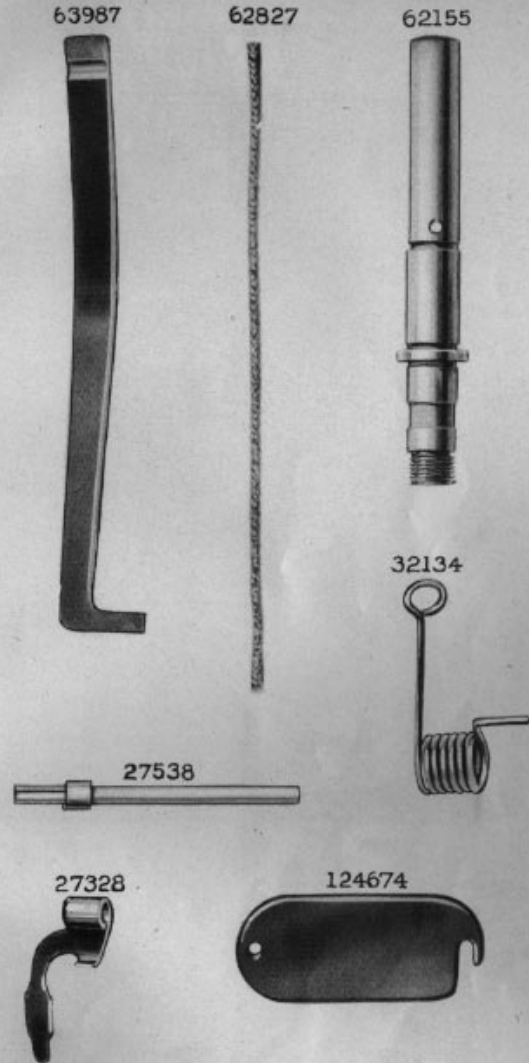

PLATE 20335 - ONE-SIXTH SIZE

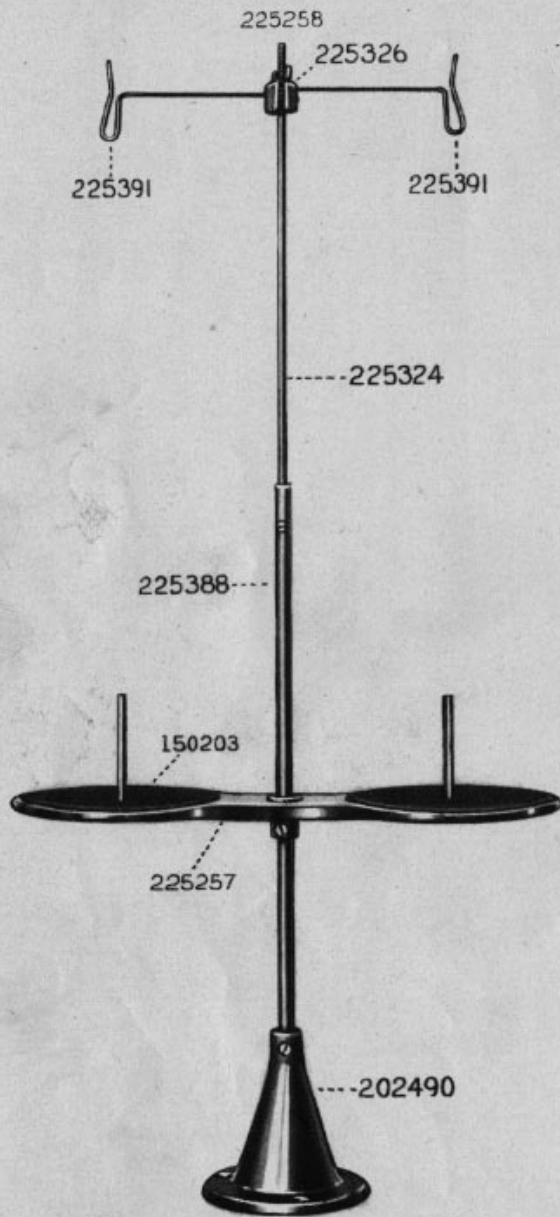

PLATE 20339 - FULL SIZE



From the library of: Diamond Needle Corp

PLATE 20340 - ONE-HALF SIZE

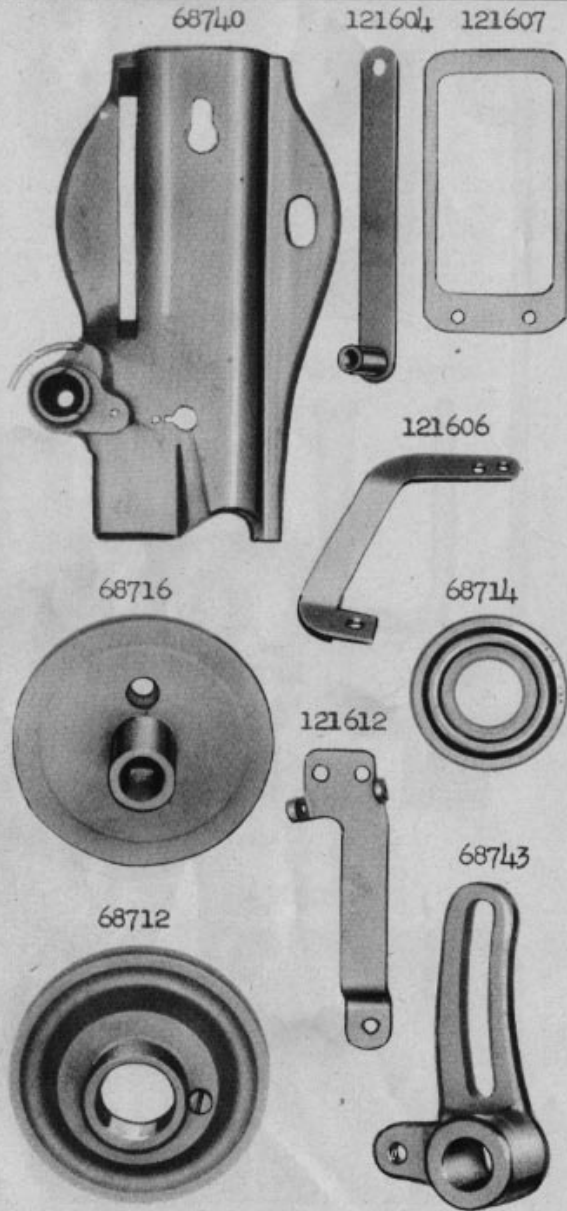
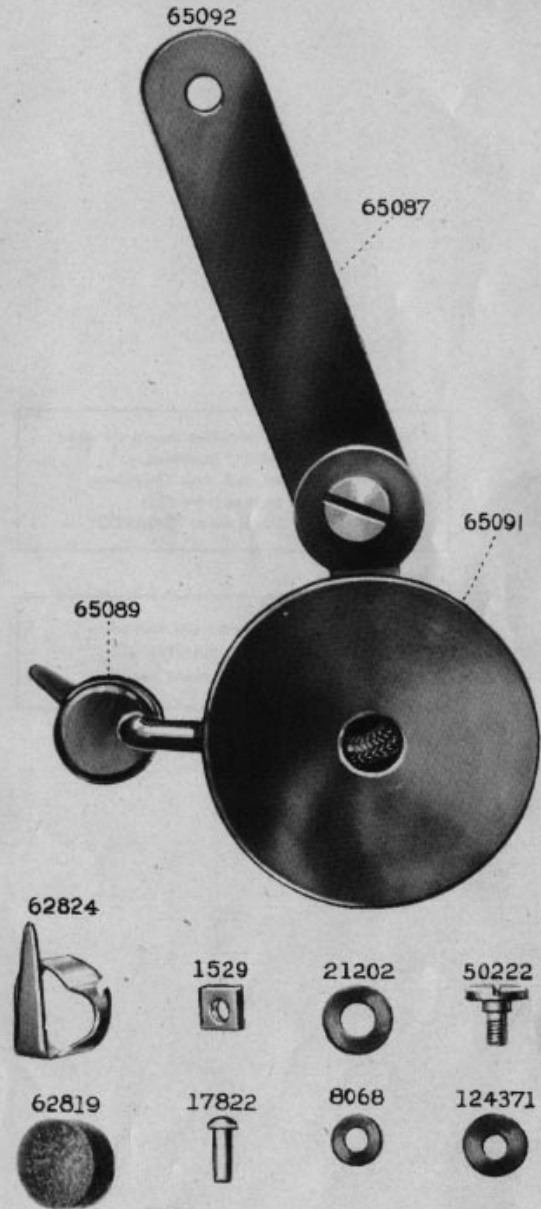

PLATE 20884 - FULL SIZE



From the library of: Diamond Needle Corp